

jandel

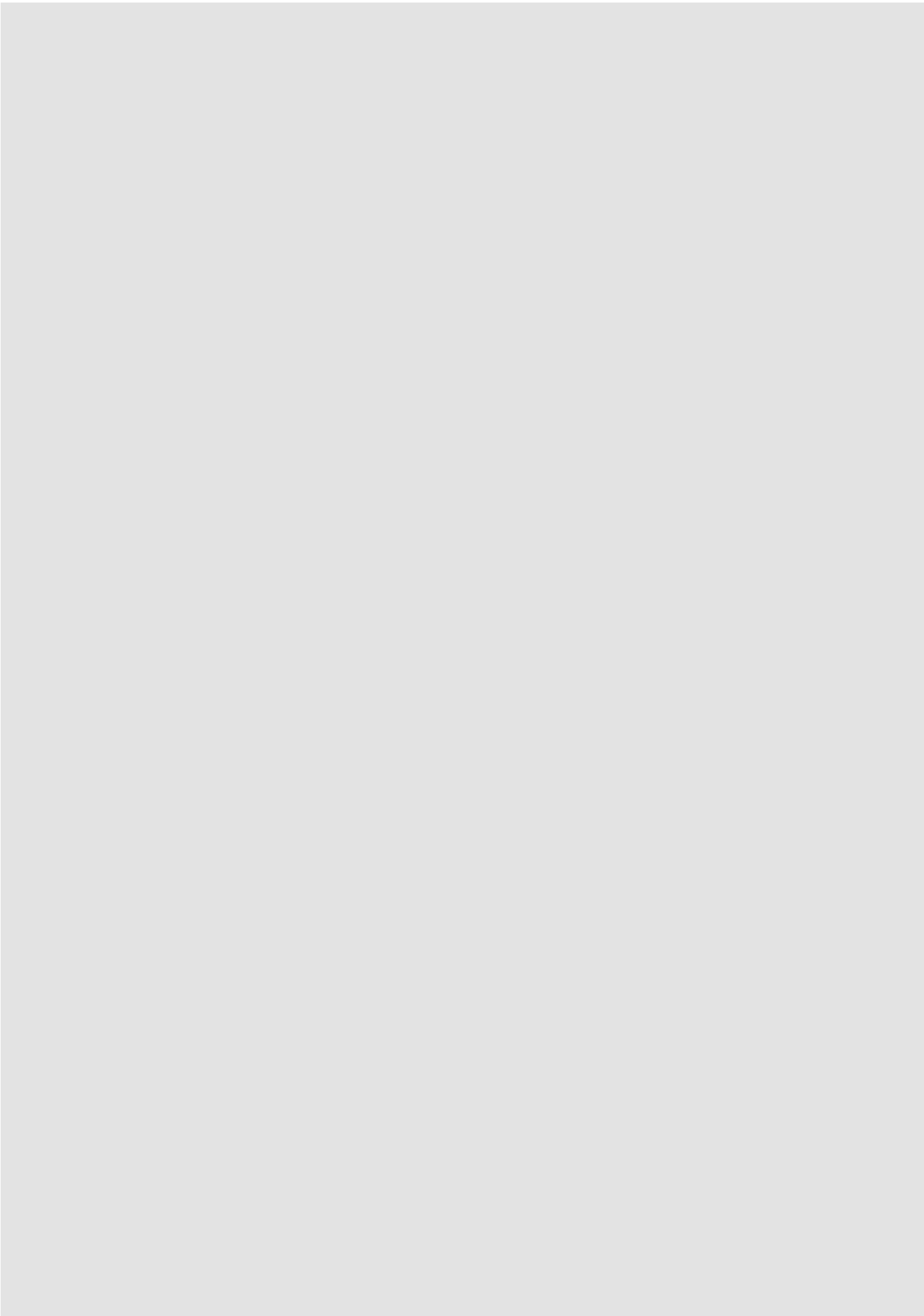

¡ Bienvenido a casa !

Diferentes estilos

Diferentes necesidades

Diferentes series

UNA MISMA MARCA





DISEÑO FABRICACIÓN DISTRIBUCIÓN

Jandel presenta su nuevo catálogo ampliando su gama de productos, manivelas, manillones, pomos, tiradores y complementos de alta calidad, siguiendo las tendencias del mercado. El detalle es siempre importante y es ahí donde se aprecia la sensibilidad de quien crea, la manivela en una puerta nos permite abrirla, un gran compromiso y complicidad con la arquitectura es lo que la firma Jandel tiene desde sus inicios, una empresa dedicada al amplio sector de la ferretería y con una extensa experiencia.



CERTIFICADO DE CALIDAD ISO 9001-20158

ISO significa calidad, confianza, confianza, seguridad y muchos otros valores positivos para nuestros clientes. Es una norma de sistemas de gestión de la calidad. La norma más reconocida y establecida a nivel mundial de gestión de la calidad. En Jandel estamos orgullosos de formar parte de esta organización. Una metodología única que permite a gestionar a Jandel sus sistemas y sus riesgos de manera más eficiente para proteger sus futuros resultados. Ayuda a Jandel a cumplir con las expectativas y necesidades de sus clientes, entre otros beneficios. Las manillas, manillones, pomos, complementos para puertas y tiradores de Jandel están en buenas manos.



CUIDAMOS NUESTRO PLANETA

GESTIÓN DE RESIDUOS

La gestión de residuos, es la recolección, transporte, procesamiento o tratamiento, reciclaje o disposición de material de desecho, generalmente producida por la actividad humana, en un esfuerzo por reducir los efectos perjudiciales en la salud humana y la estética del entorno, aunque actualmente se trabaja no solo para reducir los efectos perjudiciales ocasionados al medio ambiente sino para recuperar a los recursos del mismo.

DESENGRASE DE METÁLES

Para las industrias en las que el proceso de producción incluye la fabricación o montaje de componentes metálicos, es fundamental un limpieza efectiva de grasas, aceites, taladrinas, desmoldeantes, etc. Nuestros artículos pasan por diferentes equipos para realizar esta operación, siempre con lavado de agua y productos biodegradables.



CUIDAMOS LOS DETALLES

EMBALAJE ECOLÓGICO

Conscientes de la problemática que representan los residuos en el medio ambiente, el packaging de nuestros artículos es respetuoso con el medio ambiente.

Jandel insiste en el uso de embalajes ecológicos para sus productos. Para conseguirlo, ha implementado el uso de materiales reciclados y reciclables, reducido el tamaño de las cajas de los productos y aumentando el uso de embalajes masivos.

JANDEL PREMIUM	
Manivelas	14
Bases.....	27
Grisanes	28
Manillones	29
Alzantes.....	32
Complementos	34

JANDEL ORIGINAL	
Manivelas	42
Bases.....	71
Manillones	72
Grisanes	80
Pomos de puerta	82
Complementos	86

JANDEL EQUAL	
Manivelas	94
Manillones	112
Complementos	122
Accesorios Técnicos.....	131

JANDEL INOX	
Manivelas	133
Manillones	138
Complementos	146
Pomos	149



































































JANDEL TIRADORES MUEBLE.....	150
------------------------------	-----

INDICE

JANDEL PREMIUM

 NEW 1301 14	 NEW 3310 19	 6318 25	 NEW C338 31	 38BY 36
 NEW 1311 14	 3327 19	 6328 25	 NEW 102AL2 32	 38BO 36
 1320 14	 3337 20	 6338 26	 NEW 359AL2 32	 38WC 36
 NEW 1327 15	 3357 21	 6347 26	 NEW 168AL2 33	 39BY 36
 1348 16	 3367 21	 BASES 27	 13BY 34	 39BO 36
 1356 16	 3377 21	 CG66 28	 13BO 34	 39WC 36
 1358 16	 3378 22	 CG20 28	 13WC 34	 63BY 37
 1366 17	 3388 23	 G88C 28	 NEW MARIONWC 34	 63BO 37
 NEW 1369 17	 3398 23	 C349 29	 33BY 35	 63WC 37
 NEW 1379 17	 3720 23	 EQ-M802 29	 33BO 35	 01WC 37
 1388 18	 3766 24	 C327 29	 33WC 35	 03WC 37
 1397 18	 3887 24	 NEW C379 30	 37BY 35	 CXBY 38
 1398 18	 NEW 3889 24	 NEW C369 30	 37BO 35	 CXBO 38
 NEW 1399 19	 3976 KUBO 25	 NEW C348 31	 37WC 35	 CXBYC 38

JANDEL ORIGINAL

				
CXBOC..... 38	1023..... 42	1224..... 45	KAROL..... 48	SV-R950..... 53
				
C630..... 39	1045..... 42	1229..... 45	EQ-R657..... 49	SV-C650..... 53
				
C635..... 39	1059..... 42	1234..... 45	EQ-R653..... 49	SV-C950..... 53
				
7610..... 39	1072..... 42	1239..... 45	EQ-R207..... 49	3012..... 54
				
7630..... 39	1075..... 42	1249..... 45	EQ-R208..... 49	3022..... 54
				
75220..... 40	1080..... 42	1254..... 45	EQ-R209..... 49	3070..... 54
				
75200..... 40	1082..... 43	12TE..... 46	EQ-R450..... 49	3080..... 54
				
75420..... 40	1090..... 43	15TE..... 46	EQ-R890..... 50	3082..... 54
				
75400..... 40	1092..... 43	WCTE..... 46	EQ-R891..... 50	3413..... 54
				
9510..... 41	1105..... 43	HQTE..... 46	EQ-R892..... 50	3424..... 55
				
9530..... 41	1115..... 44	H2TE..... 46	UOVO..... 52	3429..... 55
				
1209..... 44	1264..... 48	POLO PORCELANA..... 52	3434..... 55	
				
1213..... 44	2040..... 48	POLO..... 52	3449..... 55	
				
1219..... 44	6042..... 48	SV-R650..... 53	3570..... 57	

JANDEL ORIGINAL

 4513..... 57	 EQ-796..... 62	 PLACAS..... 71	 C327 76	 C209 85
 SV-PC65 57	 EQ-1599..... 62	 C302 72	 C322 77	 C605 86
 SVP650..... 57	 EQ-2733..... 63	 EQ-M890..... 72	 C326 77	 C606 86
 3223..... 58	 EQ-3800..... 63	 EQ-M891..... 72	 C359 79	 SV-BR25..... 86
 EQ-9690..... 58	 EQ-4402..... 64	 EQ-M892..... 72	 C800 79	 EQ-285Z 86
 EQ-9691..... 58	 EQ-4406..... 64	 C307 73	 CG75 80	 C608 87
 EQ-9692..... 58	 EQ-4419..... 65	 C308 73	 CGKA 80	 SV-CR50..... 87
 8045..... 59	 EQ-4423..... 66	 C309 73	 G13C 81	 C630 87
 1605..... 59	 EQ-4424..... 66	 C310 / C312... 73	 SV-105P..... 82	 12BY 87
 4459..... 59	 EQ-4450..... 67	 C311 74	 C207 82	 SV-495..... 88
 EQ-100B..... 60	 EQ-8300..... 67	 C313 74	 C208 82	 C611 89
 EQ-297..... 60	 EQ-9500..... 68	 C316 74	 EQ-1085..... 83	 34BY 89
 EQ-330..... 61	 EQ-9501..... 68	 C320 75	 EQ-1095..... 83	 C635 89
 EQ-525..... 61	 EQ-9600..... 69	 C349 75	 C210 84	 C902 89

JANDEL EQUAL



12WC 90



C621 90



34WC 90



SV-CC35 90



7610 91



7630 91



7510 91



7530 91



C410 92



C420 92



C450 92



C460 92



T490-91-92 93



A490-91-92 93



EQ-202 94



EQ-203 94



EQ-204 94



EQ-205 94



EQ-206 95



EQ-207 95



EQ-208 95



EQ-209 95



EQ-210 96



EQ-868 96



EQ-R204 99



EQ-R150 99



EQ-R200 99



EQ-R250 99



SV-R300 100



SV-R333 100



SV-R350 100



SV-R600 100



SV-R700 101



SV-R800 101



SV-R850 101



SV-R655 101



EQ-C150 102



EQ-C200 102



EQ-C350 102



EQ-C400 102



EQ-C700 102



EQ-C750 102



SV-P150 106



SV-P200 106



SV-P250 106



SV-P300 106



SV-P333 106



SV-P350 107



SV-P600 107



SV-P850 107



SV-P700 107



SV-PC20 108



SV-PC35 108



SV-PC70 108



SV-PC75 108



SV-P400 108



SV-P398 110



SV-P500 110



SV-PP50 110



SV-M500 110



SV-M150 112



SV-M350 112



SV-M200 112



SV-M335 113



EQ-M802 113



SV-M600 113



SV-MC15 114



SV-MC20 114



































































SV-MC35 114



SV-M400 114

JANDEL EQUAL



 EQ-M800..... 116	 SV-495 122	 SV-CCDC..... 125	 SV-A401..... 127	 BH-90RI..... 129
 EQ-M810..... 116	 EQ-1197..... 122	 SV-KITC 125	 PH-100D (DER.)... 128	 BI-90CD (DER.)... 129
 EQ-M831 116	 SV-BC15..... 123	 NEW KITC20 125	 PH-100I (IZQ.) ... 128	 BI-90CI 129
 NEW EQ-M861..... 116	 SV-BC25 123	 PICOLORO 125	 PH-95D (DER.) ... 128	 BI-80CD (DER.) .. 129
 SV-M360..... 119	 SV-B303..... 123	 SV-KITB 126	 PH-95I (IZQ.) 128	 BI-80CI 129
 NEW EQ-M802K..... 119	 SV-B308..... 123	 SV-KITC 126	 PI-100D (DER.) ... 128	 BI-90RD (DER.)... 129
 SV-MP15..... 120	 SV-CC35..... 123	 PU-47/PU-70... 126	 PI-100I (IZQ.)..... 128	 BI-90RD (IZQ.)... 129
 SV-PP15..... 120	 SV-CC50..... 123	 SV-PSMN..... 126	 PI-95D (DER.) 128	 NEW SV-PR..... 130
 SV-C150..... 120	 C902 123	 MR-2542 127	 PI-95I (IZQ.)..... 128	 NEW SV-PC..... 130
 EQ-285Z 122	 SVDEDALC 124	 MR-3560 127	 BH-90CD (DER.) . 129	ACCESORIOS TÉCNICOS 131
 SV-BR25..... 122	 SVDEDALR 124	 SV-TOPE 127	 BH-90CI..... 129	
 SV-B304..... 122	 SV-CCDR..... 124	 SV-T150..... 127	 BH-80CD (DER.) . 129	
 SV-B305..... 122	 SV-KITR 124	 SV-A150..... 127	 BH-80CI..... 129	
 SV-CR50..... 122	 KITR20 124	 SV-T401..... 127	 BH-90RD 129	

INDICE

JANDEL INOX

				
SV-R302..... 133	SV-X338..... 135	SV-M318..... 138	EQ-M810..... 144	SV-B303..... 147
				
SV-X302..... 133	SV-G338..... 135	SV-M338..... 138	EQ-M831..... 144	SV-B308..... 147
		 SV-M258..... 138		
SV-G302..... 133	SV-P338..... 135	SV-M258..... 138	EQ-M801..... 145	SV-B306..... 147
				
SV-F302..... 133	SV-P339..... 135	SV-M365..... 138	EQ-M802..... 145	SV-1198..... 147
				
SV-E302..... 133	SV-R318 / SV-R358... 136	SV-M360..... 138	EQ-M802K..... 145	HUELLA15..... 147
				
SV-P301..... 133	SV-P318..... 136	SV-MP32..... 139	SV-340..... 146	HUELLA20..... 147
				
SV-P302..... 133	SV-P319..... 136	SV-PP32..... 139	SV-345..... 146	TOPE INOX..... 147
				
SV-R336..... 134	SV-C334..... 136	SV-LP30..... 139	SV-348..... 146	SV-8510..... 148
				
SV-X336..... 134	SV-P334..... 136	SV-MF32..... 139	SV-B304..... 146	EQ-8610..... 148
	 SV-R258..... 137			
SV-G336..... 134	SV-R258..... 137	SV-LF30..... 139	SV-B305..... 146	SV-170P..... 149
	 SV-P258..... 137	 EQ-M861..... 140		
SV-F336..... 134	SV-P258..... 137	EQ-M861..... 140	SV-B307..... 146	SV-172P..... 149
	 SV-C413..... 137	 EQ-M851..... 142		
SV-P336..... 134	SV-C413..... 137	EQ-M851..... 142	SV-B309..... 146	
	 SV-P413..... 137	 EQ-M841..... 143		
SV-P337..... 134	SV-P413..... 137	EQ-M841..... 143	SV-346..... 147	
				
SV-R338..... 135	SV-M302..... 138	EQ-M800..... 144	SV-347..... 147	

JANDEL TIRADORES

			
M04..... 150	M24..... 152	H112 156	H132 159
			
M26..... 150	M25..... 152	H115 156	H133 159
			
M27..... 150	M26..... 152	H120 156	H134 159
			
M28..... 150	H55 154	H121 156	H135 159
			
M03..... 150	H76 154	H122 156	H136 160
			
M07..... 150	H93 154	H123 157	H137 160
			
M09..... 150	H94 154	H124 157	H138 160
			
M10..... 151	H95 154	H125 157	H140 160
			
M11..... 151	H102 154	H126 158	SV-HUELLA ... 160
			
M12..... 151	H103 154	H127 158	
			
M13..... 151	M113 154	M128 158	
			
M14..... 151	H107 155	H129 159	
			
M22..... 152	H108 155	H130 159	
			
M23..... 152	H111..... 155	H131 159	

LEYENDA DE ACABDOS.....161



NEW

1301 Plana ZK

Opciones	Ref.	ANTR	CB	CI	CS	NE	NM		
Ø50 5	1301							1	24
247 45	2301							1	12



NEW

1311 Cloe LAT

Opciones	Ref.	CB	CS	NE	PB		
Ø50 5	1311					1	16
247 45	2311					1	12



1320 Shape AL

Opciones	Ref.	ANTR	BL	CO.ST	EFCs	EFLM	NE	NM.OP		
Ø50 5	1320								1	24
247 45	2320								1	12



NEW

1327 Corsa ZK





Opciones	Ref.	ANTR	BL	CB	CS	NE	NM	NM.OP		
Ø50 5	1327								1	16
247 45	2327								1	12



- ANTR Antracita
- CI Cuero Inglés
- CS Cromo Satin. EFCS
- INOX
- NMM Níquel Mate Mate
- PB Pulido Brillo
- BL Blanco
- CO.ST Cobre Satin.
- Efect. Cromo Satin.
- LM Latón Mate
- NMOP Níquel Mat. Opaco
- PL Plata
- CB Cromo Brillo
- CU Cuero
- EFLM Efect. Latón Mate
- NM Níq. Mate
- NE Negro
- PL. AN Plata Anodizada







1348 Marina New ZK

Opciones	Ref.	CB	PL		
Ø50  5 	1348			1	16
247  45	2348			1	12







1356 Easy ZK

Opciones	Ref.	CB	CI	CS	NM		
Ø50  5 	1356					1	16
247  45	2356					1	12



1358 Altwien LAT

Opciones	Ref.	CB	PB		
Ø50  5 	1358			1	16
247  45	2358			1	12



1366 Olanda INOX

Opciones	Ref.	ANTR	BL	CB	EFLM	INOX	NE		
Ø50 5	1366							1	24
247 45	2366							1	12



NEW

1369 Marion LAT

Opciones	Ref.	CB	CI	LM	NE	NM	PB		
Ø50 5	1369							1	16
247 45	2369							1	12



NEW







1379 Inés LAT

Opciones	Ref.	BL	CB	CI	CS	LM	NE	NM	PB		
Ø50 5	1379									1	16
247 45	2379									1	12

- ANTR Antracita
- CI Cuero Inglés
- CS Cromo Satin. EFCS
- INOX
- NMM Níquel Mate Mate
- PB Pulido Brillo
- BL Blanco
- CO.ST Cobre Satin.
- Efect. Cromo Satin.
- LM Latón Mate
- NMOP Níquel Mat. Opaco
- PL Plata
- CB Cromo Brillo
- CU Cuero
- EFLM Efect. Latón Mate
- NM Níq. Mate
- NE Negro
- PL. AN Plata Anodizada









1388 Ice ZK

Opciones	Ref.	ANTR	BL	CB	CI	CS	NE	NM	NM.OP		
Ø50  5 	1388									1	16
247  45 	2388									1	12









1397 Adelle ZK

Opciones	Ref.	CB	CI	CS	NE	NM		
Ø50  5 	1397						1	16
247  45 	2397						1	12



1398 Slim ZK

Opciones	Ref.	ANTR	BL	CB	CS	NE	NM	NM.OP		
Ø50  5 	1398								1	16
247  45 	2398								1	12



NEW

1399 Punto ZK

Opciones	Ref.	ANTR	CB	CS	NE	NM		
Ø50 5	1399						1	16
247 45	2399						1	12



NEW

3310 Origami ZK

Opciones	Ref.	ANTR	BL	CB	CS	NE	NM		
50X50 5	3310							1	16
248 40	4310							1	12







3327 Corsa ZK

Opciones	Ref.	ANTR	BL	CB	CS	NE	NM	NM.OP		
50X50 5	3327								1	16
248 40	4327								1	12

- ANTR Antracita
- BL Blanco
- CB Cromo Brillo
- CI Cuero Inglés
- CO.ST Cobre Satin.
- CU Cuero
- CS Cromo Satin. EFCS
- Efect. Cromo Satin.
- EFLM Efect. Latón Mate
- INOX
- LM Latón Mate
- NM Níq. Mate
- NMM Níquel Mate Mate
- NMOP Níquel Mat. Opaco
- NE Negro
- PB Pulido Brillo
- PL Plata
- PL. AN Plata Anodizada



3337 Viper ZK

Opciones	Ref.	BL	CB	CI	CS	NE	NM		
50X50  5 	3337							1	16
248  40	4337							1	12





3357 Flake ZK

Opciones	Ref.	ANTR	CB	CI	NE	NM	NM.OP		
50X50 5	3357							1	16
248 40	4357							1	12

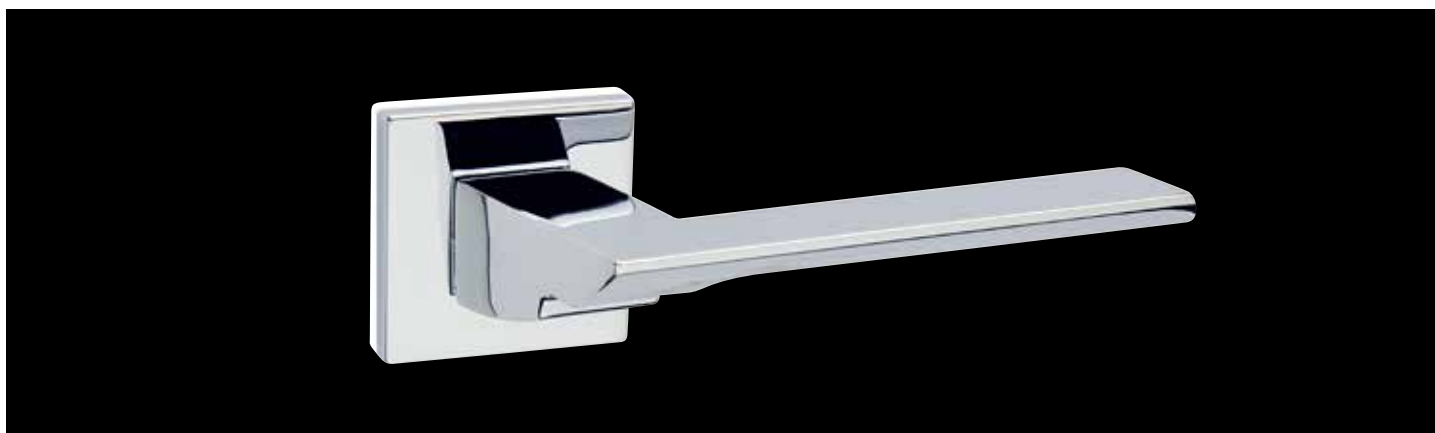

3367 Italia ZK

Opciones	Ref.	ANTR	BL	CB	CS	NE		
50X50 5	3367						1	16
248 40	4367						1	12







3377 Pura ZK

Opciones	Ref.	ANTR	BL	CB	CS	NE	NM.OP		
50X50 5	3377							1	16
248 40	4377							1	12

- ANTR Antracita
- BL Blanco
- CB Cromo Brillo
- CI Cuero Inglés
- CO.ST Cobre Satin.
- CU Cuero
- CS Cromo Satin. EFCS
- Efect. Cromo Satin.
- EFLM Efect. Latón Mate
- INOX
- LM Latón Mate
- NM Níq. Mate
- NMM Níquel Mate Mate
- NMOP Níquel Mat. Opaco
- NE Negro
- PB Pulido Brillo
- PL Plata
- PL.AN Plata Anodizada



3378 Swarovski LAT

Opciones	Ref.	CB		
50X50  5 	3378		1	16
248  40	4378		1	12

Con cristal de Swarovski





3388 Ice ZK

Opciones	Ref.	ANTR	BL	CB	CI	CS	NE	NM	NM.OP		
50x50 5	3388									1	16
248 40	4388									1	12



3398 Slim ZK

Opciones	Ref.	ANTR	BL	CB	CS	NE	NM	NMOP		
50x50 5	3398								1	16
248 40	4398								1	12









3720 Shape AL

Opciones	Ref.	ANTR	BL	CO.ST	EFCs	EFLM	NE	NM.OP		
Ø25 2	3720								1	24
247 45	2320								1	12

- ANTR Antracita
- BL Blanco
- CB Cromo Brillo
- CI Cuero Inglés
- CO.ST Cobre Satin.
- CU Cuero
- CS Cromo Satin. EFCs
- Efect. Cromo Satin.
- EFLM Efect. Latón Mate
- INOX
- LM Latón Mate
- NM Níq. Mate
- NMM Níquel Mate Mate
- NMOP Níquel Mat. Opaco
- NE Negro
- PB Pulido Brillo
- PL Plata
- PL. AN Plata Anodizada







3766 Olanda INOX

Opciones	Ref.	BL	CB	INOX	NE		
Ø25  2 	3766					1	24
247  45 	2366					1	12







3887 Infinity ZK

Opciones	Ref.	CS	NE		
52X35  10 	3887			1	16



NEW

3889 Futura AL

Opciones	Ref.	NE	PL.AN		
52X35  10 	3889			1	16



3976 Kubo AL

Opciones	Ref.	ANTR	BL	EFCS	NE	NM.OP		
25X25	3976						1	24
248	4376						1	12



6318 Juliette LAT

Opciones	Ref.	CI	PB	PL		
Ø50	6318				1	16
247	2318				1	12









6328 Vittoria LAT

Opciones	Ref.	CI	NE	PL		
Ø50	6328				1	16
247	2328				1	12

- ANTR Antracita
- CI Cuero Inglés
- CS Cromo Satin. EFCS
- INOX
- NMM Níquel Mate Mate
- PB Pulido Brillo
- BL Blanco
- CO.ST Cobre Satin.
- Efect. Cromo Satin.
- LM Latón Mate
- NMOP Níquel Mat. Opaco
- PL Plata
- CB Cromo Brillo
- CU Cuero
- EFLM Efect. Latón Mate
- NM Níq. Mate
- NE Negro
- PL. AN Plata Anodizada









6338 Rodi LAT

Opciones	Ref.	CB	PB		
Ø50  10 	6338			1	16
247  45 	2338			1	12



6347 Calliope ZK

Opciones	Ref.	CB	CI	CS	NM	PB	PL		
Ø50  10 	6347							1	16
247  45 	2347							1	12

Estas referencias se pueden montar con todas las manivelas y en todos los acabados de nuestra serie **Jandel Premium**

PLACAS

23 LAT

Placa manivela



43 LAT

Placa manivela



00 LAT

Placa manivela sin muelle



ROSETAS

CXC

60 x 30 x 10 mm
Roseta rect.
Con muelle



CX

60 x 30 x 10 mm
Roseta oval
Con muelle



GRISÁN

GC

64 x 30 x 10 mm
Placa grisán
DK rectangular



G

64 x 30 x 10 mm
Placa grisán
DK oval



Ref.	ANTR	BL	CB	CI	CO.ST	CS	EFCS	EFLM	INOX	LM	NE	NM	NM.OP	PB	PL
23															
43					-			-	-	-				-	-
00															
GC					-			-	-	-				-	-
G															
CXC					-			-	-	-				-	-
CX															

● ANTR Antracita
○ BL Blanco
● CB Cromo Brillo

● CI Cuero Inglés
● CO.ST Cobre Satin.
● CU Cuero

● CS Cromo Satin. EFCS
● Efect. Cromo Satin.
● EFLM Efect. Latón Mate

● INOX
● LM Latón Mate
● NM Níq. Mate

● NMM Níquel Mate Mate
● NMOP Níquel Mat. Opaco
● NE Negro

● PB Pulido Brillo
● PL Plata
● PL. AN Plata Anodizada



Ref.	BL	CB	INOX	NE	
CG66 INOX					



Ref.	ANTR	BL	CO.ST	EFC5	EFLM	NE	NM.OP	
CG20 AL								





Ref.	ANTR	BL	CB	CI	CS	NE	NM	NM.OP	
G88C ZK									



Ref.	mm (entre cent.)	BL	CB	INOX	NE	
EQ-M802 INOX	Ø25 (200)					2



Ref.	mm (entre cent.)	BL	CB	CO.ST	CS	EFLM	NE	NMM	
C349 ZK	200								2

Ref.	mm (entre cent.)	ANTR	BL	CB	CI	CO.ST	CS	EFLM	LM	NE	NM	NMM	PB	
C327 ZK	210													2

- ANTR Antracita
- CI Cuero Inglés
- CS Cromo Satin. EFCS
- INOX
- NMM Níquel Mate Mate
- PB Pulido Brillo
- BL Blanco
- CO.ST Cobre Satin.
- Efect. Cromo Satin.
- LM Latón Mate
- NMOP Níquel Mat. Opaco
- PL Plata
- CB Cromo Brillo
- CU Cuero
- EFLM Efect. Latón Mate
- NM Níq. Mate
- NE Negro
- PL. AN Plata Anodizada



NEW

Ref.	mm (entre cent.)	BL	CB	CI	CS	LM	NE	NM	PB	
C379 LAT	Ø20 (250)									2



NEW

Ref.	mm (entre cent.)	CB	CI	LM	NE	NM	PB	
C369 LAT	Ø22 (300)							



NEW

Ref.	mm (entre cent.)	CB	PL	
C348 ZK	210			



NEW

Ref.	mm (entre cent.)	CB	PB	
C338 LAT	265			

- ANTR Antracita
- CI Cuero Inglés
- CS Cromo Satin. EFCS
- INOX
- NMM Níquel Mate Mate
- PB Pulido Brillo
- BL Blanco
- CO.ST Cobre Satin.
- Efect. Cromo Satin.
- LM Latón Mate
- NMOP Níquel Mat. Opaco
- PL Plata
- CB Cromo Brillo
- CU Cuero
- EFLM Efect. Latón Mate
- NM Níq. Mate
- NE Negro
- PL. AN Plata Anodizada

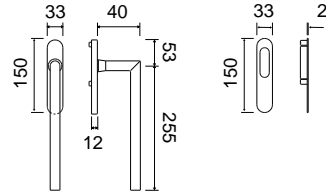

NEW

Ref.	ANTR	BL	INOX	NE	
102AL2 INOX					2

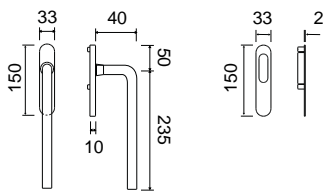

NEW

Ref.	CS	NE	PB	
359AL2 LAT				2

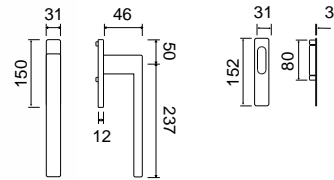
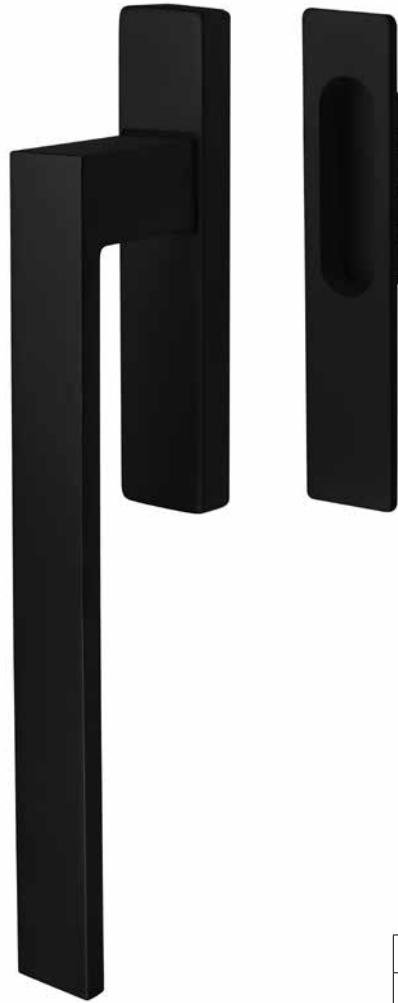

NEW

Ref.	ANTR	BL	CS	NE	
168AL2 ZK					2



-  ANTR Antracita
-  CI Cuero Inglés
-  CS Cromo Satin. EFCS
-  INOX
-  NMM Níquel Mate Mate
-  PB Pulido Brillo
-  BL Blanco
-  CO.ST Cobre Satin.
-  Efect. Cromo Satin.
-  LM Latón Mate
-  NMOP Níquel Mat. Opaco
-  PL Plata
-  CB Cromo Brillo
-  CU Cuero
-  EFLM Efect. Latón Mate
-  NM Níq. Mate
-  NE Negro
-  PL. AN Plata Anodizada

Serie 13 roseta Ø50x5 mm



Bocallaves ZK

Ref.	ANTR	BL	CB	CI	CO.ST	CS	EFCS	EFLM	INOX	LM	NE	NM	NM.OP	PB	PL	
13BY																10
13BO																10



Condenas ZK

Ref.	ANTR	BL	CB	CI	CO.ST	CS	EFCS	EFLM	INOX	LM	NE	NM	NM.OP	PB	PL	
13WC																5



NEW

Condenas LAT

Ref.	CB	CI	LM	NE	NM	PB	
MARIONWC							5

Serie 33 roseta 50x50x5 mm



Bocallaves ZK

Ref.	ANTR	BL	CB	CI	CS	NE	NM	NM.OP	
33BY									10
33BO									10



Condenas ZK

Ref.	ANTR	BL	CB	CI	CS	NE	NM	NM.OP	
33WC									5

Serie 37 roseta Ø25x2 mm



Bocallaves ZK

Ref.	mm	ANTR	BL	CB	CO.ST	EFCS	EFLM	NE	NM.OP	
37BY	40x25x2									10
37BO	25x2									10



Condenas LAT

Ref.	ANTR	BL	CB	CO.ST	EFCS	EFLM	INOX	NE	NM.OP	
37WC										5

- ANTR Antracita
- BL Blanco
- CB Cromo Brillo
- CI Cuero Inglés
- CO.ST Cobre Satin.
- CU Cuero
- CS Cromo Satin. EFCS
- Efect. Cromo Satin.
- EFLM Efect. Latón Mate
- INOX
- LM Latón Mate
- NM Níq. Mate
- NMM Níquel Mate Mate
- NMOP Níquel Mat. Opaco
- NE Negro
- PB Pulido Brillo
- PL Plata
- PL. AN Plata Anodizada

Serie 38 roseta 52x40x10 mm



Bocallaves ZK

Ref.	CS	NE	
38BY			10
38BO			10



Condenas LAT

Ref.	CS	NE	
38WC			5

Serie 39 roseta 25x25x2 mm



Bocallaves ZK

Ref.	mm	ANTR	BL	EFCS	NE	NM.OP	
39BY	40x25x2						10
39BO	25x25x2						10



Condenas LAT

Ref.	ANTR	BL	EFCS	NE	NM.OP	
39WC						5

Serie 63 roseta Ø50x10 mm



Bocallaves LAT

Ref.	CB	CI	CS	NE	NM	PB	PL	
63BY								10
63BO								10



Condenas LAT

Ref.	CB	CI	CS	NE	NM	PB	PL	
63WC								5

Roseta 35 mm



Condenas roseta Ø35x7 mm LAT

Ref.	ANTR	BL	CB	CI	CO.ST	CS	EFCS	EFLM	LM	NE	NM	NM.OP	PB	PL	
01WC															5



Condenas roseta 35x35x7 mm LAT

Ref.	ANTR	BL	CB	CI	CS	NE	NM	NM.OP	
03WC									5

- ANTR Antracita
- CI Cuero Inglés
- CS Cromo Satin. EFCS
- INOX
- NMM Níquel Mate Mate
- PB Pulido Brillo
- BL Blanco
- CO.ST Cobre Satin.
- Efect. Cromo Satin.
- LM Latón Mate
- NMOP Níquel Mat. Opaco
- PL Plata
- CB Cromo Brillo
- CU Cuero
- EFLM Efect. Latón Mate
- NM Níq. Mate
- NE Negro
- PL. AN Plata Anodizada

Roseta oval 60x30x10 mm

NEW



CXBY ZK

Ref.	ANTR	BL	CB	CI	CO.ST	CS	EFCS	EFLM	NE	NM	NM.OP	PB	PL	
CXBY														10

NEW



CXBO ZK

Ref.	ANTR	BL	CB	CI	CO.ST	CS	EFCS	EFLM	NE	NM	NM.OP	PB	PL	
CXBO														10

Roseta rectangular 60x30x10 mm

NEW



CXBYC ZK

Ref.	ANTR	BL	CB	CI	CO.ST	CS	EFCS	EFLM	NE	NM	NM.OP	PB	PL	
CXBYC														10

NEW



CXBOC ZK

Ref.	ANTR	BL	CB	CI	CO.ST	CS	EFCS	EFLM	NE	NM	NM.OP	PB	PL	
CXBOC														10

Bocallaves de seguridad (puerta de entrada)



C630 roseta Ø50x10 mm (seguridad) LAT

Ref.	ANTR	BL	CB	CI	CS	LM	NE	NM	NMM	PB	PL	
C630												10



C635 roseta 50x50x10 mm (seguridad) LAT

Ref.	ANTR	BL	CB	CI	CS	LM	NE	NM	NMM	PB	PL	
C635												10



Kit redondo Ø56 mm (Ø48 interior) LAT

Ref.	ANTR	BL	CB	CI	CO.ST	CS	EFLM	LM	NE	NM	NM.OP	PB	PL	
7610														1



Kit cuadrado 56x56 mm (Ø48 interior) LAT

Ref.	ANTR	BL	CB	CI	CS	LM	NE	NM	NM.OP	PB	
7630											1

- ANTR Antracita
- BL Blanco
- CB Cromo Brillo
- CI Cuero Inglés
- CO.ST Cobre Satin.
- CU Cuero
- CS Cromo Satin. EFCS
- Efect. Cromo Satin.
- EFLM Efect. Latón Mate
- INOX
- LM Latón Mate
- NM Níq. Mate
- NMM Níquel Mate Mate
- NMOP Níquel Mat. Opaco
- NE Negro
- PB Pulido Brillo
- PL Plata
- PL. AN Plata Anodizada

Ref. 75220 LAT

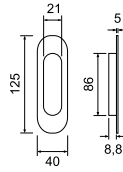

Ref. 75200 LAT

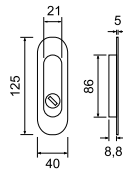



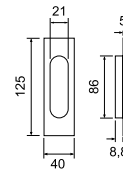

Ref. 75420 LAT

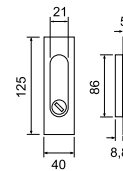

Ref. 75400 LAT



Opciones	Ref.	ANTR	BL	CB	CI	CS	CU	LM	NE	NM	NM.OP	PB	
125-40 	7.5220												
125-40 	7.5200												
125-40 	7.5420												
125-40 	7.5400												

Kits correderas



Kit redondo c/condena Ø56 mm (Ø48 interior) ZK

Ref.	BL	CB	CS	CU	LM	NE	NM	PB	
9510									1



Kit cuadrado c/condena 56x56 mm (Ø48 interior) ZK

Ref.	BL	CB	CS	LM	NE	NM	PB	
9530								1

- ANTR Antracita
- BL Blanco
- CB Cromo Brillo
- CI Cuero Inglés
- CO.ST Cobre Satin.
- CU Cuero
- CS Cromo Satin. EFCS
- Efect. Cromo Satin.
- EFLM Efect. Latón Mate
- INOX
- LM Latón Mate
- NM Níq. Mate
- NMM Níquel Mate Mate
- NMOP Níquel Mat. Opaco
- NE Negro
- PB Pulido Brillo
- PL Plata
- PL. AN Plata Anodizada



1023 Gótica LAT

Opciones	Ref.	CI	PL		
Ø50 10	1023			1	20
280 50	8023			1	20



1045 Flexa LAT

Opciones	Ref.	CI	CS	LM	NM	PB		
Ø50 10	1045						1	25
241 42	1545						1	20

JANDEL ORIGINAL



1059 Air ZK

Opciones	Ref.	AN	CI	NE	PL		
Ø50 10	1059					1	20
265 48	4459					1	20



1072 Nuri LAT

Opciones	Ref.	CI	CS	LM	NM	PB		
Ø50 10	1072						1	25
241 42	1572						1	20



1075 Corinne LAT

Opciones	Ref.	CI	CU	LM	MR	NM	PB	PL		
Ø50 10	1075								1	25
241 42	1575								1	20









1080 Pilar LAT

Opciones	Ref.	CC	CI	CS	LM	NM	PB		
Ø50 10	1080							1	20
241 42	1580							1	20









1082 Kubic LAT

Opciones	Ref.	CC	CS	LM	NM	PB		
Ø50  10 	1082						1	20
241  42 	1582						1	20









1105 Gaudel LAT

Opciones	Ref.	CI	CS	LM	NM	PB		
Ø50  10 	1105						1	25
241  42 	1605						1	20









1090 Marina LAT

Opciones	Ref.	CS	LM	NM		
Ø50  10 	1090				1	25
241  42 	1590				1	20



1092 Teka ZK

Opciones	Ref.	CS	NM		
Ø50  10 	1092			1	25
241  42 	1592			1	20



- AN Anticato
- CB Cromo Brillo
- CS Cromo Satinado
- MR Marrón
- NMM Níquel Mate Mate
- PB Pulido Brillo
- PVLML PVD Lat. Mate
- ANTR Antracita
- CC Cromo Combinado
- CU Cuero
- NE Negro
- NM.OP Níq. Mat. Opaco
- PS Pulido Satin.
- BL Blanco
- CI Cuero Inglés
- LM Latón Mate
- NM Níquel Mate
- NS Níquel Satinado
- PL Plata

JANDEL ORIGINAL



1115 Venere LAT

Opciones	Ref.	CB	CI	CS	LM	NM		
Ø50 10	1115						1	20
241 42	1615						1	20

1209 Eva ZK

Opciones	Ref.	ANTR	CB	CS	NE	PVLM		
Ø50 10	1209						1	20
241 42	1509						1	20

JANDEL ORIGINAL



1213 Elle ZK

Opc.	Ref.	ANTR	BL	CB	CI	CS	LM	NE	NM	PVLM		
Ø50 10	1213										1	20
241 42	1513										1	20

1219 Laia ZK

Opciones	Ref.	CB	CS	NE	NM		
Ø50 10	1219					1	20
241 42	1519					1	20





1224 Juan ZK

Opciones	Ref.	CB	CS	NM		
Ø50 10	1224				1	20
241 42	1524				1	20



1229 Dolce ZK

Opciones	Ref.	CB	CS	NE	NMM		
Ø50 10	1229					1	20
241 42	1529					1	20



1234 Virgo ZK

Opciones	Ref.	CB	CS	NE	NM		
Ø50 10	1234					1	20
241 42	1534					1	20



1239 Susi ZK

Opciones	Ref.	CB	CS	NE	NMM		
Ø50 10	1239					1	20
241 50	1539					1	20



1249 Clubb ZK

Opciones	Ref.	ANTR	BL	CB	CI	CS	NE	NMM		
50 10	1249								1	20
241 42	1549								1	20



1254 Aria ZK

Opciones	Ref.	CB	CS	NM		
Ø50 10	1254				1	20
241 42	1554				1	20

- AN Anticato
- CB Cromo Brillo
- CS Cromo Satinado
- MR Marrón
- NMM Níquel Mate Mate
- PB Pulido Brillo
- PVLM PVD Lat. Mate
- ANTR Antracita
- CC Cromo Combinado
- CU Cuero
- NE Negro
- NM.OP Niq. Mat. Opaco
- PS Pulido Satin.
- BL Blanco
- CI Cuero Inglés
- LM Latón Mate
- NM Níquel Mate
- NS Níquel Satinado
- PL Plata

JANDEL ORIGINAL



NEW

12TE ZK

Opciones	Ref.	BL	CI	LM	NE	NM		
	12TE						1	20
	15TE						1	20
	WCTE						2	40
	HQTE						10	200
	H2TE						5	100

















- | | | | | | | |
|------------------|----------------------|---------------------|------------------|-------------------------|--------------------|----------------------|
| ● AN Anticato | ● CB Cromo Brillo | ● CS Cromo Satinado | ● MR Marrón | ● NMM Níquel Mate Mate | ● PB Pulido Brillo | ● PVLM PVD Lat. Mate |
| ● ANTR Antracita | ● CC Cromo Combinado | ● CU Cuero | ● NE Negro | ● NM.OP Níq. Mat. Opaco | ● PS Pulido Satin. | |
| ○ BL Blanco | ● CI Cuero Inglés | ● LM Latón Mate | ● NM Níquel Mate | ● NS Níquel Satinado | ● PL Plata | |



1264 Heavy ZK

Opciones	Ref.	CB	CS	NM		
Ø50  10 	1264				1	20
241  42 	1564				1	20







2040 Línea LAT

Opciones	Ref.	CS	LM	NM		
Ø50  10 	2040				1	25
241  42 	2540				1	20







JANDEL ORIGINAL



6042 Polaris LAT

Opciones	Ref.	CC	CI	CS	CU	LM	NM	PB	PS		
Ø50  10 	6042									1	25
241  42 	1542									1	20

Karol ZK

Opciones	Ref.	CI	LM	NM	PB		
Ø50  10 	KAROL ROSETA					1	25
241  42 	KAROL PLACA					1	20





EQ-R207 ZK

Opciones	PB		
Ø50 10		1	20



EQ-R208 ZK

Opciones	CU		
Ø50 10		1	20



EQ-R209 ZK

Opciones	NM		
Ø50 10		1	20



EQ-R450 LAT

Opciones	CU	PB		
Ø50 10			1	20



NEW Tapa Pomos

EQ-R653 ZK

mm	CS	NE	NM		
Ø 65				1	20



NEW Tapa Pomos





EQ-R657 ZK

mm	CU	NE	NM	PB		
Ø 65					1	20

- AN Anticato
- CB Cromo Brillo
- CS Cromo Satinado
- MR Marrón
- NMM Níquel Mate Mate
- PB Pulido Brillo
- PVLML PVD Lat. Mate
- ANTR Antracita
- CC Cromo Combinado
- CU Cuero
- NE Negro
- NM.OP Níq. Mat. Opaco
- PS Pulido Satin.
- BL Blanco
- CI Cuero Inglés
- LM Latón Mate
- NM Níquel Mate
- NS Níquel Satinado
- PL Plata







EQ-R890 LAT

Opciones	AN	CI	CU	NM	PB	PL		
Ø50  10 							1	20

*Porcelana craquelé







EQ-R891 LAT

Opciones	AN	CI	CU	NM	PB	PL		
Ø50  10 							1	20

*Porcelana beige



EQ-R892 LAT

Opciones	AN	CI	CU	NM	PB	PL		
Ø50  10 							1	20

*Porcelana blanca









JANDEL ORIGINAL

- | | | | | | | |
|------------------|----------------------|---------------------|------------------|-------------------------|--------------------|-----------------------|
| ● AN Anticato | ● CB Cromo Brillo | ● CS Cromo Satinado | ● MR Marrón | ● NMM Níquel Mate Mate | ● PB Pulido Brillo | ● PVL M PVD Lat. Mate |
| ● ANTR Antracita | ● CC Cromo Combinado | ● CU Cuero | ● NE Negro | ● NM.OP Níq. Mat. Opaco | ● PS Pulido Satin. | |
| ○ BL Blanco | ● CI Cuero Inglés | ● LM Latón Mate | ● NM Níquel Mate | ● NS Níquel Satinado | ● PL Plata | |







Uovo LAT





Opciones	Ref.	CB	CI	CS	CU	LM	NM	PB		
Ø50  10 	UOVO ROSETA								1	25
241 	UOVO PLACA								1	20



Polo (PORCELANA) LAT

Opciones	Ref.	CI	NM	PB		
Ø50  10 	POLO PORC. ROSETA				1	25
241 	POLO PORC. PLACA				1	20





Polo LAT

Opciones	Ref.	CB	CI	CS	CU	LM	NM	PB		
Ø50  10 	POLO ROSETA								1	25
241 	POLO PLACA								1	20









SV-R650 ZK

Opciones	CB	CS	NM		
Ø50  10 				1	20







SV-C650 ZK

Opciones	CB	CS	NM		
50x50  10 				1	20







SV-R950 ZK

Opciones	NM		
Ø50  10 		1	20



















SV-C950 ZK

Opciones	NM		
50x50  10 		1	20

JANDEL ORIGINAL



-  AN Anticato
-  ANTR Antracita
-  BL Blanco
-  CB Cromo Brillo
-  CC Cromo Combinado
-  CI Cuero Inglés
-  CS Cromo Satinado
-  CU Cuero
-  LM Latón Mate
-  MR Marrón
-  NE Negro
-  NM Níquel Mate
-  NMM Níquel Mate Mate
-  NM.OP Níq. Mat. Opaco
-  NS Níquel Satinado
-  PB Pulido Brillo
-  PS Pulido Satin.
-  PL Plata
-  PVL PVD Lat. Mate

Manivelas



3012 Laura LAT

Opciones	Ref.	CB	CC	CS	NM		
50X50 10	3012					1	20
269 55	3512					1	20
241 42	4512					1	20

3022 Natalia LAT

Opciones	Ref.	CB	CC	CS	NM		
50X50 10	3022					1	20
269 55	3522					1	20
241 42	4522					1	20



3070 Iber LAT

Opciones	Ref.	CC	CI	CS	NM		
50X50 10	3070					1	20
269 55	3570					1	20
241 42	4570					1	20

3080 Pilar LAT

Opciones	Ref.	CC	CI	CS	LM	NM	PB		
50X50 10	3080							1	20
269 55	3580							1	20
241 42	4580							1	20



3082 Kubic LAT

Opc.	Ref.	CB	CC	CS	LM	NM	PB		
50X50 10	3082							1	20
269 55	3582							1	20
241 42	4582							1	20

3413 Elle ZK

Opc.	Ref.	ANTR	BL	CB	CI	CS	LM	NE	NM	PVLM		
50X50 10	3413										1	20
269 55	3513	-	-							-	1	20
241 42	4513										1	20

JANDEL ORIGINAL



3424 Juan ZK

Opciones	Ref.	CB	CS	NM		
50X50 10	3424				1	20
269 55	3524				1	20
241 42	4524				1	20



3429 Dolce ZK

Opciones	Ref.	CB	CS	NE	NMM		
50X50 10	3429					1	20
269 55	3529				-	1	20
241 42	4529					1	20



3434 Virgo ZK

Opciones	Ref.	CB	CS	NE	NM		
50X50 10	3434					1	20
269 55	3534					1	20
241 42	4534					1	20



3449 Clubb ZK

Opciones	Ref.	BL	CB	CS	NE	NMM		
50X50 10	3449						1	20
269 55	3549	-				-	1	20
241 42	4549						1	20





- AN Anticato
- ANTR Antracita
- BL Blanco
- CB Cromo Brillo
- CC Cromo Combinado
- CI Cuero Inglés
- CS Cromo Satinado
- CU Cuero
- LM Latón Mate
- MR Marrón
- NE Negro
- NM Níquel Mate
- NMM Níquel Mate Mate
- NM.OP Níq. Mat. Opaco
- NS Níquel Satinado
- PB Pulido Brillo
- PS Pulido Satin.
- PL Plata
- PVLML PVD Lat. Mate

JANDEL ORIGINAL







3570 LAT

CC	CI	CS	NM		
				1	20



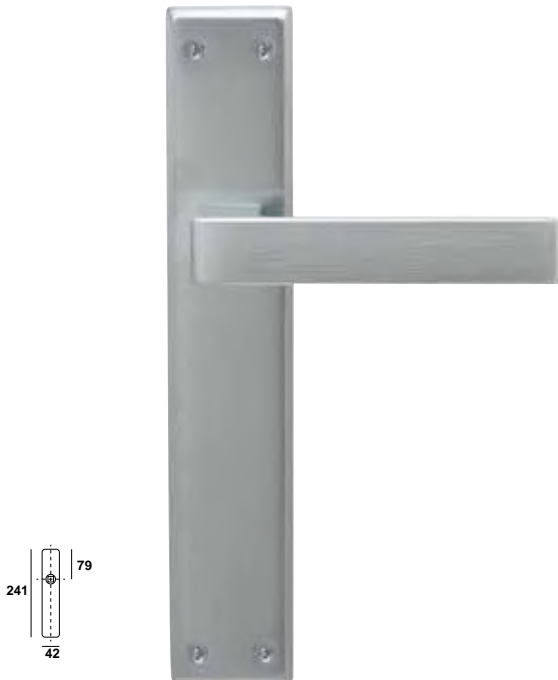

SV-PC65 ZK

CB	CS	NM		
			1	20





4513 LAT-ZK

ANTR	BL	CB	CC	CI	CS	LM	NE	NM	PVLM		
										1	20



SV-P650 ZK

CB	CS	NM		
			1	20

- AN Anticato
- ANTR Antracita
- BL Blanco
- CB Cromo Brillo
- CC Cromo Combinado
- CI Cuero Inglés
- CS Cromo Satinado
- CU Cuero
- LM Latón Mate
- MR Marrón
- NE Negro
- NM Níquel Mate
- NMM Níquel Mate Mate
- NM.OP Níq. Mat. Opaco
- NS Níquel Satinado
- PB Pulido Brillo
- PS Pulido Satin.
- PL Plata
- PVLM PVD Lat. Mate

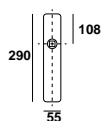

3223 LAT

CI	PB		
		1	20

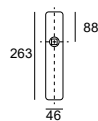

NEW

EQ-9690 LAT

CI		
	1	20

*Porcelana craquelé

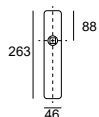

NEW

EQ-9691 LAT

CI		
	1	20

*Porcelana beige

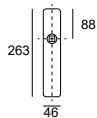

NEW

EQ-9692 LAT

CI		
	1	20

*Porcelana blanca



8045 LAT

CI	NM	PS		
			1	20



1605 LAT

CI	CS	LM	NM	PB		
					1	20



4459 LAT-ZK



AN	CI	NE	PL		
				1	20



JANDEL ORIGINAL

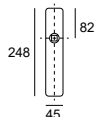

- AN Anticato
- CB Cromo Brillo
- CS Cromo Satinado
- MR Marrón
- NMM Níquel Mate Mate
- PB Pulido Brillo
- PVL M PVD Lat. Mate
- ANTR Antracita
- CC Cromo Combinado
- CU Cuero
- NE Negro
- NM.OP Níq. Mat. Opaco
- PS Pulido Satin.
- BL Blanco
- CI Cuero Inglés
- LM Latón Mate
- NM Níquel Mate
- NS Níquel Satinado
- PL Plata

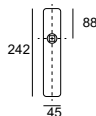

Ref.	Opciones	mm	PB		
EQ-100B	Jgo. Manivela	248x45		1	20
EQ-M100	Manillón	248x45		2	40
EQ-L100	Placa limpieza	248x45		10	100
EQ-C100	Asa corta c/placa	248x45		2	40
EQ-T203	Tirador armario	123x35		20	200
EQ-A203	Tirador maletero	83x35		20	200
EQ-P100	Placa pomo fijo	248x45		2	40
EQ-P100MV	Placa pomo móvil	248x45		2	40

LAT



Ref.	Opciones	mm	CU	PS		
EQ-297	Jgo. Manivela	242x45			1	20
EQ-M297	Manillón	242x45			2	40
EQ-L297	Placa limpieza	242x45			10	100
EQ-C297	Asa corta c/placa	242x45			2	40
EQ-T400	Tirador armario	123x35			20	200
EQ-A400	Tirador maletero	83x35			20	200
EQ-P297	Placa pomo fijo	242x45			2	40
EQ-P297MV	Placa pomo móvil	242x45			2	40

LAT

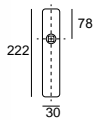

Ref.	Opciones	mm	CU	NM	PB		
EQ-330	Jgo. Manivela	222x30				1	20

LAT

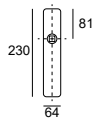



Ref.	Opciones	mm	CU	PS		
EQ-525	Jgo. Manivela	230x64			1	20
EQ-M525	Manillón	230x64			2	40
EQ-L525	Placa limpieza	230x64			10	100
EQ-C525	Asa corta c/placa	230x64			2	40
EQ-P525	Placa pomo fijo	230x64			2	40
EQ-P525MV	Placa pomo móvil	230x60			2	40

LAT

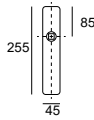

- AN Anticato
- CB Cromo Brillo
- CS Cromo Satinado
- MR Marrón
- NMM Níquel Mate Mate
- PB Pulido Brillo
- PVLML PVD Lat. Mate
- ANTR Antracita
- CC Cromo Combinado
- CU Cuero
- NE Negro
- NM.OP Níq. Mat. Opaco
- PS Pulido Satin.
- BL Blanco
- CI Cuero Inglés
- LM Latón Mate
- NM Níquel Mate
- NS Níquel Satinado
- PL Plata



Ref.	Opciones	mm	CU	PS		
EQ-796	Jgo. Manivela	255x45			1	20
EQ-M796	Manillón	255x45			2	40
EQ-L796	Placa limpieza	255x45			10	100
EQ-C796	Asa corta c/placa	255x45			2	40
EQ-T599	Tirador armario	129x33			20	200
EQ-A599	Tirador maletero	89x33			20	200
EQ-P796	Placa pomo fijo	255x45			2	40
EQ-P796MV	Placa pomo móvil	255x45			2	40

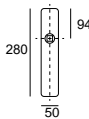

LAT



Ref.	Opciones	mm	CU	PS		
EQ-1599	Jgo. Manivela	280x50			1	20
EQ-M599	Manillón	280x50			2	40
EQ-L599	Placa limpieza	280x50			10	100
EQ-C599	Asa corta c/placa	280x50			2	40
EQ-T599	Tirador armario	128x33			20	200
EQ-A599	Tirador maletero	88x33			20	200
EQ-P599	Placa pomo fijo	280x50			2	40
EQ-P599MV	Placa pomo móvil	280x50			2	40

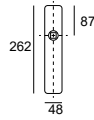

LAT

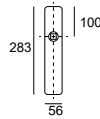

Ref.	Opciones	mm	CU	PS		
EQ-2733	Jgo. Manivela	262x48			1	20
EQ-M733	Manillón	262x48			2	40
EQ-L733	Placa limpieza	262x48			10	100
EQ-C733	Asa corta c/placa	262x48			2	40
EQ-T400	Tirador armario	128x33			20	200
EQ-A400	Tirador maletero	88x33			20	200
EQ-P733	Placa pomo fijo	262x48			2	40
EQ-P733MV	Placa pomo móvil	262x48			2	40

LAT





Ref.	Opciones	mm	NM	PS		
EQ-3800	Jgo. Manivela	283X56			1	20
EQ-M380	Manillón	283X56			2	40
EQ-L800	Placa limpieza	283X56			10	100
EQ-C800	Asa corta c/placa	283X56			2	40
EQ-T400	Tirador armario	128x33			20	200
EQ-A400	Tirador maletero	88x33			20	200
EQ-P800	Placa pomo fijo	283X56			2	40
EQ-P800MV	Placa pomo móvil	283x56			2	40

LAT

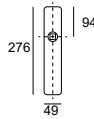

- AN Anticato
- ANTR Antracita
- BL Blanco
- CB Cromo Brillo
- CC Cromo Combinado
- CI Cuero Inglés
- CS Cromo Satinado
- CU Cuero
- LM Latón Mate
- MR Marrón
- NE Negro
- NM Níquel Mate
- NMM Níquel Mate Mate
- NM.OP Níq. Mat. Opaco
- NS Níquel Satinado
- PB Pulido Brillo
- PS Pulido Satin.
- PL Plata
- PVLML PVD Lat. Mate

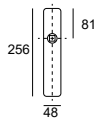

Ref.	Opciones	mm	CU	PS		
EQ-4402	Jgo. Manivela	276x49			1	20
EQ-M402	Manillón	276x49			2	40
EQ-L402	Placa limpieza	276x49			10	100
EQ-C402	Asa corta c/placa	276x49			2	40
EQ-T599	Tirador armario	128x33			20	200
EQ-A599	Tirador maletero	88x33			20	200
EQ-P402	Placa pomo fijo	276x49			2	40
EQ-P402MV	Placa pomo móvil	276x49			2	40

LAT



Ref.	Opciones	mm	CU	PS		
EQ-4406	Jgo. Manivela	256x48			1	20
EQ-M406	Manillón	256x48			2	40
EQ-L406	Placa limpieza	256x48			10	100
EQ-C406	Asa corta c/placa	256x48			2	40
EQ-T400	Tirador armario	128x33			20	200
EQ-A400	Tirador maletero	88x33			20	200
EQ-P406	Placa pomo fijo	256x48			2	40
EQ-P406MV	Placa pomo móvil	256x48			2	40

LAT

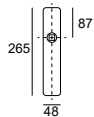

Ref.	Opciones	mm	CU	NM	PS		
EQ-4419	Jgo. Manivela	265x48				1	20
EQ-M419	Manillón	265x48				2	40
EQ-L419	Placa limpieza	265x48				10	100
EQ-C419	Asa corta c/placa	265x48				2	40
EQ-T400	Tirador armario	128x33				20	200
EQ-A400	Tirador maletero	88x33				20	200
EQ-P419	Placa pomo fijo	265x48				2	40
EQ-P419MV	Placa pomo móvil	265x48				2	40



LAT

JANDEL ORIGINAL



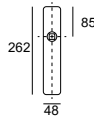

- AN Anticato
- CB Cromo Brillo
- CS Cromo Satinado
- MR Marrón
- NMM Níquel Mate Mate
- PB Pulido Brillo
- PVLML PVD Lat. Mate
- ANTR Antracita
- CC Cromo Combinado
- CU Cuero
- NE Negro
- NM.OP Níq. Mat. Opaco
- PS Pulido Satin.
- BL Blanco
- CI Cuero Inglés
- LM Latón Mate
- NM Níquel Mate
- NS Níquel Satinado
- PL Plata



Ref.	Opciones	mm	CU	PS		
EQ-4423	Jgo. Manivela	262x48			1	20
EQ-M423	Manillón	262x48			2	40
EQ-L423	Placa limpieza	262x48			10	100
EQ-C423	Asa corta c/placa	262x48			2	40
EQ-T424	Tirador armario	131x35			20	200
EQ-A424	Tirador maletero	85x35			20	200
EQ-P423	Placa pomo fijo	262x48			2	40
EQ-P423MV	Placa pomo móvil	262x48			2	40

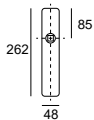

LAT



Ref.	Opciones	mm	CU	PS		
EQ-4424	Jgo. Manivela	262x48			1	20
EQ-M424	Manillón	262x48			2	40
EQ-L424	Placa limpieza	262x48			10	100
EQ-C424	Asa corta c/placa	262x48			2	40
EQ-T424	Tirador armario	131x35			20	200
EQ-A424	Tirador maletero	85x35			20	200
EQ-P424	Placa pomo fijo	262x48			2	40
EQ-P424MV	Placa pomo móvil	262x48			2	40

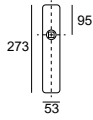

LAT

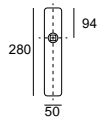

Ref.	Opciones	mm	CU	PS		
EQ-4450	Jgo. Manivela	273X53			1	20
EQ-M450	Manillón	273X53			2	40
EQ-L450	Placa limpieza	273X53			10	100
EQ-C450	Asa corta c/placa	273X53			2	40
EQ-T400	Tirador armario	128x33			20	200
EQ-A400	Tirador maletero	88x33			20	200
EQ-P450	Placa pomo fijo	273X53			2	40
EQ-P450MV	Placa pomo móvil	273x53			2	40

LAT





Ref.	Opciones	mm	CU	PS		
EQ-8300	Jgo. Manivela	280x50			1	20
EQ-M300	Manillón	280x50			2	40
EQ-L300	Placa limpieza	280x50			10	100
EQ-C300	Asa corta c/placa	280x50			2	40
EQ-T400	Tirador armario	128x33			20	200
EQ-A400	Tirador maletero	88x33			20	200
EQ-P300	Placa pomo fijo	280x50			2	40
EQ-P300MV	Placa pomo móvil	280x50			2	40

LAT

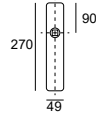

- AN Anticato
- ANTR Antracita
- BL Blanco
- CB Cromo Brillo
- CC Cromo Combinado
- CI Cuero Inglés
- CS Cromo Satinado
- CU Cuero
- LM Latón Mate
- MR Marrón
- NE Negro
- NM Níquel Mate
- NMM Níquel Mate Mate
- NM.OP Níq. Mat. Opaco
- NS Níquel Satinado
- PB Pulido Brillo
- PS Pulido Satin.
- PL Plata
- PVLML PVD Lat. Mate



Ref.	Opciones	mm	CU	PS		
EQ-9500	Jgo. Manivela	270x49			1	20
EQ-M500	Manillón	270x49			2	40
EQ-L500	Placa limpieza	270x49			10	100
EQ-C500	Asa corta c/placa	270x49			2	40
EQ-T400	Tirador armario	128x33			20	200
EQ-A400	Tirador maletero	88x33			20	200
EQ-P500	Placa pomo fijo	270x49			2	40
EQ-P500MV	Placa pomo móvil	270x49			2	40

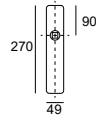

LAT



Ref.	Opciones	mm	CU	PS		
EQ-9501	Jgo. Manivela	270x49			1	20
EQ-M500	Manillón	270x49			2	40
EQ-L500	Placa limpieza	270x49			10	100
EQ-C500	Asa corta c/placa	270x49			2	40
EQ-T400	Tirador armario	128x33			20	200
EQ-A400	Tirador maletero	88x33			20	200
EQ-P500	Placa pomo fijo	270x49			2	40
EQ-P500MV	Placa pomo móvil	270x49			2	40

LAT



Ref.	Opciones	mm	CI	CU	PS		
EQ-9600	Jgo. Manivela	263x46				1	20
EQ-M600	Manillón	263x46				2	40
EQ-L600	Placa limpieza	263x46				10	100
EQ-C600	Asa corta c/placa	263x46				2	40
EQ-T400	Tirador armario	128x33				20	200
EQ-A400	Tirador maletero	88x33				20	200
EQ-P600	Placa pomo fijo	263x46				2	40
EQ-P600MV	Placa pomo móvil	263x46				2	40

LAT

JANDEL ORIGINAL



- AN Anticato
- CB Cromo Brillo
- CS Cromo Satinado
- MR Marrón
- NMM Níquel Mate Mate
- PB Pulido Brillo
- PVLM PVD Lat. Mate
- ANTR Antracita
- CC Cromo Combinado
- CU Cuero
- NE Negro
- NM.OP Níq. Mat. Opaco
- PS Pulido Satin.
- BL Blanco
- CI Cuero Inglés
- LM Latón Mate
- NM Níquel Mate
- NS Níquel Satinado
- PL Plata

JANDEL ORIGINAL



Estas referencias se pueden montar con todas las manivelas y en todos los acabados de nuestra serie **Jandel Original**

PLACAS LAT

35 Placa manivela



45 Placa manivela



15 Placa manivela



00 Placa manivela Sin muelle



ROSETAS ZK

CXC 64 x 30 mm Roseta rect. Con muelle



CX 64 x 30 mm Roseta oval Con muelle



GRISÁN ZK

GC 64 x 30 mm Placa grisán DK rectangular



G 64 x 30 mm Placa grisán DK oval



Ref.	AN	ANTR	BL	CB	CI	CS	CU	LM	MR	NE	NM	NMM	PB	PL	PVLM
35		-	-									-			-
45															
15															
00		-										-			-
GC		-										-			-
G		-										-			-
CXC		-										-			-
GX		-										-			-

- AN Anticato
- CB Cromo Brillo
- CS Cromo Satinado
- MR Marrón
- NMM Níquel Mate Mate
- PB Pulido Brillo
- PVLM PVD Lat. Mate
- ANTR Antracita
- CC Cromo Combinado
- CU Cuero
- NE Negro
- NM.OP Níq. Mat. Opaco
- PS Pulido Satin.
- BL Blanco
- CI Cuero Inglés
- LM Latón Mate
- NM Níquel Mate
- NS Níquel Satinado
- PL Plata

JANDEL ORIGINAL

Ref.	mm (centr.)	CB	CI	CS	CU	LM	NM	PB	
C302	150 (ROSETA)								5
C302	150 (PLACA)								2

Ref.	mm (centr.)	AN	CI	CU	NM	PB	PL	
EQ-M890	220							2

Porcelana craquelé

Ref.	mm (centr.)	AN	CI	CU	NM	PB	PL	
EQ-M891	220							2

Porcelana beige

Ref.	mm (centr.)	AN	CI	CU	NM	PB	PL	
EQ-M892	220							2

Porcelana blanca



C302 LAT

EQ-M890 LAT



EQ-M891 LAT



EQ-M892 LAT





Ref.	mm (entre cent.)	CB	CC	CI	CS	LM	NM	PB	
C307	200								2

Ref.	mm (entre cent.)	CB	CC	CI	CS	LM	NM	PB	
C308	200								2

Ref.	mm (entre cent.)	CB	CC	CI	CU	CS	LM	NM	PB	
C309	200									2

Ref.	mm (entre cent.)	AN	CB	CI	CS	CU	LM	MR	NE	NM	PB	PL	
C310	200												5
C312	160												10

C310 LAT
C312 LAT

JANDEL ORIGINAL

- AN Anticato
- ANTR Antracita
- BL Blanco
- CB Cromo Brillo
- CC Cromo Combinado
- CI Cuero Inglés
- CS Cromo Satinado
- CU Cuero
- LM Latón Mate
- MR Marrón
- NE Negro
- NM Níquel Mate
- NMM Níquel Mate Mate
- NM.OP Níq. Mat. Opaco
- NS Níquel Satinado
- PB Pulido Brillo
- PS Pulido Satin.
- PL Plata
- PVLML PVD Lat. Mate



C311 LAT





C313 LAT



C316 LAT

Ref.	mm (entre cent.)	AN	CB	CI	CS	CU	LM	MR	NM	PB	
C311	200										10

Ref.	mm (entre cent.)	CB	CI	CS	CU	LM	NM	PB	
C313	200								5

Ref.	mm (entre cent.)	CB	CC	CS	NM	
C316	200					2



C349 ZK



C320 LAT

Ref.	mm (entre cent.)	CB	CC	CS	NM	
C320	200					1
	250					1
	300					1
	400					1
	500					1

Ref.	mm (entre cent.)	ANTR	BL	CB	CS	NE	NMM	
C349	200							1

- AN Anticato
- ANTR Antracita
- BL Blanco
- CB Cromo Brillo
- CC Cromo Combinado
- CI Cuero Inglés
- CS Cromo Satinado
- CU Cuero
- LM Latón Mate
- MR Marrón
- NE Negro
- NM Níquel Mate
- NMM Níquel Mate Mate
- NM.OP Níq. Mat. Opaco
- NS Níquel Satinado
- PB Pulido Brillo
- PS Pulido Satin.
- PL Plata
- PVL M PVD Lat. Mate

JANDEL ORIGINAL



C327 ZK

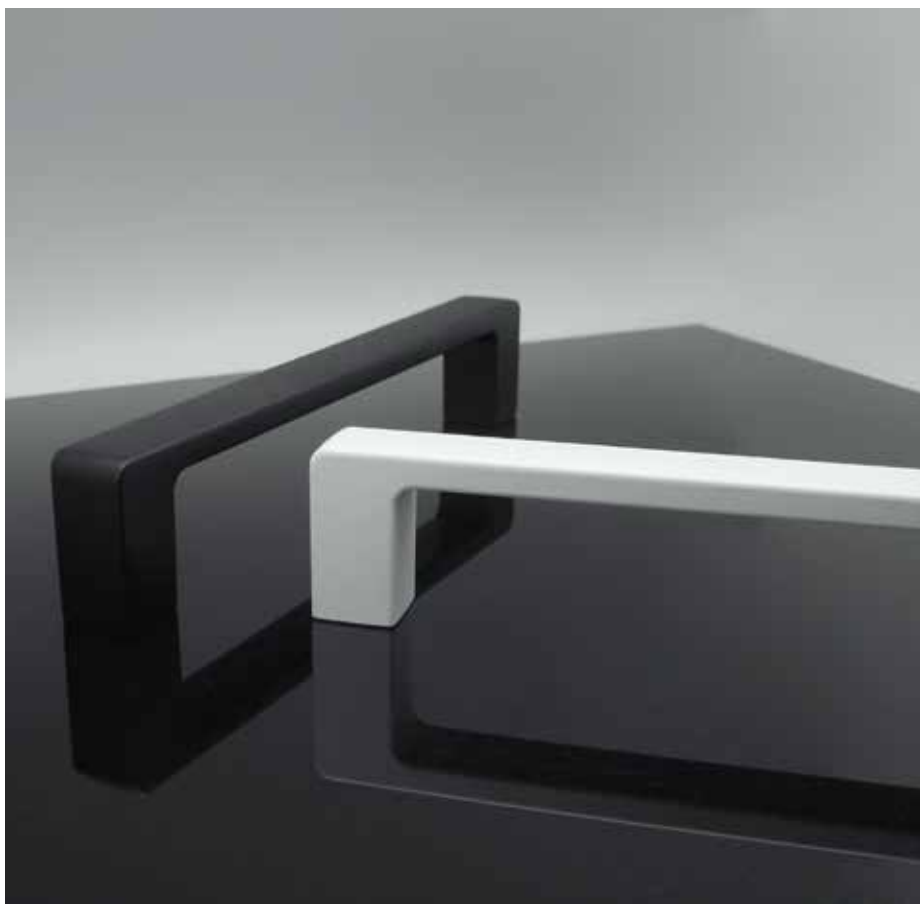

Ref.	mm (entre cent.)	ANTR	BL	CB	CI	CS	LM	NE	NMM	NS	PB	PVLM	
C327	210												2

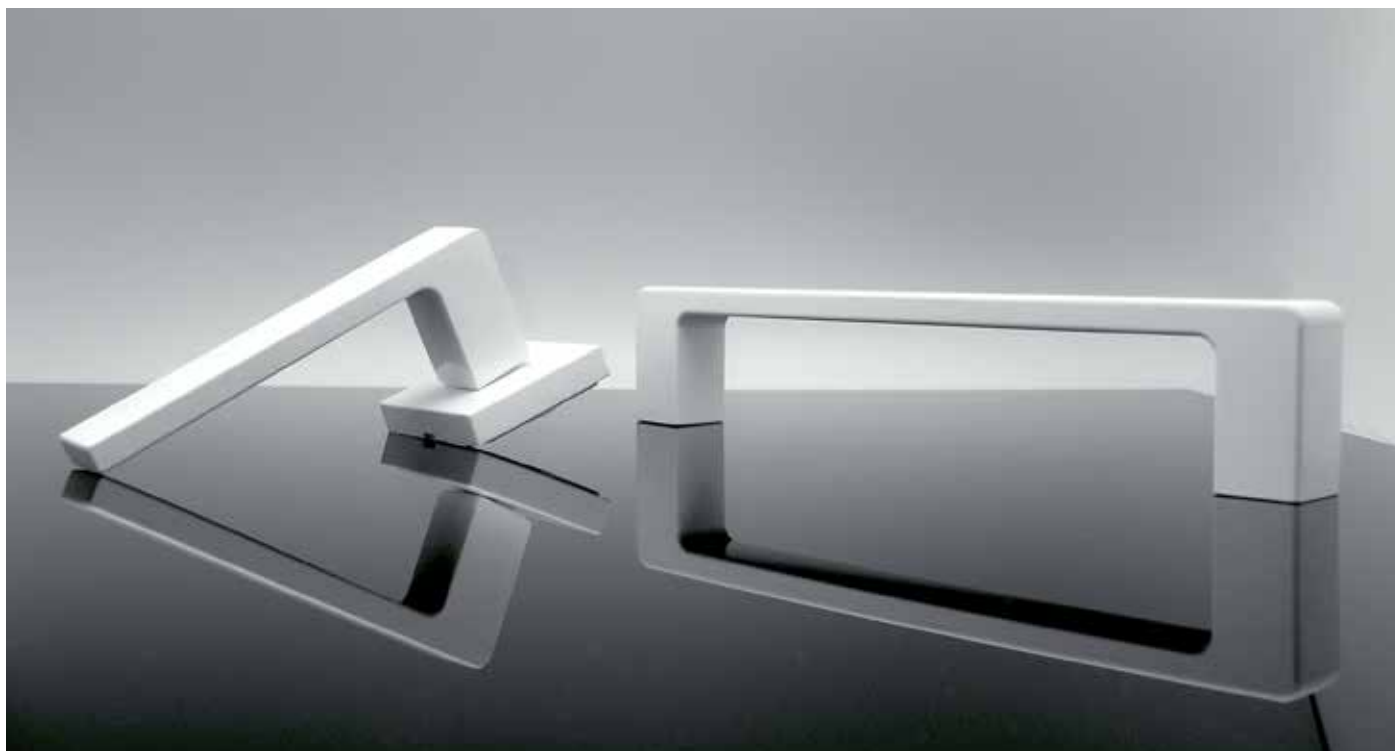



C322 ZK



C326 LAT

JANDEL ORIGINAL

Ref.	mm (entre cent.)	CI	CS	CU	LM	NM	PB	
C322	210							2

Ref.	mm (entre cent.)	CI	CU	LM	MR	NM	PB	PL	
C326	225								2

- AN Anticato
- ANTR Antracita
- BL Blanco
- CB Cromo Brillo
- CC Cromo Combinado
- CI Cuero Inglés
- CS Cromo Satinado
- CU Cuero
- LM Latón Mate
- MR Marrón
- NE Negro
- NM Níquel Mate
- NMM Níquel Mate Mate
- NM.OP Níq. Mat. Opaco
- NS Níquel Satinado
- PB Pulido Brillo
- PS Pulido Satin.
- PL Plata
- PVLML PVD Lat. Mate





C359 ZK

Ref.	mm (entre cent.)	AN	CI	NE	PL	
C359	220	21.89	21.89	21.89	21.89	2



C800 LAT

Ref.	mm (entre cent.)	CI	NM	PS	
C800	280x50	39.60	44.20	39.60	2

JANDEL ORIGINAL

- AN Anticato
- ANTR Antracita
- BL Blanco
- CB Cromo Brillo
- CC Cromo Combinado
- CI Cuero Inglés
- CS Cromo Satinado
- CU Cuero
- LM Latón Mate
- MR Marrón
- NE Negro
- NM Níquel Mate
- NMM Níquel Mate Mate
- NM.OP Níq. Mat. Opaco
- NS Níquel Satinado
- PB Pulido Brillo
- PS Pulido Satin.
- PL Plata
- PVL M PVD Lat. Mate



Ref.	CI	CU	LM	MR	NM	PB	PL	
CG75 LAT								2





















Ref.	CI	LM	NM	PB	
CGKA ZK					2



Ref.	CB	CS	NE	NM	
G13C ZK					2



-  AN Anticato
-  CB Cromo Brillo
-  CS Cromo Satinado
-  MR Marrón
-  NMM Níquel Mate Mate
-  PB Pulido Brillo
-  PVLM PVD Lat. Mate
-  ANTR Antracita
-  CC Cromo Combinado
-  CU Cuero
-  NE Negro
-  NM.OP Niq. Mat. Opaco
-  PS Pulido Satin.
-  BL Blanco
-  CI Cuero Inglés
-  LM Latón Mate
-  NM Níquel Mate
-  NS Níquel Satinado
-  PL Plata



Ref.	mm	PVD	
SV-105P	Ø85 (base)		1

ZK



Ref.	mm	CI	CU	LM	NM	PS	
C207	Ø90 (base)						1

LAT



Ref.	mm	CI	CU	PS	
C208	Ø85 (base)				1

LAT



Ref.	mm	BL	LM	NE	NS	PB	
EQ-1085	Ø85 (base)						1

LAT



Ref.	mm	CS	CU	NM	PB	
EQ-1095	Ø85 (base)					1

LAT

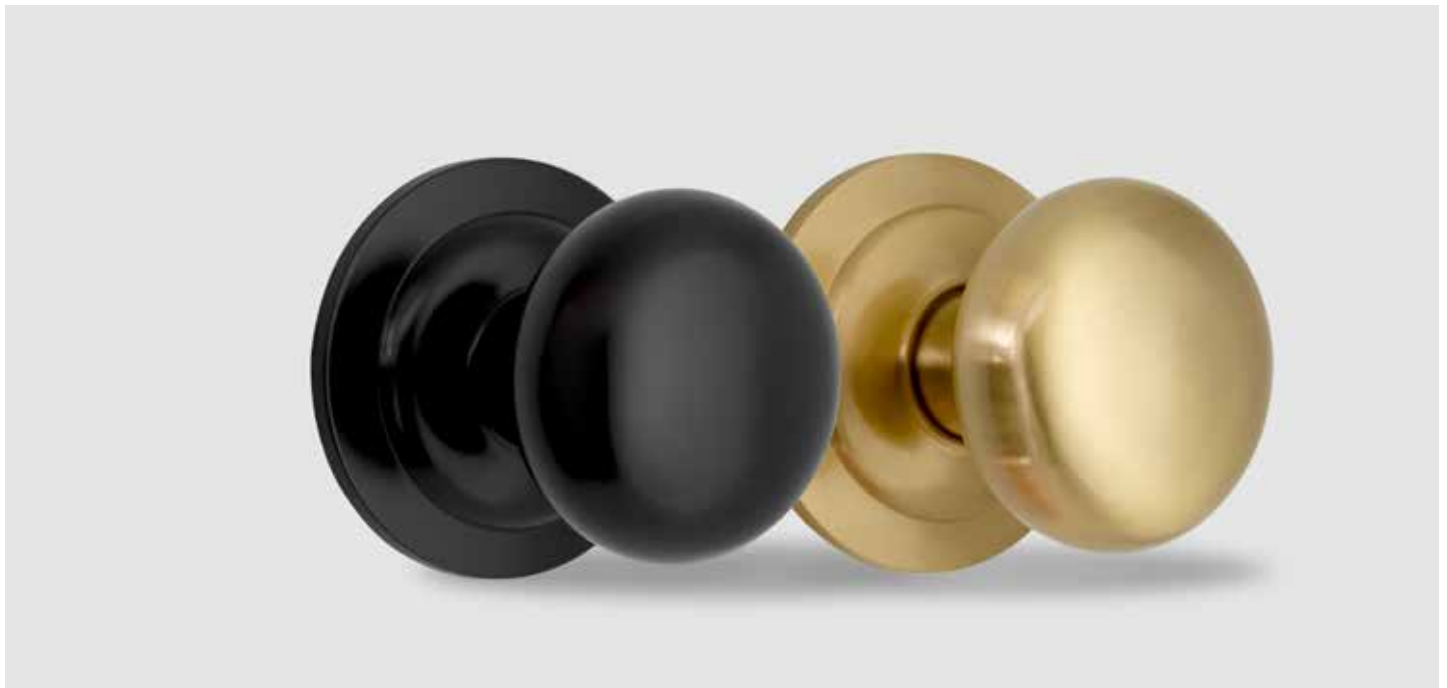

- AN Anticato
- CB Cromo Brillo
- CS Cromo Satinado
- MR Marrón
- NMM Níquel Mate Mate
- PB Pulido Brillo
- PVLML PVD Lat. Mate
- ANTR Antracita
- CC Cromo Combinado
- CU Cuero
- NE Negro
- NM.OP Níq. Mat. Opaco
- PS Pulido Satin.
- BL Blanco
- CI Cuero Inglés
- LM Latón Mate
- NM Níquel Mate
- NS Níquel Satinado
- PL Plata



Ref.	mm	CB	CS	LM	NE	NM	PB	
C210	Ø67 (Ø38 base)							1

LAT





Ref.	mm	CB	CI	CS	LM	NE	NM	PB	
C209	67x67 50x50 (base)								1

LAT



- AN Anticato
- ANTR Antracita
- BL Blanco
- CB Cromo Brillo
- CC Cromo Combinado
- CI Cuero Inglés
- CS Cromo Satinado
- CU Cuero
- LM Latón Mate
- MR Marrón
- NE Negro
- NM Níquel Mate
- NMM Níquel Mate Mate
- NM.OP Níq. Mat. Opaco
- NS Níquel Satinado
- PB Pulido Brillo
- PS Pulido Satin.
- PL Plata
- PVL M PVD Lat. Mate



Ref.	mm	ANT	CC	CI	CS	CU	LM	MR	PL	
C605	Ø50									10

LAT



Ref.	mm	ANT	CC	CI	CS	CU	LM	MR	PL	
C606	Ø50									10

LAT



Ref.	mm	AN	CB	CI	CS	CU	LM	MR	NS	PB	PL	
SV-BR25	Ø50											10

ZK



Ref.	mm	AN	CB	CI	CS	CU	LM	MR	NS	PB	PL	
EQ-285Z	Ø50											10

ZK



Ref.	mm	ANT	CC	CI	CU	CS	LM	MR	PL	
C608	Ø50									5

LAT



Ref.	mm	AN	BL	CB	CI	CS	CU	LM	NE	NS	PB	PL	
SV-CR50	Ø50												2

ZK



Bocallave redonda de seguridad

Ref.	mm	AN	ANTR	BL	CB	CI	CS	CU	LM	MR	NE	NM	NMM	PB	PL	
C630	Ø50															10

LAT



Ref.	mm	ANTR	BL	CB	CI	CS	LM	NE	NM	NMM	PVLM	
12BY	Ø50											10

ZK

- AN Anticato
- CB Cromo Brillo
- CS Cromo Satinado
- MR Marrón
- NMM Níquel Mate Mate
- PB Pulido Brillo
- PVLM PVD Lat. Mate
- ANTR Antracita
- CC Cromo Combinado
- CU Cuero
- NE Negro
- NM.OP Níq. Mat. Opaco
- PS Pulido Satin.
- BL Blanco
- CI Cuero Inglés
- LM Latón Mate
- NM Níquel Mate
- NS Níquel Satinado
- PL Plata



Ref.	mm	AN	ANTR	BL	CB	CI	CS	CU	LM	NE	NMM	NS	PB	PL	PVLM	
SV-495	Ø35															5

ZK

JANDEL ORIGINAL





Ref.	mm	CB	CI	CS	LM	NM	PB	
C611	50X50							10

LAT



Ref.	mm	ANTR	BL	CB	CI	CS	LM	NE	NM	NMM	PVLM	
34BY	50X50											10

ZK



Bocallave cuadrada de seguridad

Ref.	mm	ANTR	BL	CB	CI	CS	LM	NE	NM	NMM	PB	
C635	50X50											10

LAT



Ref.	BL	CB	CI	CS	CU	LM	NE	NM	PB	
C902										20

ZK

- AN Anticato
- CB Cromo Brillo
- CS Cromo Satinado
- MR Marrón
- NMM Níquel Mate Mate
- PB Pulido Brillo
- PVLM PVD Lat. Mate
- ANTR Antracita
- CC Cromo Combinado
- CU Cuero
- NE Negro
- NM.OP Níq. Mat. Opaco
- PS Pulido Satin.
- BL Blanco
- CI Cuero Inglés
- LM Latón Mate
- NM Níquel Mate
- NS Níquel Satinado
- PL Plata



Ref.	mm	ANTR	BL	CB	CI	CS	LM	NE	NM	NMM	
12WC	Ø50										5

ZK



Ref.	mm	CB	CC	CI	CS	LM	NM	PB	
C621	Ø50								5

ZK



Ref.	mm	BL	CB	CI	CS	LM	NE	NM	NMM	
34WC	Ø50									5

ZK



Ref.	mm	ANTR	BL	CB	CI	CS	LM	NE	NMM	NS	
SVCC35	Ø35										5

ZK



Ref.	mm	AN	ANTR	CB	CI	CS	CU	LM	MR	NM	NMOP	PB	PL	
7610	Ø56 Ø48 (interior)													5

ZK



Ref.	mm	ANTR	CB	CI	CS	LM	NM	NMOP	PB	
7630	∅56 Ø48 (interior)									5

ZK



7510



7530

Ref.	mm	ANTR	BL	CB	CI	CS	CU	EFLM	LM	MR	NE	NM	NM.OP	PB	PL	
7510	Ø56 Ø48 (interior)															1
7530	56x56 Ø48 (interior)															1

ZK

- AN Anticato
- ANTR Antracita
- BL Blanco
- CB Cromo Brillo
- CC Cromo Combinado
- CI Cuero Inglés
- CS Cromo Satinado
- CU Cuero
- LM Latón Mate
- MR Marrón
- NE Negro
- NM Níquel Mate
- NMM Níquel Mate Mate
- NM.OP Níq. Mat. Opaco
- NS Níquel Satinado
- PB Pulido Brillo
- PS Pulido Satin.
- PL Plata
- PVLML PVD Lat. Mate



Ref.	mm	CB	CI	CS	CU	LM	NM	PB	
C410	129x34								10
C420	79x34								10

LAT



Ref.	Medidas	CI	NM	PS	
C450	137x33				10
C460	87x33				10

LAT



NEW

Ref.	mm	CI	
T490 (porc. craquelé)	128x33		20
T491 (porc. beige)	128x33		20
T492 (porc. blanca)	128x33		20
A490 (porc. craquelé)	88x33		20
A491 (porc. beige)	88x33		20
A492 (porc. blanca)	88x33		20

LAT

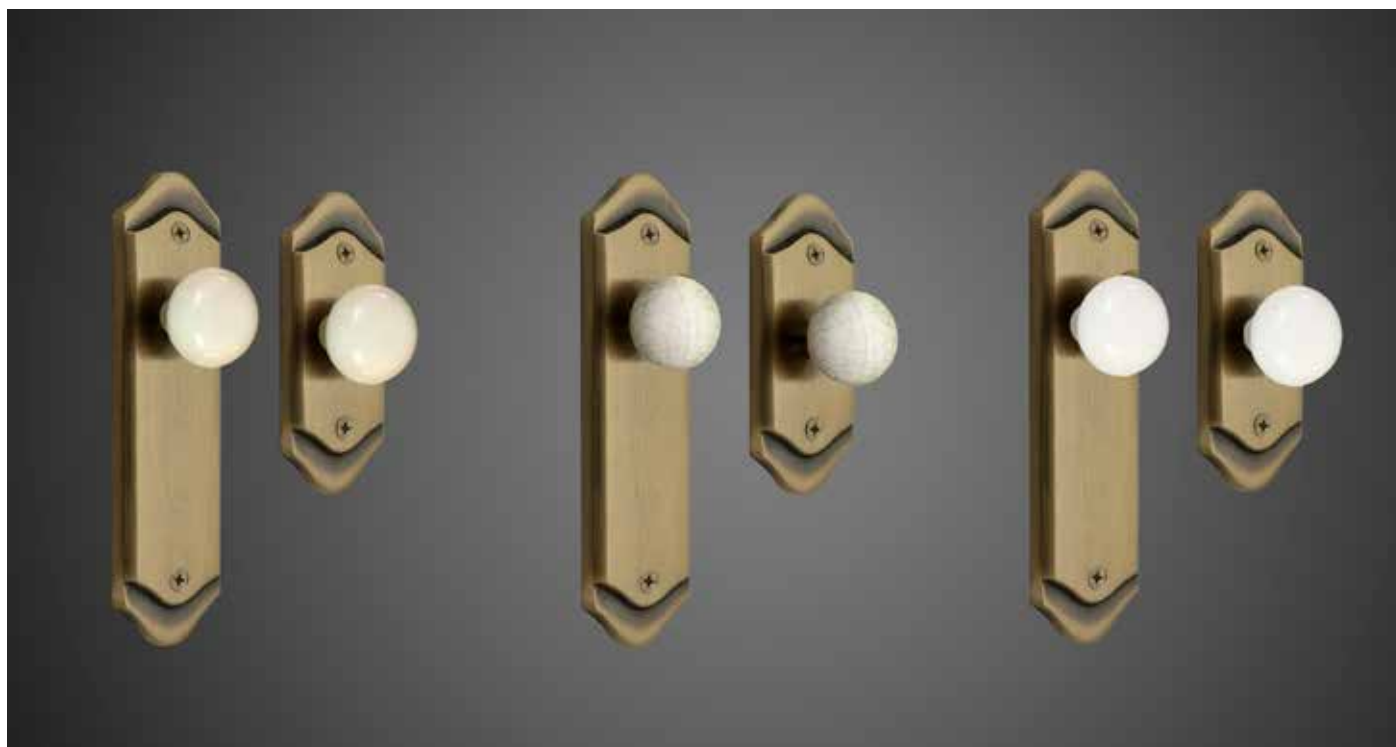

- AN Anticato
- CB Cromo Brillo
- CS Cromo Satinado
- MR Marrón
- NMM Níquel Mate Mate
- PB Pulido Brillo
- PVLM PVD Lat. Mate
- ANTR Antracita
- CC Cromo Combinado
- CU Cuero
- NE Negro
- NM.OP Níq. Mat. Opaco
- PS Pulido Satin.
- BL Blanco
- CI Cuero Inglés
- LM Latón Mate
- NM Níquel Mate
- NS Níquel Satinado
- PL Plata

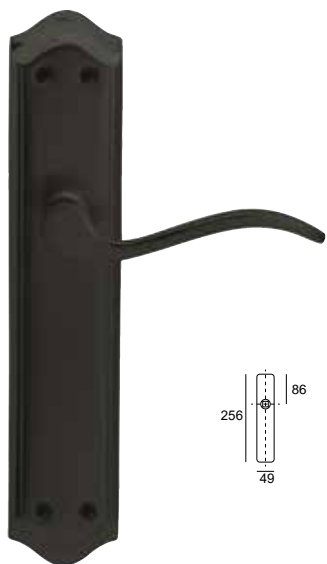

AL

Ref.	Denominación	mm	NE		
EQ-202	Jgo. Manivela	256x49		2	20
EQ-M202	Manillón	256x49		4	40
EQ-L202	Placa limpieza	256x49		10	100
EQ-C202	Asa corta c/placa	256x49		4	40
EQ-T202	Tirador armario	123x35		20	200
EQ-A202	Tirador maletero	83x35		20	200
EQ-P202	Placa pomo fijo	256x49		2	40
EQ-P202MV	Placa pomo móvil	256x49		2	40

AL

Ref.	Denominación	mm	PS		
EQ-203	Jgo. Manivela	256x49		2	20
EQ-M203	Manillón	256x49		4	40
EQ-L203	Placa limpieza	256x49		10	100
EQ-C203	Asa corta c/placa	256x49		4	40
EQ-T203	Tirador armario	123x35		20	200
EQ-A203	Tirador maletero	83x35		20	200
EQ-P203	Placa pomo fijo	256x49		2	40
EQ-P203MV	Placa pomo móvil	256x49		2	40

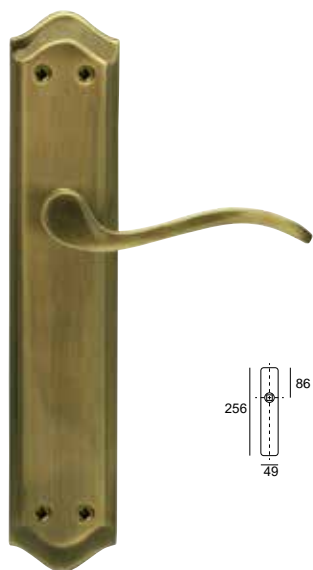

AL

Ref.	Denominación	mm	CU		
EQ-204	Jgo. Manivela	256x49		2	20
EQ-M204	Manillón	256x49		4	40
EQ-L204	Placa limpieza	256x49		10	100
EQ-C204	Asa corta c/placa	256x49		4	40
EQ-T204	Tirador armario	123x35		20	200
EQ-A204	Tirador maletero	83x35		20	200
EQ-P204	Placa pomo fijo	256x49		2	40
EQ-P204MV	Placa pomo móvil	256x49		2	40

AL

Ref.	Denominación	mm	NS		
EQ-205	Jgo. Manivela	256x49		2	20
EQ-M205	Manillón	256x49		4	40
EQ-L205	Placa limpieza	256x49		10	100
EQ-C205	Asa corta c/placa	256x49		4	40
EQ-T205	Tirador armario	123x35		20	200
EQ-A205	Tirador maletero	83x35		20	200
EQ-P205	Placa pomo fijo	256x49		2	40
EQ-P205MV	Placa pomo móvil	256x49		2	40

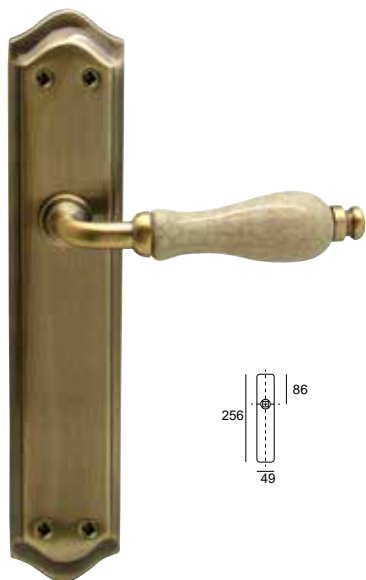

AL / LAT

Ref.	Denom.	AN	CI	CU	NS	PL	PS		
EQ-206	Jgo. Man. CRAQUELÉ							1	20
	Jgo. Man. BEIGE							1	20
	Jgo. Man. BLANCA							1	20
EQ-T290	Tirador armario CRAQUELÉ							20	200
EQ-T291	Tirador armario BEIGE							20	200
EQ-T292	Tirador armario BLANCA							20	200
EQ-A290	Tirador malet. CRAQUELÉ							20	200
EQ-A291	Tirador malet. BEIGE							20	200
EQ-A292	Tirador malet. BLANCA							20	200

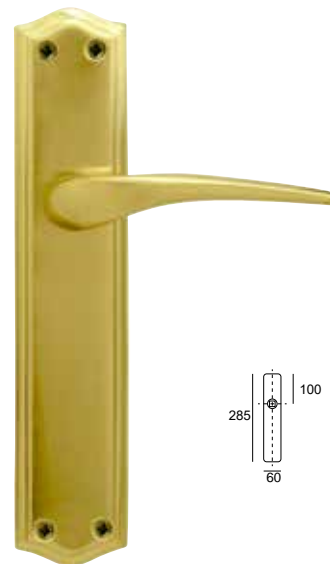

ZK

Ref.	Denominación	mm	PS		
EQ-207	Jgo. Manivela	285x60		1	20
EQ-M207	Manillón	285x60		2	40
EQ-L207	Placa limpieza	285x60		10	100
EQ-C207	Asa corta c/placa	285x60		4	40
EQ-T203	Tirador armario	123x35		20	200
EQ-A203	Tirador maletero	83x35		20	200
EQ-P207	Placa pomo fijo	285x60		2	40
EQ-P207MV	Placa pomo móvil	285X60		2	40

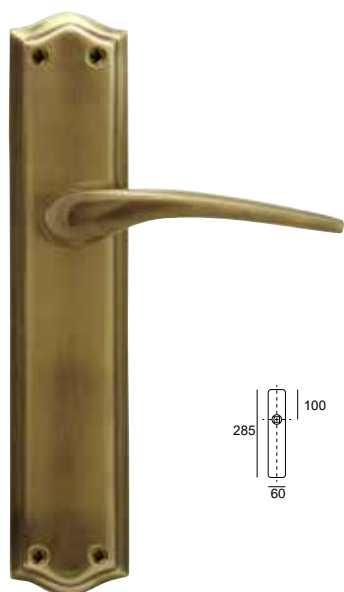

ZK

Ref.	Denominación	mm	CU		
EQ-208	Jgo. Manivela	285x60		1	20
EQ-M208	Manillón	285x60		2	40
EQ-L208	Placa limpieza	285x60		10	100
EQ-C208	Asa corta c/placa	285x60		4	40
EQ-T204	Tirador armario	123x35		20	200
EQ-A204	Tirador maletero	83x35		20	200
EQ-P208	Placa pomo fijo	285x60		2	40
EQ-P208MV	Placa pomo móvil	285X60		2	40

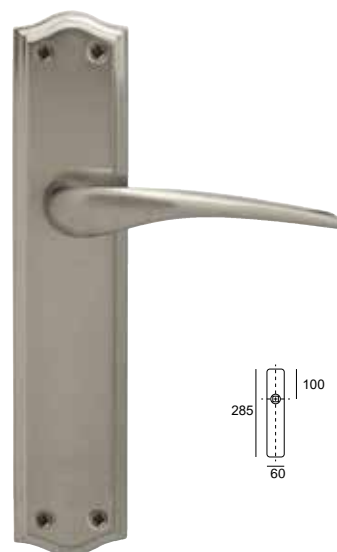

ZK

Ref.	Denominación	mm	NS		
EQ-209	Jgo. Manivela	285x60		1	20
EQ-M209	Manillón	285x60		2	40
EQ-L209	Placa limpieza	285x60		10	100
EQ-C209	Asa corta c/placa	285x60		4	40
EQ-T205	Tirador armario	123x35		20	200
EQ-A205	Tirador maletero	83x35		20	200
EQ-P209	Placa pomo fijo	285x60		2	40
EQ-P209MV	Placa pomo móvil	285X60		2	40

- AN Anticato
- CB Cromo Brillo
- CS Cromo Satinado
- NMM Níq. Mate Mate
- PB Pulido Brillo
- ANTR Antracita
- CI Cuero Inglés
- LM Latón Mate
- NS Níquel Satinado
- PL Plata
- BL Blanco
- CU Cuero
- NE Negro
- NS/NB Níq. Sat / Níq. Br.
- PS Pulido Satin.



JANDEL EQUAL

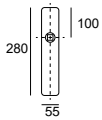

ZK

Ref.	Denominación	mm	CU	NS	PS		
EQ-210	Jgo. Manivela	280x55				1	20
EQ-M210	Manillón	280x55				2	40
EQ-L210	Placa limpieza	280x55				10	100
EQ-C210	Asa corta c/placa	280x55				4	40
EQ-P210	Placa pomo fijo	280x55				2	40
EQ-T150	Tirador armario	129x34				20	200
EQ-A150	Tiradro maletero	79x34				20	200
EQ-P210MV	Placa pomo móvil	280x55				2	40

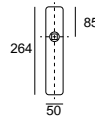

AL

Ref.	Denominación	mm	CI	NS	PS		
EQ-868	Jgo. Manivela	264x50				2	20
EQ-M868	Manillón	264x50				2	40
EQ-L868	Placa limpieza	264x50				10	100
EQ-C868	Asa corta c/placa	264x50				4	40
EQ-T203	Tirador armario	125x35				20	200
EQ-A203	Tirador maletero	83x35				20	200
EQ-P868	Placa pomo fijo	264x50				2	40
EQ-P868MV	Placa pomo móvil	264x50				2	40





JANDEL EQUAL

- AN Anticato
- CB Cromo Brillo
- CS Cromo Satinado
- NMM Níq. Mate Mate
- PB Pulido Brillo
- ANTR Antracita
- CI Cuero Inglés
- LM Latón Mate
- NS Níquel Satinado
- PL Plata
- BL Blanco
- CU Cuero
- NE Negro
- NS/NB Níq. Sat / Níq. Br.
- PS Pulido Satin.







EQ-R204 AL

mm	CU		
Ø 50		1	20





EQ-R150 AL

mm	CU	LM	NE	NS	PB		
Ø 50						1	20





EQ-R200 AL

mm	BL	LM	NE	NS	NS/NB		
Ø 50						1	20



SV-R250 AL

mm	NS/NB		
Ø 50		1	20

● AN Anticato
● ANTR Antracita
○ BL Blanco

● CB Cromo Brillo
● CI Cuero Inglés
● CU Cuero



● CS Cromo Satinado
● LM Latón Mate
● NE Negro

● NMM Níq. Mate Mate
● NS Níquel Satinado
● NS/NB Níq. Sat / Níq. Br.

● PB Pulido Brillo
● PL Plata
● PS Pulido Satin.





SV-R300 AL

mm	NS		
Ø 50		1	20





SV-R333 AL

mm	NE		
Ø 50		1	20

JANDEL EQUAL





SV-R350 AL

mm	NS/NB		
Ø 50		1	20





SV-R600 AL

mm	ANTR	BL	NE	NS	NS/ NB		
Ø 50						1	20





NEW

SV-R700 AL

mm	ANTR	NE	NS		
Ø 50				1	20





SV-R800 AL

mm	NS		
Ø 50		1	20



NEW

SV-R850 AL



mm	ANTR	LM	NE	NS		
Ø 50					1	20



NEW

Tapa Pomos

SV-R655 AL

mm	CU	LM	NE	NS	PB		
Ø 65						1	20

● AN Anticato
● ANTR Antracita
○ BL Blanco

● CB Cromo Brillo
● CI Cuero Inglés
● CU Cuero

● CS Cromo Satinado
● LM Latón Mate
● NE Negro

● NMM Níq. Mate Mate
● NS Níquel Satinado
● NS/NB Níq. Sat / Níq. Br.

● PB Pulido Brillo
● PL Plata
● PS Pulido Satin.

NEW



EQ-C150 AL

mm	NS		
50x50		1	20



SV-C200 AL

mm	NE	NS		
50x50			1	20

NEW



SV-C350 AL

mm	NS/NB		
50x50		1	20



SV-C400 AL

mm	ANTR	BL	LM	NE	NS	NS/NB		
50x50							1	20



SV-C700 AL

mm	NE	NS		
50x50			1	20



SV-C750 AL

mm	NS		
50x50		1	20



JANDEL EQUAL

- | | | | | |
|------------------|-------------------|---------------------|-----------------------------|--------------------|
| ● AN Anticato | ● CB Cromo Brillo | ● CS Cromo Satinado | ● NMM Níq. Mate Mate | ● PB Pulido Brillo |
| ● ANTR Antracita | ● CI Cuero Inglés | ● LM Latón Mate | ● NS Níquel Satinado | ● PL Plata |
| ○ BL Blanco | ● CU Cuero | ● NE Negro | ● NS/NB Níq. Sat / Níq. Br. | ● PS Pulido Satin. |

MANILLAS EN NEGRO



EQ-R150



SV-R700



EQ-R200



SV-R850



SV-R333



SV-C200



SV-R600



SV-C400



SV-R655



SV-C700

MANILLAS EN LATÓN MATE



EQ-R150



EQ-R200



SV-C400



SV-R850

● AN Anticato
● ANTR Antracita
○ BL Blanco

● CB Cromo Brillo
● CI Cuero Inglés
● CU Cuero

● CS Cromo Satinado
● LM Latón Mate
● NE Negro

● NMM Níq. Mate Mate
● NS Níquel Satinado
● NS/NB Níq. Sat / Níq. Br.

● PB Pulido Brillo
● PL Plata
● PS Pulido Satin.

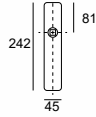
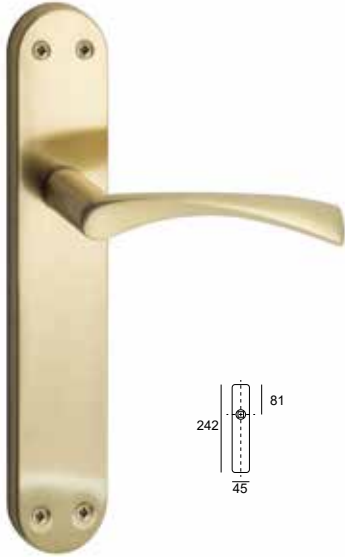

AL

Ref.	CU	LM	NE	NS	PB		
SV-P150						2	20

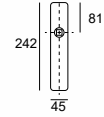

AL

Ref.	BL	LM	NE	NS		
SV-P200					2	20

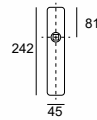
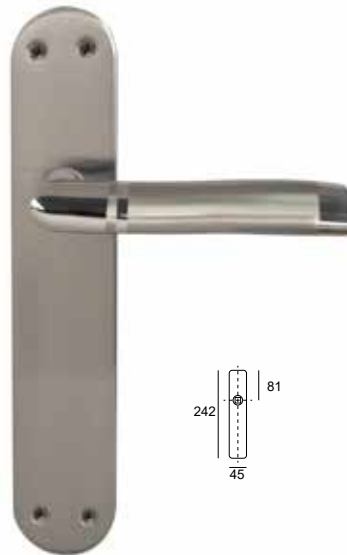

AL

Ref.	NS/NB		
SV-P250		2	20

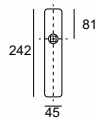

AL

Ref.	NS		
SV-P300		2	20

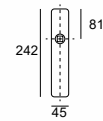
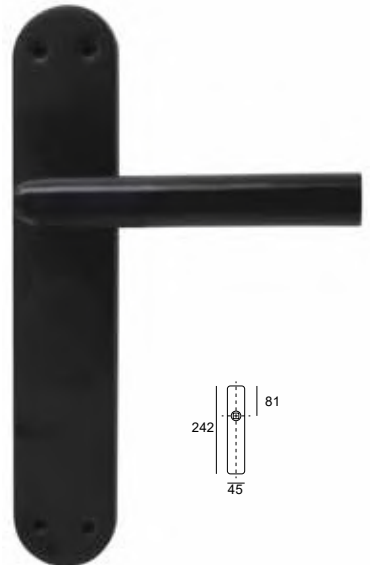

AL

Ref.	NE		
SV-P333		1	20

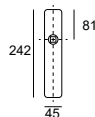

AL

Ref.	NS/NB		
SV-P350		2	20

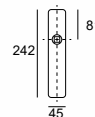

AL

Ref.	ANTR	BL	NE	NS		
SV-P600					1	20

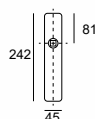
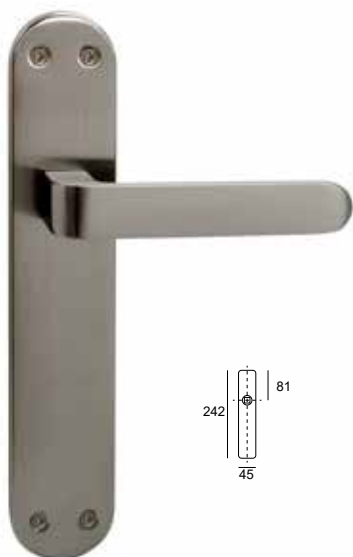

NEW

AL

Ref.	ANTR	LM	NE	NS		
SV-P850					1	20

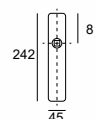

NEW

AL

Ref.	ANTR	NE	NS		
SV-P700				1	20





JANDEL EQUAL

- AN Anticato
- CB Cromo Brillo
- CS Cromo Satinado
- NMM Níq. Mate Mate
- PB Pulido Brillo
- ANTR Antracita
- CI Cuero Inglés
- LM Latón Mate
- NS Níquel Satinado
- PL Plata
- BL Blanco
- CU Cuero
- NE Negro
- NS/NB Níq. Sat / Níq. Br.
- PS Pulido Satin.





AL

Ref.	NE	NS		
SV-PC20			1	20

NEW





AL

Ref.	NS/NB		
SV-PC35		1	20





AL

Ref.	NE	NS		
SV-PC70			1	20



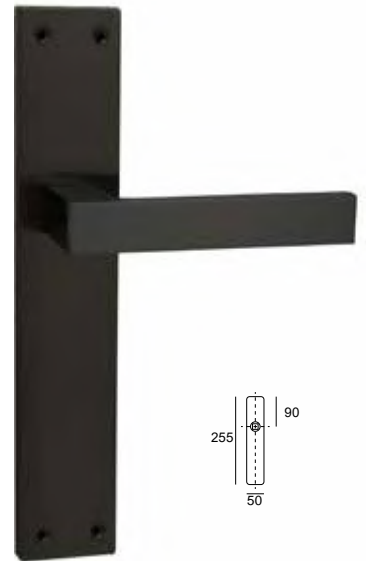

AL

Ref.	NS		
SV-PC75		1	20



AL

Ref.	ANTR	BL	LM	NE	NS	NS/NB		
SV-P400							1	20



JANDEL EQUAL

- | | | | | |
|------------------|-------------------|---------------------|-----------------------------|--------------------|
| ● AN Anticato | ● CB Cromo Brillo | ● CS Cromo Satinado | ● NMM Níq. Mate Mate | ● PB Pulido Brillo |
| ● ANTR Antracita | ● CI Cuero Inglés | ● LM Latón Mate | ● NS Níquel Satinado | ● PL Plata |
| ○ BL Blanco | ● CU Cuero | ● NE Negro | ● NS/NB Níq. Sat / Níq. Br. | ● PS Pulido Satin. |

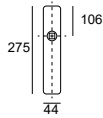

ZK

Ref.	NE		
SV-P398		1	20

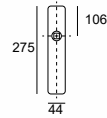

ZK

Ref.	NE		
SV-P500		1	20

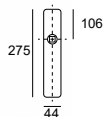

ZK

Ref.	NE		
SV-PP50		2	40

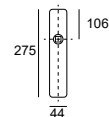

ZK

Ref.	NE		
SV-M500		5	40



- | | | | | |
|------------------|-------------------|---------------------|-----------------------------|--------------------|
| ● AN Anticato | ● CB Cromo Brillo | ● CS Cromo Satinado | ● NMM Níq. Mate Mate | ● PB Pulido Brillo |
| ● ANTR Antracita | ● CI Cuero Inglés | ● LM Latón Mate | ● NS Níquel Satinado | ● PL Plata |
| ○ BL Blanco | ● CU Cuero | ● NE Negro | ● NS/NB Níq. Sat / Níq. Br. | ● PS Pulido Satin. |



AL

Ref.	mm (centr.)	CU	LM	NE	NS	PB	
SV-M150	200						1

AL

Ref.	mm (centr.)	NS/NB	
SV-M350	180		1

JANDEL EQUAL



AL

Ref.	mm (centr.)	BL	LM	NE	NS	NS/NB	
SV-M200	200						1



Ref.	mm (entre cent.)	INOX	
EQ-M802 (Ø 25)	225 (200)		2
	325 (300)		2
	625 (600)		2
	925 (900)		2
	1225 (1200)		2

AL

INOX

Ref.	mm (centr.)	ANTR	BL	CB	CS	LM	NE	NS	
SV-M335	200								1



AL

Ref.	mm (centr.)	BL	NE	NS	
SV-M600	200				1

- AN Anticato
- ANTR Antracita
- BL Blanco

- CB Cromo Brillo
- CI Cuero Inglés
- CU Cuero

- CS Cromo Satinado
- LM Latón Mate
- NE Negro

- NMM Níq. Mate Mate
- NS Níquel Satinado
- NS/NB Níq. Sat / Níq. Br.

- PB Pulido Brillo
- PL Plata
- PS Pulido Satin.



NEW

AL

Ref.	mm (centr.)	NS	
SV-MC15	200		1



AL

Ref.	mm (centr.)	NE	NS	
SV-MC20	200			1



NEW

AL

Ref.	mm (centr.)	NS/NB	
SV-MC35	200		1



AL

Ref.	mm (centr.)	BL	NE	NS	NS/NB	
SV-M400	200					1



JANDEL EQUAL

- | | | | | |
|------------------|-------------------|---------------------|-----------------------------|--------------------|
| ● AN Anticato | ● CB Cromo Brillo | ● CS Cromo Satinado | ● NMM Níq. Mate Mate | ● PB Pulido Brillo |
| ● ANTR Antracita | ● CI Cuero Inglés | ● LM Latón Mate | ● NS Níquel Satinado | ● PL Plata |
| ○ BL Blanco | ● CU Cuero | ● NE Negro | ● NS/NB Níq. Sat / Níq. Br. | ● PS Pulido Satin. |

* Medidas especiales consultar con el departamento comercial



INOX

Ref.	A (B)	NE	
EQ-M800 Ø30 mm	300 (210)		2
	400 (300)		2
	500 (300)		2
	600 (400)		2
	800 (600)		2
	1200 (900)		2
	1500 (1300)		1
	1800 (1500)		1

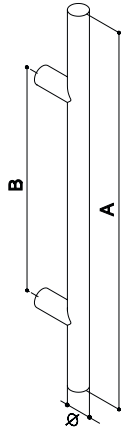

INOX

Ref.	A (B)	NE	
EQ-M810 Ø30 mm Desplazado 45°	300 (210)		2
	400 (300)		2
	500 (300)		2
	600 (400)		2
	800 (600)		2
	1200 (900)		2

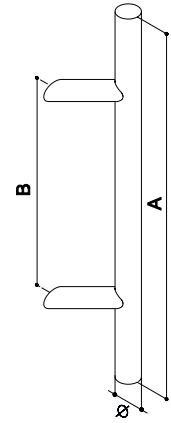

INOX

Ref.	A (B)	NE	
EQ-M831 ■25 x 25 mm	300 (210)		2
	400 (300)		2
	500 (300)		2
	600 (400)		2
	800 (600)		2
	1200 (900)		2
	1500 (1300)		1
	1800 (1500)		1

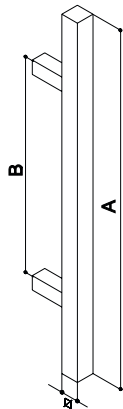

NEW

INOX

Ref.	A (B)	NE	
SV-M861 ■25 x 25 mm Desplazado 45°	400 (210)		
	500 (300)		
	600 (400)		
	700 (500)		
	800 (600)		
	1200 (900)		

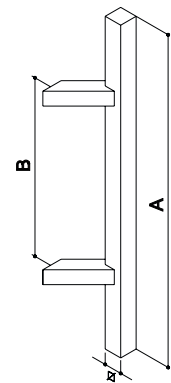



- | | | | | |
|------------------|-------------------|---------------------|-----------------------------|--------------------|
| ● AN Anticato | ● CB Cromo Brillo | ● CS Cromo Satinado | ● NMM Níq. Mate Mate | ● PB Pulido Brillo |
| ● ANTR Antracita | ● CI Cuero Inglés | ● LM Latón Mate | ● NS Níquel Satinado | ● PL Plata |
| ○ BL Blanco | ● CU Cuero | ● NE Negro | ● NS/NB Níq. Sat / Níq. Br. | ● PS Pulido Satin. |

JANDEL EQUAL





INOX

Ref.	A (B)	NE	
SV-M360 (■ 20)	220 (200)		2
	270 (250)		2
	320 (300)		2
	420 (400)		2
	470 (450)		2

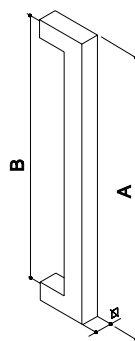

NEW

INOX

Ref.	A (B)	NE	
EQ-M802K (■ 25)	225 (200)		2
	325 (300)		2
	625 (600)		2
	925 (900)		2
	1225 (1200)		2

● AN Anticato
● ANTR Antracita
○ BL Blanco

● CB Cromo Brillo
● CI Cuero Inglés
● CU Cuero

● CS Cromo Satinado
● LM Latón Mate
● NE Negro

● NMM Níq. Mate Mate
● NS Níquel Satinado
● NS/NB Níq. Sat / Níq. Br.

● PB Pulido Brillo
● PL Plata
● PS Pulido Satin.



Ref.	mm	BL	CU	LM	NE	NS	PB	
SV-MP15	242x45							2
SV-PP15	242x45							2
SV-C150	242x45							4

AL / LAT



JANDEL EQUAL

- | | | | | |
|------------------|-------------------|---------------------|-----------------------------|--------------------|
| ● AN Anticato | ● CB Cromo Brillo | ● CS Cromo Satinado | ● NMM Níq. Mate Mate | ● PB Pulido Brillo |
| ● ANTR Antracita | ● CI Cuero Inglés | ● LM Latón Mate | ● NS Níquel Satinado | ● PL Plata |
| ○ BL Blanco | ● CU Cuero | ● NE Negro | ● NS/NB Níq. Sat / Níq. Br. | ● PS Pulido Satin. |



ZK

Ref.	Ø mm	ANTR	BL	CU	LM	NE	NS	PB	
EQ-285Z	50								10



ZK

Ref.	Ø mm	ANTR	BL	CU	LM	NE	NS	PB	
SV-BR25	50								10

INOX

Ref.	Ø mm	NE	
SV-B304	52		10
SV-B305	52		10



ZK

Ref.	Ømm	ANTR	BL	CU	LM	NE	NS	PB	
SV-CR50	50								2

ZK

Ref.	Ømm	ANTR	BL	CU	LM	NE	NMM	NS	PB	
SV-495	35									5



ZK

Ref.	AN	ANTR	BL	CI	CS	CU	LM	NE	NMM	NS	PB	PL	
EQ-1197													10



ZK

Ref.	mm	ANTR	BL	CB	CS	NE	NS	NS/NB	
SV-BC15	50x50								10
SV-BC25	50x50								10



INOX

Ref.	mm	NE	
SV-B303	50x50		10
SV-B308	50x50		10

ZK

Ref.	mm	ANTR	BL	CB	CI	CS	LM	NE	NMM	NS	
SV-CC35	35x35										5



ZK

Ref.	mm	ANTR	BL	CB	CS	NE	NS	NS/NB	
SV-CC50	50x50								2



ZK

Ref.	BL	CB	CI	CS	CU	LM	NE	NS	PB	
C902										20

● AN Anticato
● ANTR Antracita
○ BL Blanco

● CB Cromo Brillo
● CI Cuero Inglés
● CU Cuero

● CS Cromo Satinado
● LM Latón Mate
● NE Negro

● NMM Niq. Mate Mate
● NS Níquel Satinado
● NS/NB Niq. Sat / Niq. Br.

● PB Pulido Brillo
● PL Plata
● PS Pulido Satin.



ZK

Ref.	BL	CB	CS	NE	NS	PB	
SVDEDALC						-	20
SVDEDALR							20

ZK

Ref.	ANTR	BL	CB	CS	CU	LM	NE	NS	PB		
SV-CCDR										1	20

Ø56 mm (Ø48 interior)



ZK

Ref.	ANTR	BL	CB	CS	CU	LM	NE	NS	PB		
SV-KITR										1	20

Ø56 mm (Ø48 interior)
Frontal **16 mm**. Especial para picaporte unificado de 70 mm.



ZK

Ref.	BL	CB	CS	CU	LM	NE	NS	PB		
KITR20									1	20

Ø56 mm (Ø48 interior)
Frontal **20 mm**. Especial para picaporte unificado de 70 mm.

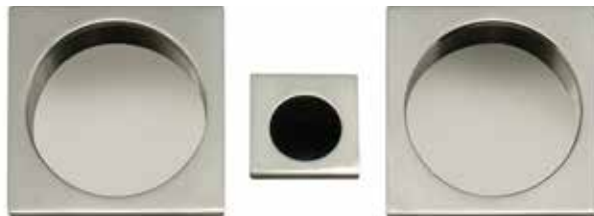

ZK

Ref.	ANTR	BL	CB	CS	LM	NE	NS		
SV-CCDC								1	20

56 x 56 mm (Ø48 interior)



ZK

Ref.	ANTR	BL	CB	CS	LM	NE	NS		
SV-KITC								1	20

56 x 56 (Ø48 interior)

Frontal **16 mm**. Especial para picaporte unificado de 70 mm.



NEW

ZK

ZK

Ref.	BL	CB	CS	NE	NS		
KITC20						1	20

56 x 56 mm (Ø48 interior)

Frontal **20 mm**. Especial para picaporte unificado de 70 mm.

Ref.	NS	
PICOLORO		10

- AN Anticato
- ANTR Antracita
- BL Blanco

- CB Cromo Brillo
- CI Cuero Inglés
- CU Cuero

- CS Cromo Satinado
- LM Latón Mate
- NE Negro

- NMM Níq. Mate Mate
- NS Níquel Satinado
- NS/NB Níq. Sat / Níq. Br.

- PB Pulido Brillo
- PL Plata
- PS Pulido Satin.



Kits corredera con bombillo 40 mm con 3 llaves



ZK

Ref.	mm	CU	NE	NS	PB	
SV-KITB	Ø56 (Ø48 int.)					1

ZK

Ref.	mm	CB	CS	NE	NS	
SV-KITBC	■ 56 (Ø48 int.)					1

JANDEL EQUAL



ZK

Ref.	mm	BL	CU	NE	NS	PB	
PU-47	47						10
PU-70	70						10



ZK

Ref.	mm	CU	LM	NE	NS	
SV-PSMN	Ø70					15



ZK

Ref.	Ø mm	MIXTA	NS	PB	
MR-2542	14(25-42)				12



ZK

Ref.	Ø mm	MIXTA	NE	NS	PB	
MR-3560	14(35-60)					12



ZK

Ref.	Ø mm	NE	NS	
SV-TOPE	22x30			25



AL

Ref.	mm	ANTR	BL	CB	CI	CS	CU	LM	NE	NS	PB	
SV-T150	129x34											20
SV-A150	79x34											20

AL

Ref.	mm	ANTR	BL	CB	CI	CS	LM	NE	NS	PB	
SV-T401	132x38										20
SV-A401	81x34										20

- AN Anticato
- ANTR Antracita
- BL Blanco

- CB Cromo Brillo
- CI Cuero Inglés
- CU Cuero

- CS Cromo Satinado
- LM Latón Mate
- NE Negro

- NMM Níq. Mate Mate
- NS Níquel Satinado
- NS/NB Níq. Sat / Níq. Br.

- PB Pulido Brillo
- PL Plata
- PS Pulido Satin.



ZK

Ref.	mm	ANTR	BL	CU	NE	NS	PB		
PH-100D	100x57x2							20	240
PH-100I	100x57x2							20	240



ZK

Ref.	mm	BL	CU	NE	NS	PB		
PH-95D	95x54x2						20	240
PH-95I	95x54x2						20	240



INOX

Ref.	mm	INOX		
PI-100D	100x57x2		20	240
PI-100I	100x57x2		20	240



INOX

Ref.	mm	INOX		
PI-95D	95x53x2		20	240
PI-95I	95x53x2		20	240



ZK

Ref.	mm	BL	CU	LM	NE		
BH-90CD	90x65x2.5					10	100
BH-90CI	90x65x2.5					10	100
BH-80CD	80x60x2.5	-				10	100
BH-80CI	80x60x2.5	-				10	100



ZK

Ref.	mm	BL	CU	LM	NE		
BH-90RD	90x65x2.5					10	100
BH-90RI	90x65x2.5					10	100



INOX

Ref.	mm	INOX		
BI-90CD	90x65x2.5		10	100
BI-90CI	90x65x2.5		10	100
BI-80CD	80x60x2.5		10	100
BI-80CI	80x60x2.5		10	100



INOX

Ref.	mm	INOX		
BI-90RD	90x65x2.5		10	100
BI-90RI	90x65x2.5		10	100

- AN Anticato
- ANTR Antracita
- BL Blanco

- CB Cromo Brillo
- CI Cuero Inglés
- CU Cuero

- CS Cromo Satinado
- LM Latón Mate
- NE Negro

- NMM Níq. Mate Mate
- NS Níquel Satinado
- NS/NB Níq. Sat / Níq. Br.

- PB Pulido Brillo
- PL Plata
- PS Pulido Satin.



NEW

AL

Ref.	mm	NE	NS	
SV-PR	242x45			10



NEW

AL

Ref.	mm	NE	NS	
SV-PC	255x50			10

● PB Pulido Brillo
● PS Pulido Satin.
● NS Níquel Satin.

● CU Cuero
● CI Cuero Inglés
● CB Cromo Brillo

● NS/NB Níq. Sat / Níq. Br
● LM Latón Mate
● NE Negro

○ BL Blanco
● CS Cromo Satinado
● PL Plata

● AN Anticato
● NMM Níq. Mate Mate

Accesorios Técnicos

*Taladro condena y desbloqueo 1€ Neto

*Taladro bocallave 0,50€ Neto

*Taladro bocallave cortinilla 2,50€ Neto



8X8

Fijación expositor cuadradillo



Ø8

Fijación expositor roscado pomo

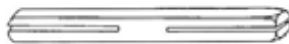

8x85	8x120	8x150	8x200

Cuadradillo fresado de 8 mm

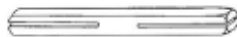

6x80	6x100	6x120

Cuadradillo fresado de 6 mm



de 7 a 6	de 8 a 6	de 8 a 7

Reductor



8x65	8x85

Cuadradillo de expansión



Muelle

Muelle espiral

LINEA INOX

ELEVADA RESISTENCIA
A LA CORROSIÓN

JANDEL INOX



Ref.	mm	INOX	NE		
SV-R302	Ø 52			1	40



Ref.	mm	INOX	NE		
SV-X302	60x32			1	40



Ref.	mm	INOX	NE		
SV-F302	170x170			1	10

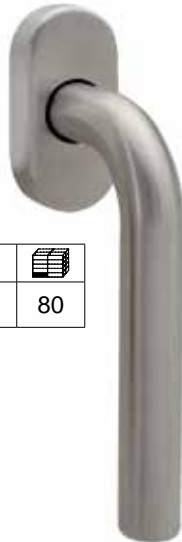

Ref.	mm	INOX	NE		
SV-G302	60x32			2	80

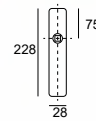

Ref.	INOX	NE		
SV-E302			2	40

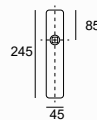

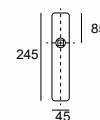

Ref.	INOX	NE		
SV-P301			1	20





Ref.	INOX	NE		
SV-P302			1	20





Ref.	mm	INOX		
SV-R336	Ø 52		1	40





Ref.	mm	INOX		
SV-X336	60x32		1	40





Ref.	mm	INOX		
SV-F336	170x170		1	10



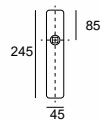

Ref.	mm	INOX		
SV-G336	60x32		4	80



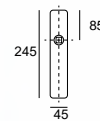
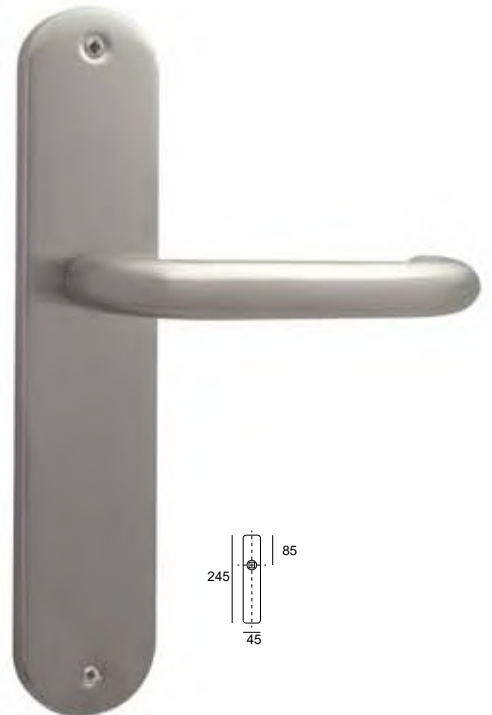

Ref.	INOX		
SV-P336		1	20





Ref.	INOX		
SV-P337		1	20





Ref.	mm	INOX	NE	PVLM		
SV-R338	Ø 52				1	40





Ref.	mm	INOX		
SV-X338	60x32		1	40





Ref.	mm	INOX		
SV-G338	60x32		4	80

El INOX, elevada resistencia a la corrosión



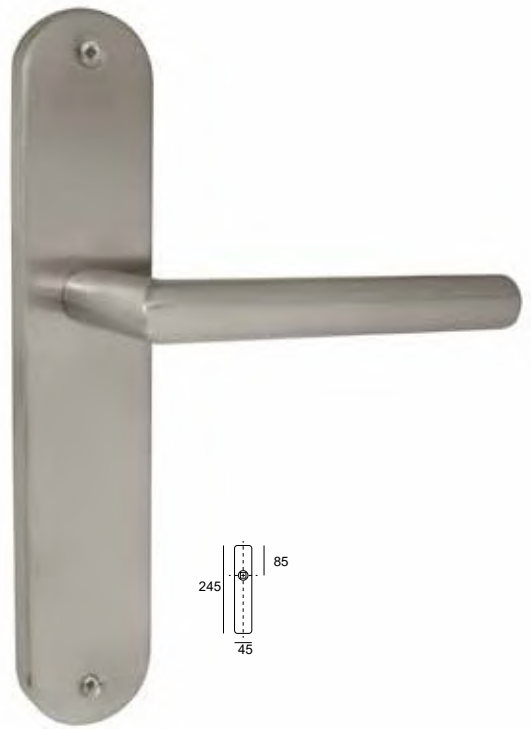

Ref.	INOX		
SV-P338		1	20





Ref.	INOX	NE		
SV-P339			1	20



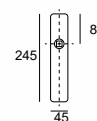

Ref.	mm	INOX		
SV-R318 MACIZA	Ø 52		1	20
SV-R358 HUECA	Ø 52		1	40

NEW



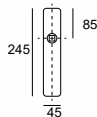

Ref.	INOX		
SV-P318		1	20



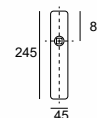

Ref.	INOX		
SV-P319		1	20



Ref.	INOX		
SV-P334		1	20





Ref.	mm	INOX		
SV-C334	50x50		1	40

JANDEL INOX





NEW

Ref.	mm	INOX		
SV-R258	Ø 52		1	20





NEW

Ref.	mm	INOX		
SV-C413	53x53		1	20





NEW

Ref.	INOX		
SV-P258		1	20



NEW

Ref.	INOX		
SV-P413		1	20





Ref.	mm (entre cent.)	INOX	NE	
SV-M302	150		-	4
	200		-	4
	250		-	4
	300		-	4



Ref.	mm (entre cent.)	INOX	
SV-M318	200		4



Ref.	mm (entre cent.)	INOX	NE	PVLM	
SV-M338	150		-	-	1
	200				1



NEW

Ref.	mm (entre cent.)	INOX	
SV-M258	200		1



Ref.	mm (entre cent.)	INOX	
SV-M365	200		1



Ref.	mm (entre cent.)	INOX	NE	
SV-M360 (20x20)	200			2
	250			2
	300			2
	400			2
	450			2

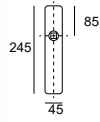

Ref.	INOX	NE	
SV-MP32			2

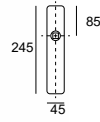

Ref.	INOX	NE	
SV-PP32			2



Ref.	INOX	NE	
SV-LP30			2



Ref.	mm	INOX	
SV-MF32	170x170		2



Ref.	mm	INOX	
SV-LF30	170x170		5

MANILLONES GRAN FORMATO



NEW

Ref.	A (B)	INOX	
EQ-M861 ■ 25 x 25 mm Desplazado 45°	400 (210)		1
	500 (300)		1
	600 (400)		1
	700 (500)		1
	800 (600)		1
	1200 (900)		1

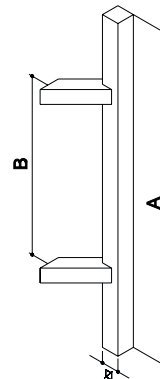



JANDEL INOX



NEW

Ref.	A (B)	INOX	
EQ-M851 40 x 10 mm	400 (210)		1
	500 (300)		1
	600 (400)		1
	800 (600)		1
	1200 (900)		1
	1500 (1300)		1

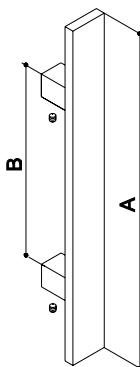

MANILLONES GRAN FORMATO



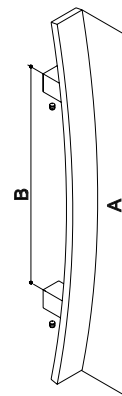

NEW

Ref.	A (B)	INOX	
EQ-M841 40 x 10 mm	500 (300)		1
	600 (400)		1
	800 (600)		1





Ref.	mm (entre cent.)	INOX	
EQ-M800 (Ø30)	300 (210)		2
	400 (300)		2
	500 (300)		2
	600 (400)		2
	800 (600)		2
	1200 (900)		2
	1500 (1300)		1
	1800 (1500)		1

Ref.	mm (entre cent.)	INOX	
EQ-M810 (Ø30) Desplazado 45°	300 (210)		2
	400 (300)		2
	500 (300)		2
	600 (400)		2
	800 (600)		2
	1200 (900)		2

Ref.	mm (entre cent.)	INOX	
EQ-M831 (■ 25)	300 (210)		2
	400 (300)		2
	500 (300)		2
	600 (400)		2
	800 (600)		2
	1200 (900)		2
	1500 (1300)		1
	1800 (1500)		1

* Medidas especiales consultar con el departamento comercial



Ref.	mm (entre cent.)	INOX	
EQ-M801 (Ø 25)	425 (400)		2
	625 (600)		2

Ref.	mm (entre cent.)	INOX	
EQ-M802 (Ø 25)	225 (200)		2
	325 (300)		2
	625 (600)		2
	925 (900)		2
	1225 (1200)		2

Ref.	mm (entre cent.)	INOX	
EQ-M802K (■ 25)	225 (200)		2
	325 (300)		2
	625 (600)		2
	925 (900)		2
	1225 (1200)		2



Ref.	mm	INOX	
SV-340	Ø 35		1



Ref.	mm	INOX	PVLM	
SV-345	Ø 50			1



Ref.	mm	INOX	
SV-B309	Ø 35		20



Ref.	mm	INOX	
SV-348	Ø 50		1



Ref.	mm	INOX	NE	PVLM	
SV-B304	Ø 50				20



Ref.	mm	INOX	NE	
SV-B305	Ø 50			20



Ref.	mm	INOX	
SV-B307	Ø 50		20



Ref.	mm	INOX	
SV-346	35 x 35		1



Ref.	mm	INOX	
SV-347	50 x 50		1



Ref.	mm	INOX	NE	
SV-B303	50 x 50			20



Ref.	mm	INOX	NE	
SV-B308	50 x 50			20



Ref.	mm	INOX	NE	
SV-B306	60 x 32			20



Ref.	INOX	
SV-1198		20



Ref.	mm	INOX	
HUELLA15	15 x 26		25



Ref.	mm	INOX	
HUELLA20	20 x 28		25



Ref.	mm	INOX	
TOPE INOX	22x30		25

JANDEL INOX





Ref.	mm	INOX	
SV-8510	Ø56 (Ø48 interior)		1





Ref.	mm	INOX	
SV-8610	Ø56 (Ø48 interior)		1



Ref.	mm	INOX	NE		
SV-170P	70 x 70			1	48



Ref.	mm	INOX		
SV-172P	Ø 85		1	48

JANDEL INOX



Ref.	mm	CB	CM	NM	BL	NE
M04A	45X20					



Ref.	mm	CM	NM
M27A	25X25	0.90	1.17



Ref.	mm	CM	NM
M26A	34X30		
M26B	25X21		



Ref.	mm	CM	NM
M28A	Ø 32	2.29	2.62

Ref.	mm	CM	NM
M03A	192		



Ref.	mm	CM	NM
M07A	128		



Ref.	mm	CB	CM	NM
M09A	128			
M09B	96			



Ref.	mm	CM	NM	NE
M10A	192			
M10B	128			



Ref.	mm	CM	NM
M12A	192		
M12B	160		
M12C	128		



Ref.	mm	CM	NM
M11A	192		
M11B	128		



Ref.	mm	CM	NM	BL	NE
M13A	240				
M13B	160				
M13C	128				



Ref.	mm	CM	NM
M14A	320		
M14B	224		
M14C	128		
M14D	96		
M14E	64		



Ref.	mm	CM	NM
M22A	256		
M22B	160		
M22C	128		



Ref.	mm	NM
M23A	792 / Ø12	
M23B	692 / Ø12	
M23C	592 / Ø12	
M23D	492 / Ø12	
M23E	442 / Ø12	
M23F	392 / Ø12	
M23G	342 / Ø12	
M23H	292 / Ø12	
M23I	242 / Ø12	
M23J	192 / Ø12	
M23K	160 / Ø12	
M23L	128 / Ø12	
M23M	96 / Ø12	



Ref.	mm	CM	NM
M24A	128		
M24B	96		
M24C	64		



Ref.	mm	CM	NM
M25A	128		



Ref.	mm	CM	NM
M29A	128		



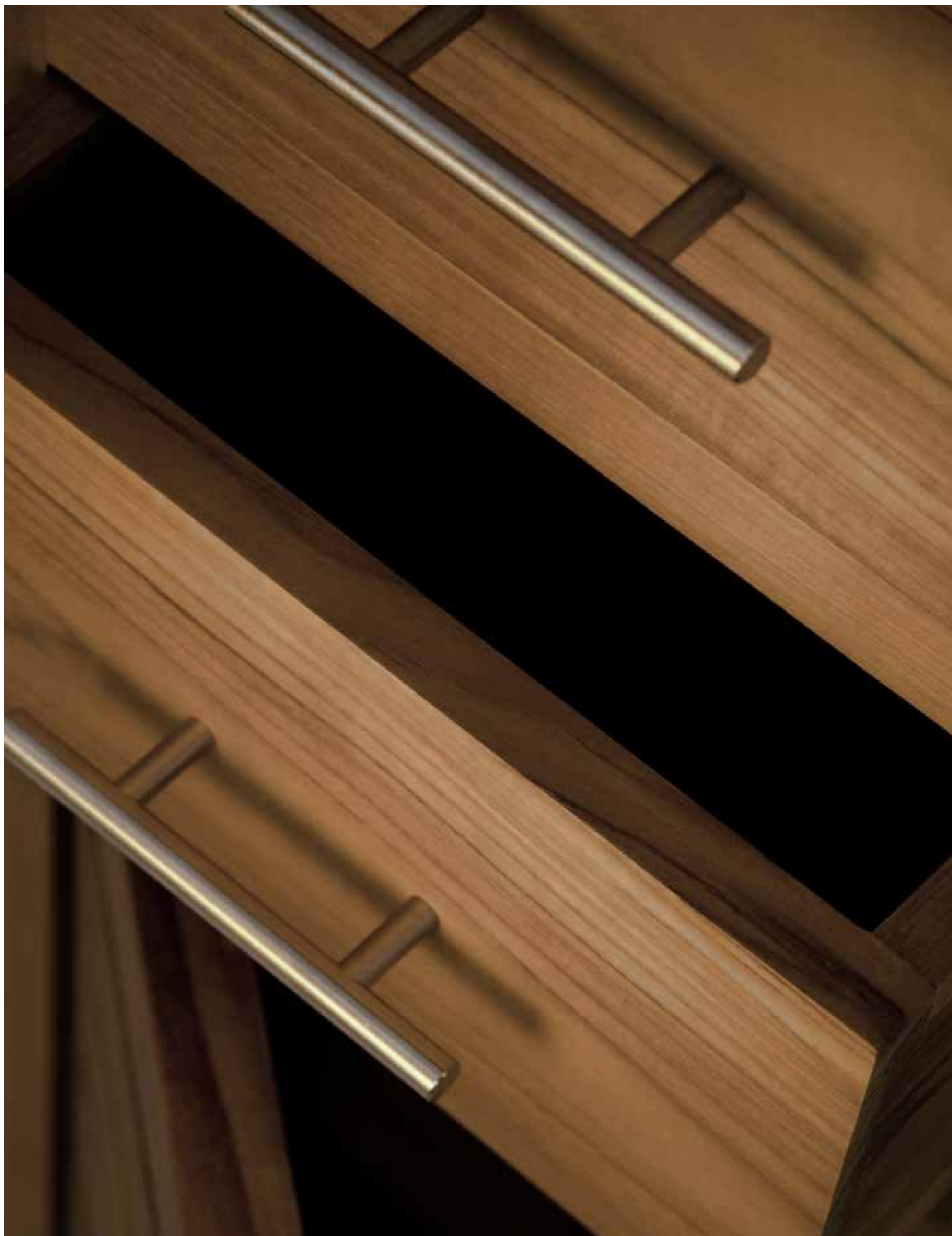



Ref.	mm	CU	CM
H55A	34x28		
H55B	22x22		



Ref.	mm	CU	CB	CM
H95A	47x47			
H95B	37x37			



Ref.	mm	CU	CM
H76A	24x21		



Ref.	mm	CU	CB	CM	PL
H102A	37x37				



Ref.	mm	CU	CM	PL
H93A	37x26			
H93B	25x18			



Ref.	mm	CU	CB	CM	PL
H103A	23x23				



Ref.	mm	CU	CM	PL
H94A	96			

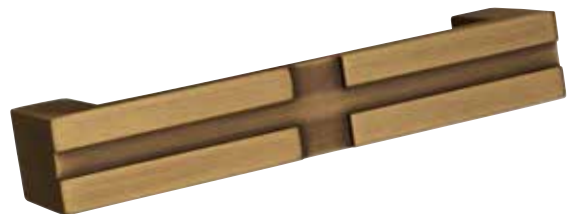

Ref.	mm	CU	PL
H113A	128		





Ref.	mm	CU	CB	CM	PL
H107A	Ø41 (32 entre centros)				



Ref.	mm	CU	CB	CM	PL
H115A	140x28 (96 entre centros)				



Ref.	mm	CU	CB	CM	PL
H108A	Ø78 (64 entre centros)				



Ref.	mm	CU	PL
H120A	96		



Ref.	mm	CU	CB	CM	PL
H111A	96				



Ref.	mm	CU	PL
H121A	50x50		



Ref.	mm	CU	CB	CM	PL
H112A	64				



Ref.	mm	CU	PL
H122A	35x35		



Ref.	mm	CU	CB	CM	PL
H123A	Ø62				



Ref.	mm	CU	CB	CM	PL
H124A	Ø50				



Ref.	mm	CU	CB	CM	PL
H125A	Ø28				





Ref.	mm	CU	PL
H126	50x50		



Ref.	mm	CU	PL
H127	35x35		



Ref.	mm	CU	PL
H128	22x22		





Ref.	mm	CU	PL
H129	68x68		



Ref.	mm	CU	CB	PL
H132	58x58			



Ref.	mm	CU	PL
H130	50x50		



Ref.	mm	CU	CB	PL
H133	45x45			



Ref.	mm	CU	PL
H131	40x40		



Ref.	mm	CU	CB	PL
H134	37x37			



Ref.	mm	CU	CB	PL
H135	28x28			



Ref.	mm	CM
H136	250 (128 entre centros)	



Ref.	mm	CM
H137	180 (128 entre centros)	

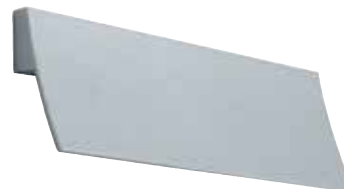

Ref.	mm	CM
H138	110 (64 entre centros)	



Ref.	mm	CB	CM
H140	64 (entre centros)		



Ref.	mm	NS
SV-HUELLA	Ø20	

Leyenda de acabados



PB Pulido Brillo



LM Latón Mate



EFLM Efecto Latón Mate



CU Cuero



CI Cuero Inglés



PS Pulido Satinado



NM Níquel Mate



CB Cromo Brillo



CS Cromo Satinado



PL Plata



CC Cromo Combinado



EFCS Efecto Cromo Satinado



ANTR Antracita



NM.OP Níquel Mate Opaco



CO.ST Cobre Satinado



AN Anticato



MR Marrón



NMM Níquel Mate Mate



NS Níquel Satinado



NS/NB Níq. Satín./Níq. Brillo



INOX



NE Negro



BL Blanco



PVLM PVD Latón Mate



PL. AN Plata Anodizada

¡ Hasta pronto !

www.jandel.es