

ESTAMP[®]
High quality handles

ESTAMP

ESTAMP[®]
High quality handles

Herrajes para muebles / Garnitures pour meubles / Furniture fittings / Möbelbeschläge

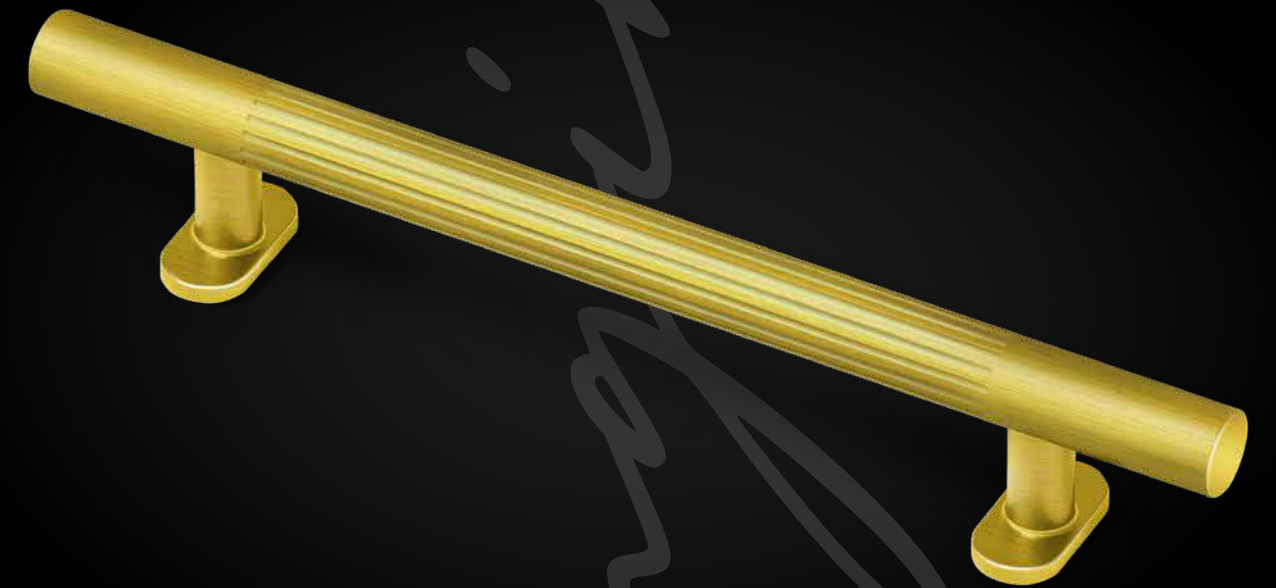

H I G H L I G H T S

J. JOSÉ VERGÉS S.A.
1 9 2 8

J. JOSÉ VERGÉS S.A.

Avda. de Cornellá, 140 bajos
Edificio LEKLA
08950 Esplugues de Llobregat
Barcelona - Spain

Tel. Nacional 933 713 954*

Fax Nacional 933 725 302

International Tel. 34 933 713 958*

International Fax 34 933 725 302

Email: estamp@verges.com

www.verges.com



J. JOSÉ VERGÉS S.A.
1 9 2 8

ESTAMP[®]
High quality handles

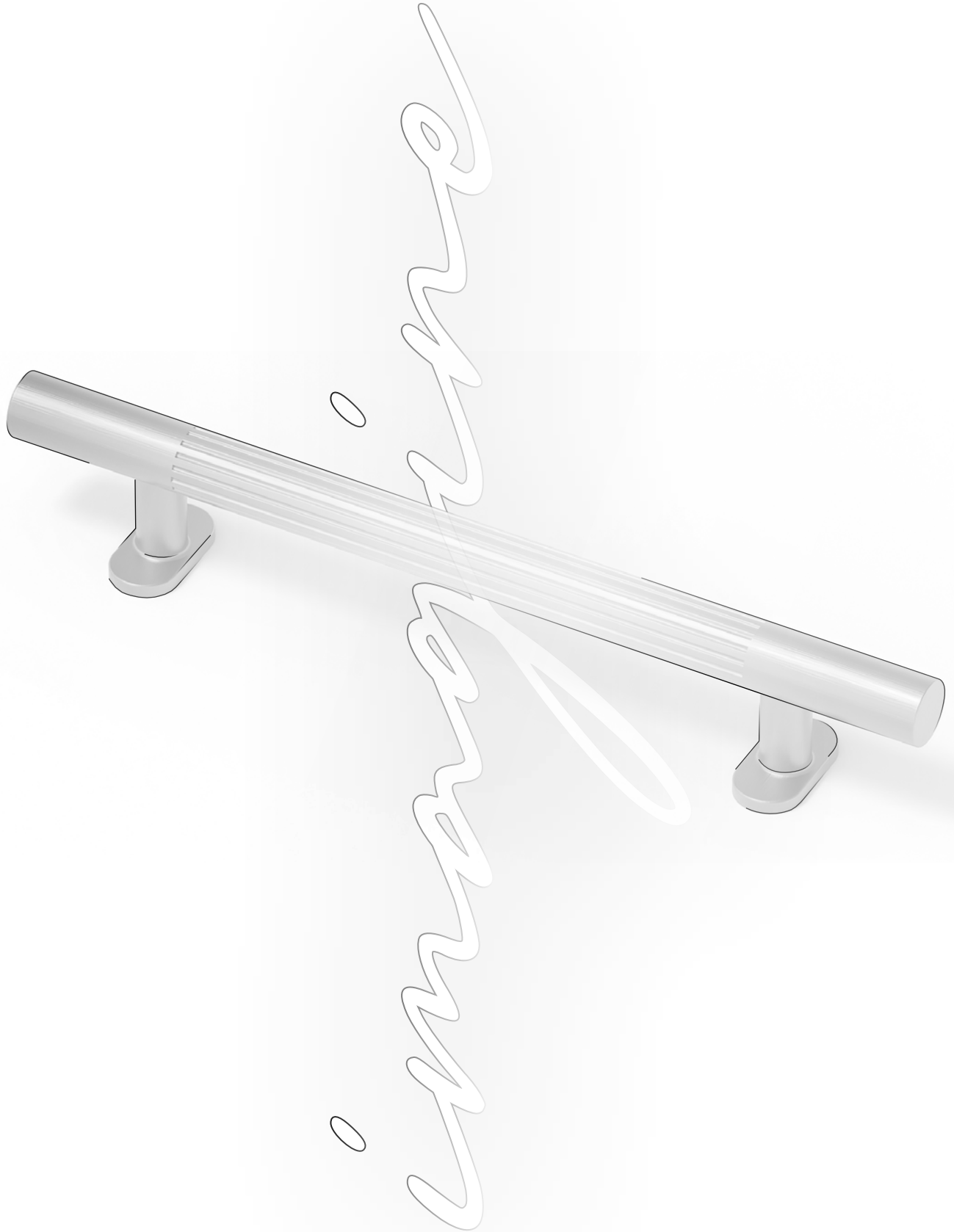

J. JOSÉ VERGÉS S.A.
1 9 2 8

Índice de referencias

Index de références

Index of references

Verzeichnis der Referenzen

1801	56	6240	32	6763	58	6841	30	6880	14	8161	54	9401	18
1802	56	6241	32	6764	58	6842	30	6881	14	8162	54	9402	18
1803	56	6242	32	6765	58	6843	30	6882	14	8171	54	9403	18
2880	64	6601	22	6781	50	6851	34	6883	14	8172	54	9404	18
3541	62	6602	22	6782	50	6852	34	6884	14	8181	28	9405	18
3542	62	6603	22	6791	52	6853	34	6891	26	8182	28	9411	16
3760	40	6604	22	6792	52	6860	38	6892	26	8341	30	9412	16
3770	40	6611	24	6811	48	6861	38	6893	26	8342	30	9413	16
3780	40	6612	24	6812	48	6862	38	7661	60	8891	26	9414	16
3790	40	6613	24	6821	44	6863	38	7662	60	8892	26		
3961	36	6614	24	6822	44	6871	28	7663	60	9011	20		
6210	46	6761	58	6831	42	6872	28	8151	54	9012	20		
6211	46	6762	58	6832	42	6873	28	8152	54	9400	18		



© J.José Vergés S.A., 2022

Avda. de Cornellá, 140 bajos
Edificio LEKLA
08950 Esplugues de Llobregat
Barcelona - Spain
Tel. Nacional 933 713 954*
Fax Nacional 933 725 302
International Tel. 34 933 713 958*
International Fax 34 933 725 302
Email: estamp@verges.com
www.verges.com

Los acabados mostrados en este catálogo son aproximados e ilustrativos y pueden variar ligeramente del color real.

Les finitions montrées dans ce catalogue sont approximées et illustratives et elles peuvent varier légèrement de la couleur réelle.

The finishes displayed in this catalogue are approximate and illustrative and may vary slightly from the actual colour.

Die in diesem Katalog gezeigten Oberflächen sind ungefähre Angaben und können von der tatsächlichen Farbe abweichen.

95 años de continua evolución

95 ans de continue évolution

95 years in constant evolution

95 Jahre kontinuierlicher Evolution

En Estamp cumplimos 95 años. Casi un siglo en el que hemos fabricado y vendido millones de artículos en todo el mundo.

Nada de esto hubiera sido posible sin la inestimable cooperación de todos y cada uno de nuestros colaboradores, dentro y fuera de nuestra empresa. Tampoco sin la creatividad y el acierto de nuestros diseñadores y la colaboración de nuestros proveedores. Es por eso que hoy queremos agradecer a todos ellos que nos hayan acompañado durante este largo viaje, e invitarles a que sigan haciéndolo durante muchos más.

Chez Estamp, nous avons 95 ans. Presque un siècle dans lequel nous avons fabriqué et vendu millions d'articles dans le monde entier.

Rien de cela aurait été possible sans l'inestimable coopération de tous et chacun de nos collaborateurs, dans et hors de notre entreprise. Aussi sans la créativité et le succès de nos designers et avec la collaboration de nos fournisseurs. C'est pour cela qu'aujourd'hui nous voulons remercier à tous ceux qui nous ont accompagnés pendant ce long voyage et les inviter à continuer de le faire pendant beaucoup plus.

At Estamp we celebrate our 95th birthday. Nearly a century during which we have manufactured and sold millions of articles worldwide.

This would not have been possible without the valuable co-operation of each and every one of our teammates, inside and outside our company. Nor without the creativity and the success of our designers and the co-operation of our suppliers. So today we wish to thank them all for walking beside us during this long journey, and to invite them to go on doing so for many more years to come.

Bei Estamp feiern wir 95 jähriges Jubiläum. Fast ein Jahrhundert, in dem wir Millionen Artikel hergestellt und weltweit verkauft haben.

All dies wäre nicht möglich gewesen ohne die unschätzbare Zusammenarbeit mit jedem einzelnen Mitarbeiter, innerhalb und außerhalb unseres Unternehmens, und überdies der Kreativität und dem Geschick unserer Designer sowie der Beteiligung unserer Lieferanten. Deshalb möchten wir uns heute bei allen bedanken, die uns auf dieser langen Reise begleitet haben und Sie einladen, dies noch für viele weitere Jahre zu tun.



Calidad y perfección Qualité et perfection Quality and perfection Qualität und Perfektion

La calidad y perfección siempre han sido nuestra divisa y la clave de nuestro éxito, por eso la hemos hecho extensiva a todos nuestros ámbitos de actividad, tanto de producción como humanos.

La qualité et la perfection ont été toujours notre devise et la clé de notre succès, pour cela nous l'avons étendu à tous nos cadres d'activité tant en production comme humains.

Quality and perfection have always been our trademark and the key to our success. This is why we have extended them to all our areas of activity, as much in production as in human resources.

Qualität und Perfektion sind seit jeher unser Motto und der Schlüssel unseres Erfolges. Aus diesem Grund haben wir es auf alle Tätigkeitsbereiche ausgedehnt, sowohl in der Produktion als auch das Personal betreffend.



Spheres



Empeño en la perfección
L'Effort de la perfection
 Endeavor for perfection
 Das Bekenntnis zur Perfektion



Tecnología, Experiencia y Talento
Technologie, Expérience et Talent
 Technology, Expertise and Talent
 Technologie, Erfahrung und Talent

Tres elementos imprescindibles para concebir y producir más de 1.500 artículos de formas puras de alta calidad y acabados perfectos.
Trois éléments indispensables pour concevoir et produire plus de 1.500 articles de formes pures de haute qualité et de finitions parfaites.
 Three essential elements to conceive and produce more than 1.500 articles in pure forms of high quality and perfect finishes.
Drei wesentliche Elemente zur Schaffung und Herstellung von mehr als 1.500 Artikeln reiner Formen in hoher Qualität und mit perfekten Oberflächen.



Diseño creativo

Design créatif
Creative design
Kreatives Design



Swing
Balutto Associati



Balutto Associati



ProFit
Josep J. Teruel



Grooves
Ramón Segarra



Ramón Segarra



Josep J. Teruel

Creando tendencias

En créant des tendances
Creating trends
Trends setzen

Afamados y experimentados diseñadores, innovan día a día para crear piezas únicas y nuevas colecciones.

Renommés et expérimentés designers innoverent jour à jour pour créer de pièces uniques et de nouvelles collections.

Renowned and experienced designers innovate every day to create unique pieces and new collections.

Renommierter und erfahrene Designer innovieren Tag für Tag, um einzigartige Stücke und neue Kollektionen zu kreieren.



Laps
Jorge Navarro



Jorge Navarro

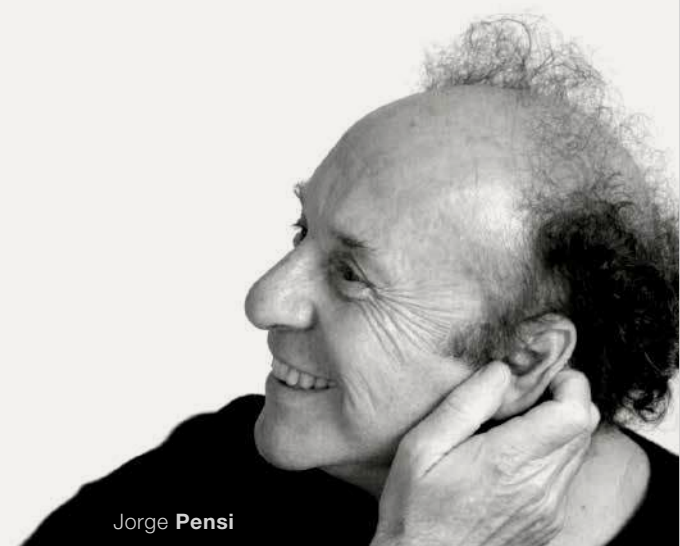

Jorge Pensi



Circle
Jorge Pensi Design Studio

imagine

El medio ambiente: nuestro compromiso

L'environnement : notre objectif

Environment is our aim

Umweltschutz: unser Ziel

En Estamp estamos plenamente comprometidos con la conservación del medio ambiente y es por eso que fuimos de las primeras empresas de nuestro sector en obtener la certificación ISO 14001 que nos acredita como fabricantes que utilizan procesos productivos no contaminantes y es también por eso que nos aseguramos que nuestros productos se fabriquen utilizando materiales que, como en el caso de la madera, permitan la sostenibilidad de los recursos naturales de nuestro planeta.

Chez Estamp, nous sommes pleinement engagés dans la préservation de l'environnement et pour cette raison, nous avons été l'une des premières entreprises de notre secteur à obtenir la certification ISO 14001 qui nous accrédite comme fabricants qui utilisent des processus de production non polluants. Nous veillons à ce que nos produits soient fabriqués en utilisant des matériaux qui, comme dans le cas du bois, permettent la durabilité des ressources naturelles de notre planète.

At Estamp we are fully committed to environmental sustainability and this is the reason why we were among the first companies in our sector to obtain the ISO 14001 certification that attests us as manufacturers using non-polluting production processes. This is also why we ensure that our products are manufactured using materials that, as in the case of wood, allow for the sustainability of our planet's natural resources.

Bei Estamp setzen wir uns voll und ganz für den Umweltschutz ein. Deshalb haben wir als eines der ersten Unternehmen unserer Branche die ISO 14001-Zertifizierung erhalten, die uns als Hersteller mit umweltfreundlichen Produktionsprozessen ausweist. Wir achten darauf, dass unsere Produkte aus Materialien wie beispielsweise Holz hergestellt werden, die Nachhaltigkeitsanforderungen erfüllen.

Protegiendo nuestro mundo

En protégeant notre monde

Protecting our world

Schutz unserer Umwelt

Expertos en fabricar con la mejor calidad y el máximo respeto al medioambiente.

Experts dans la fabrication avec la plus haute qualité et maximum de respect pour l'environnement.

Experts in manufacturing with the highest quality and maximum respect for the environment.

Experten bei der Herstellung in hochwertiger Qualität und maximalem Respekt für die Umwelt.



Conectados con nuestros clientes

Connecté avec nos clients

Connected with our clients

Verbunden mit unseren Kunden

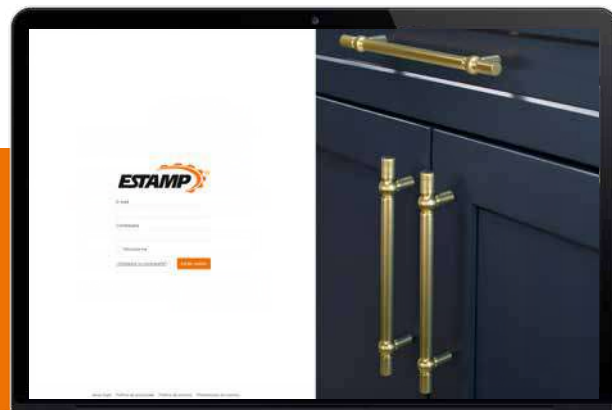

Descubra las últimas novedades
 Découvrez les dernières nouvelles
 Discover the latest news
 Entdecken Sie die neuesten Nachrichten
www.verges.com



Marketing y Merchandising

Marketing et Merchandising

Marketing and Merchandising

Marketing und Merchandising

En Estamp disponemos de un amplio equipo profesional dedicado al trato con el distribuidor para asesorarle de las mejores opciones comerciales para su punto de venta. Ponemos a su alcance una amplia variedad de herramientas que le ayudarán a conocer y, a la vez, dar a conocer mejor nuestros productos.

Chez Estamp, nous disposons d'une large équipe professionnelle dédiée au traitement avec le distributeur pour leur conseiller les meilleures options commerciales pour leur point de vente. Nous avons à leur disposition une vaste variété d'outils qui leur aideront à connaître et en même temps, donner à connaître mieux nos produits.

At Estamp we have a large professional team dedicated to deal with the distributor, to advise them of the best commercial options for their point of sale. We put at their disposal a wide variety of tools that will help you to know our product and, at the same time, make it better known.

Bei Estamp haben wir ein vielgestaltiges Team, das mit den Vertreibern in Verbindung steht. Es berät sie über die beste kommerzielle Option für Ihre Verkaufsabteilung. Ihnen steht eine breitgefächerte Vielfalt an Instrumenten zur Verfügung, die Ihnen helfen, unsere Produkte besser kennen zu lernen und gleichzeitig bekannter zu machen.



38,5 x 50 cm
 40 x 90 cm

49 x 201 cm



Fluted

Zamak

	B	C	D
6880	56	14	34

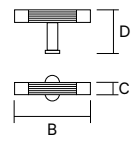

Fluted

Zamak

	A	E	B	C	D
6881	2 x 491	982	1040	14	34
6882	480		538	14	34
6883	320		378	14	34
6884	192		250	14	34

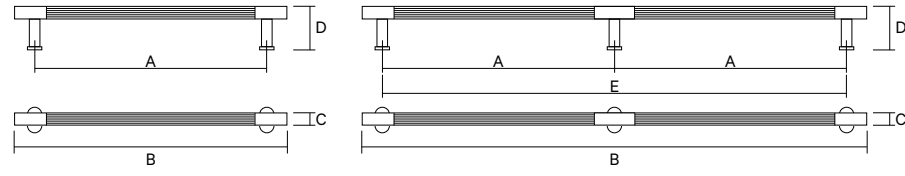

Acabado / Finition / Finish / Oberfläche



220

Oro cepillado anodizado
Or brossé anodisé
Brushed gold anodized
Goldfarben gebürstet eloxiert



232

Negro mate anodizado
Noir mat anodisé
Dull black anodized
Schwarz matt eloxiert



238

Níquel cepillado anodizado
Nickelé brossé anodisé
Brushed nickel anodized
Vernickelt gebürstet eloxiert



Otras longitudes disponibles bajo demanda y sujetas a cantidades mínimas a consultar.
Autres longueurs disponibles sur demande et sous réserve de quantités minimales à consulter.
Other lengths available and subject to minimum quantities on request.
Andere Längen auf Anfrage erhältlich, vorbehaltlich Mindestmengen.



Timber

Madera / Bois / Wood / Holz

	A	E	B	C	D
9411	3 x 352	1056	1110	24	12
9412	320		400	24	12
9413	192		250	24	12
9414	32		60	24	12

Acabado / Finition / Finish / Oberfläche



017

Arce barniz natural
Érable vernis naturel
Maple clear varnished
Ahorn klar lackiert



046

Arce barniz wengué
Érable vernis wengué
Maple wenge varnished
Ahorn wenge lackiert

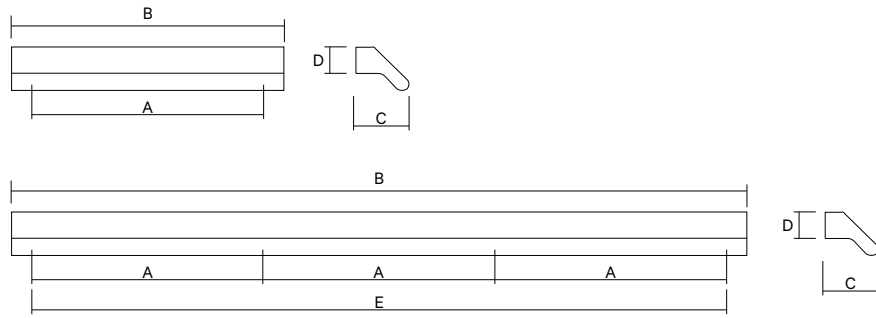

Round

Zamak - Madera / Bois / Wood / Holz

	B	C	D
9400	68	15	34

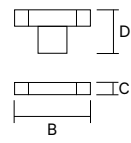

Round

Zamak - Madera / Bois / Wood / Holz

	A	E	B	C	D
9401	2 x 480	960	996	15	34
9402	480		516	15	34
9403	320		356	15	34
9404	192		228	15	34
9405	160		196	15	34

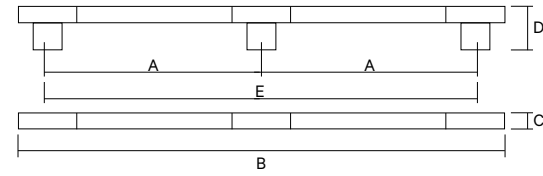
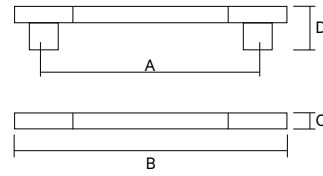

Acabado / Finition / Finish / Oberfläche



217

Oro cepillado arce barniz natural
Or brossé érable vernis naturel
Brushed gold, maple clear varnished
Goldfarben gebürstet, Ahorn klar lackiert



246

Oro cepillado arce barniz wengué
Or brossé érable vernis wengué
Brushed gold, maple wenge varnished
Goldfarben gebürstet, Ahorn wenge lackiert



317

Niquel cepillado arce barniz natural
Nickelé brossé érable vernis naturel
Brushed nickel, maple clear varnished
Vernickelt gebürstet, Ahorn klar lackiert



346

Niquel cepillado arce barniz wengué
Nickelé brossé érable vernis wengué
Brushed nickel, maple wenge varnished
Vernickelt gebürstet, Ahorn wenge lackiert



617

Negro mate arce barniz natural
Noir mat érable vernis naturel
Dull black, maple clear varnished
Schwarz matt, Ahorn klar lackiert



646

Negro mate arce barniz wengué
Noir mat érable vernis wengué
Dull black, maple wenge varnished
Schwarz matt, Ahorn wenge lackiert



Forest

Madera / Bois / Wood / Holz

	B	D	E
9011	38	28	18
9012	30	25	14

Acabado / Finition / Finish / Oberfläche



011

Madera barniz natural
Bois vernis naturel
Wood clear varnished
Holz klar lackiert



049

Madera barniz wengué
Bois vernis wengué
Wood wenge varnished
Holz wenge lackiert

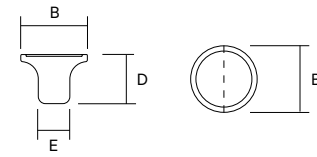

Slot

Aluminio / Aluminium / Aluminium / Aluminium

	A	E	B	C	D
6601	3 x 352	1056	1110	42	17
6602	320		400	42	17
6603	192		250	42	17
6604	32		50	42	17

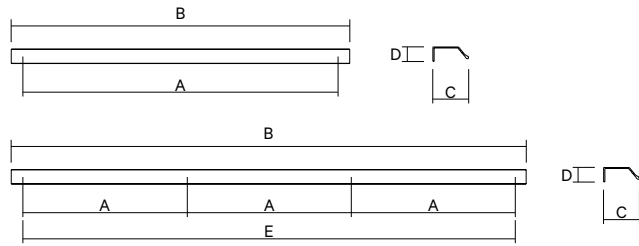

Acabado / Finition / Finish / Oberfläche



220

Oro cepillado anodizado
Or brossé anodisé
Brushed gold anodized
Goldfarben gebürstet eloxiert



232

Negro mate anodizado
Noir mat anodisé
Dull black anodized
Schwarz matt eloxiert



238

Níquel cepillado anodizado
Nickel brossé anodisé
Brushed nickel anodized
Vernickelt gebürstet eloxiert



Flat

Aluminio / Aluminium / Aluminium / Aluminium

	A	B	B	C	D
6611	3 x 352	1056	1110	40	17
6612	320		400	40	17
6613	192		250	40	17
6614	32		50	40	17

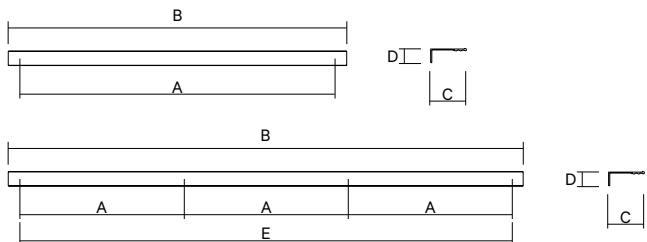

Acabado / Finition / Finish / Oberfläche



220

Oro cepillado anodizado
Or brossé anodisé
Brushed gold anodized
Goldfarben gebürstet eloxiert



232

Negro mate anodizado
Noir mat anodisé
Dull black anodized
Schwarz matt eloxiert



238

Níquel cepillado anodizado
Nickel brossé anodisé
Brushed nickel anodized
Vernickelt gebürstet eloxiert

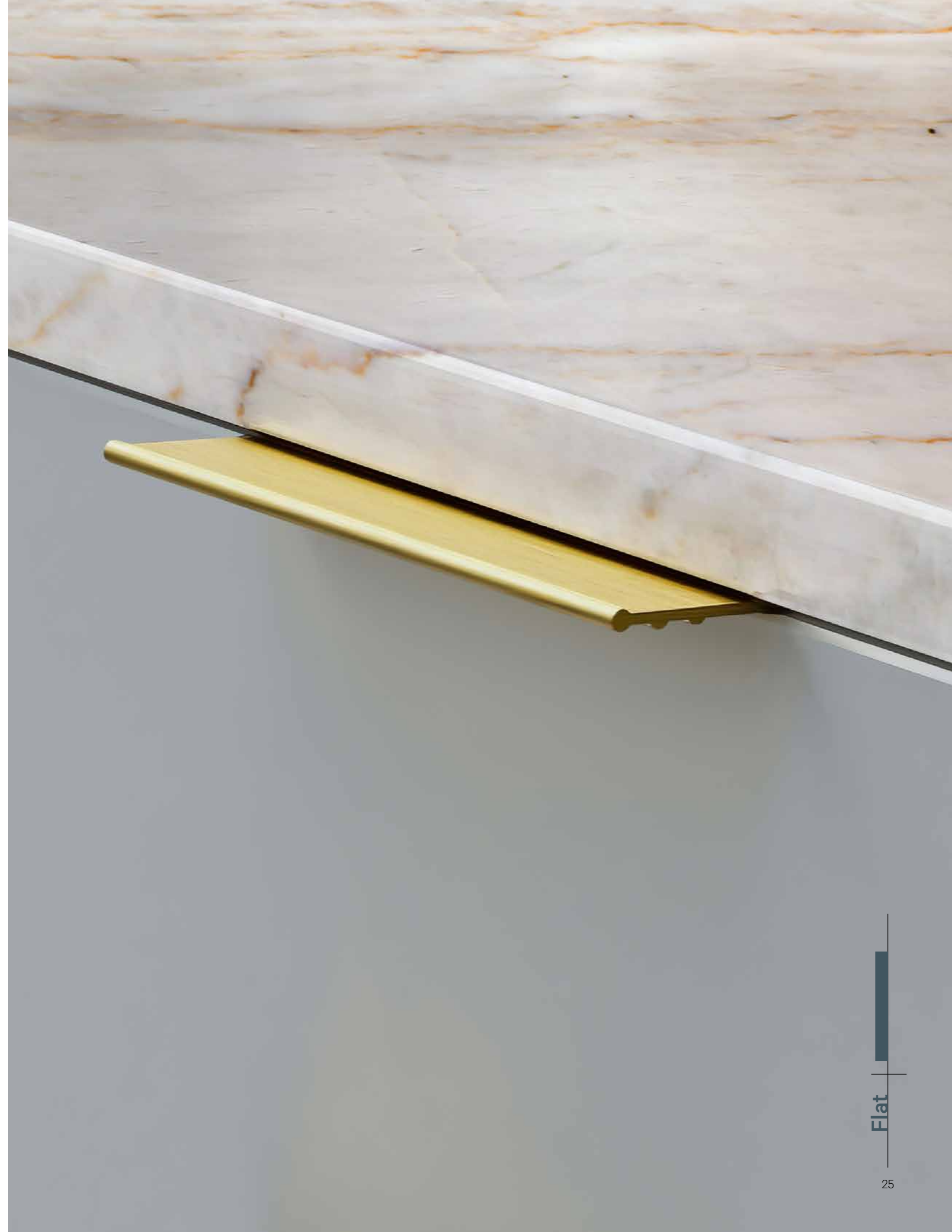

Mesh

Aluminio / Aluminium / Aluminium / Aluminium

	B	D	E
8891	36	28	20
8892	26	23	12

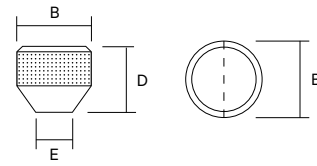

Mesh

Aluminio / Aluminium / Aluminium / Aluminium

	A	B	C	D
6891	320	332	12	29,5
6892	192	204	12	29,5
6893	160	172	12	29,5

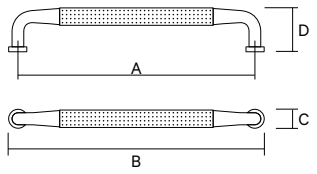

Acabado / Finition / Finish / Oberfläche



220

Oro cepillado anodizado
Or brossé anodisé
Brushed gold anodized
Goldfarben gebürstet eloxiert



232

Negro mate anodizado
Noir mat anodisé
Dull black anodized
Schwarz matt eloxiert



238

Níquel cepillado anodizado
Nickel brossé anodisé
Brushed nickel anodized
Vernickelt gebürstet eloxiert



Grooves

Zamak

	B	D
8181	28	30
8182	18	28

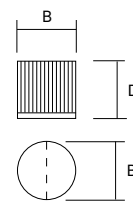

Grooves

Zamak

	A	B	C	D
6871	320	338	9	30
6872	192	210	9	30
6873	128	146	9	30

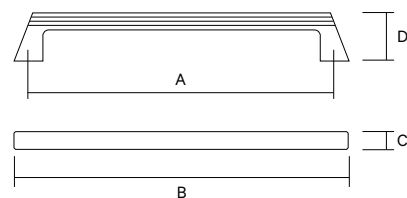

Acabado / Finition / Finish / Oberfläche



020

Oro cepillado
Or brossé
Brushed Gold
Gebürstetes Gold



032

Negro mate
Noir mat
Dull black
Mattschwarz



038

Níquel cepillado
Nickelé brossé
Brushed Nickel
Gebürstetes Nickel



400

Cromo brillo
Chromé brillant
Bright chrome
Glänzend verchromt



Disc

Zamak

	B	D	E
8341	33	25	15
8342	28	23	18

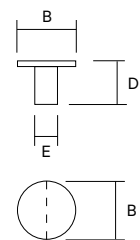

Right

Zamak

	A	B	C	D
6841	320	360	8	28
6842	192	232	8	28
6843	128	168	8	28

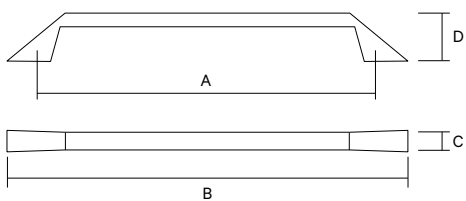

Acabado / Finition / Finish / Oberfläche



020
Oro cepillado
Or brossé
Brushed Gold
Gebürstetes Gold



032
Negro mate
Noir mat
Dull black
Mattschwarz



038
Níquel cepillado
Nickelé brossé
Brushed Nickel
Gebürstetes Nickel



292
Blanco mate
Blanc mat
Dull white
Matt Weiß



Swing

Zamak			
	B	C	D
6242	55	44	24

Swing

Zamak				
	A	B	C	D
6241	64	120	44	24

Swing

Zamak				
	A	B	C	D
6240	160	184	24	34

Acabado / Finition / Finish / Oberfläche

		
020 Oro cepillado Or brossé Brushed Gold Gebürstetes Gold	038 Níquel cepillado Nickelé brossé Brushed Nickel Gebürstetes Nickel	831 Bronze rústico Bronze rustique Antique brass Bronze rustikal

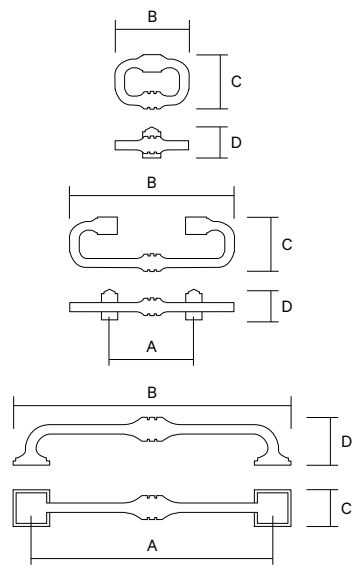

Wedge

Zamak

	A	B	C	D
6851	320	338	18	28
6852	192	210	18	28
6853	128	146	18	28

Acabado / Finition / Finish / Oberfläche



020

Oro cepillado
Or brossé
Brushed Gold
Gebürstetes Gold



032

Negro mate
Noir mat
Dull black
Mattschwarz



038

Níquel cepillado
Nickel brossé
Brushed Nickel
Gebürstetes Nickel



292

Blanco mate
Blanc mat
Dull white
Matt Weiß



Shell

Zamak

	A	B	C	D
3961	64	101	26	29

Acabado / Finition / Finish / Oberfläche



020

Oro cepillado
Or brossé
Brushed Gold
Gebürstetes Gold



032

Negro mate
Noir mat
Dull black
Mattschwarz



038

Níquel cepillado
Nickelé brossé
Brushed Nickel
Gebürstetes Nickel



400

Cromo brillo
Chromé brillant
Bright chrome
Glänzend verchromt

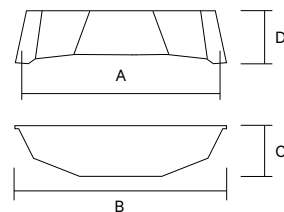

Spheres

Zamak

	B	C	D
6860	46	14	30

Spheres

Zamak

	A	B	C	D
6861	192	238	14	30
6862	128	174	14	30
6863	96	142	14	30

Acabado / Finition / Finish / Oberfläche



020
Oro cepillado
Or brossé
Brushed Gold
Gebürstetes Gold



032
Negro mate
Noir mat
Dull black
Mattschwarz



038
Níquel cepillado
Nickelé brossé
Brushed Nickel
Gebürstetes Nickel



831
Bronze rústico
Bronze rustique
Antique brass
Bronze rustikal

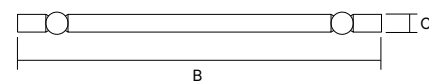
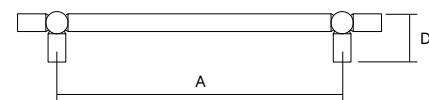
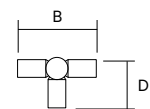

Round

Zamak				
	D	E	F	
3760	70	45	11	

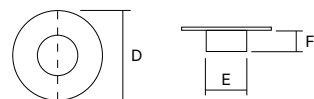

Square

Zamak				
	B	C	E	F
3770	73	73	45	11

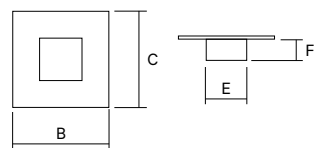

Oval

Zamak				
	B	C	E	F
3780	155	70	40x123	11

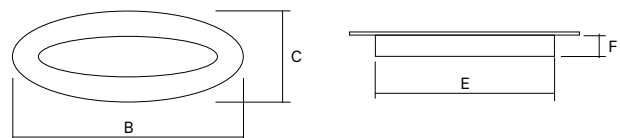

Rectangular

Zamak				
	B	C	E	F
3790	155	73	40x123	11

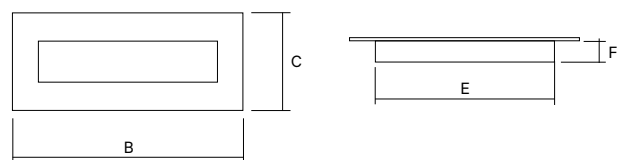

Acabado / Finition / Finish / Oberfläche



032
Negro mate
Noir mat
Dull black
Mattschwarz



038
Niquel cepillado
Nickelé brossé
Brushed Nickel
Gebürstetes Nickel



292
Blanco mate
Blanc mat
Dull white
Matt Weiß



400
Cromo brillo
Chromé brillant
Bright chrome
Glänzend verchromt









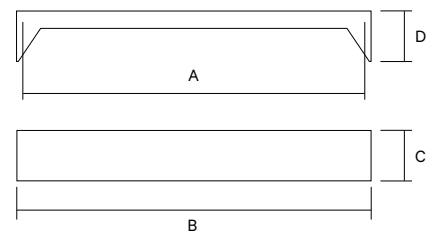

Post

Zamak

	A	B	C	D
6831	192	213	31	20
6832	128	149	31	20



Acabado / Finition / Finish / Oberfläche

		
020 Oro cepillado Or brossé Brushed Gold Gebürstetes Gold	032 Negro mate Noir mat Dull black Mattschwarz	038 Níquel cepillado Nickelé brossé Brushed Nickel Gebürstetes Nickel
		
250 Oro mate Or mat Dull gold Matt Gold	292 Blanco mate Blanc mat Dull white Matt Weiß	400 Cromo brillo Chromé brillant Bright chrome Glänzend verchromt
		
750 Grafito Graphite Graphite Graphit	800 Cromo mate Chromé mat Dull chrome Matt verchromt	







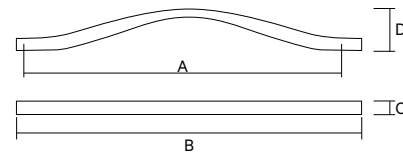



Fluid

Zamak				
	A	B	C	C
6821	320/288	363	7,60/12,80	33,80
6822	224/192	263	7,60/12,80	28,80



Acabado / Finition / Finish / Oberfläche

			
020 Oro cepillado Or brossé Brushed Gold Gebürstetes Gold	032 Negro mate Noir mat Dull black Mattschwarz	038 Níquel cepillado Nickelé brossé Brushed Nickel Gebürstetes Nickel	250 Oro mate Or mat Dull gold Matt Gold
			
292 Blanco mate Blanc mat Dull white Matt Weiß	400 Cromo brillo Chromé brillant Bright chrome Glänzend verchromt	750 Grafito Graphite Graphite Graphit	800 Cromo mate Chromé mat Dull chrome Matt verchromt

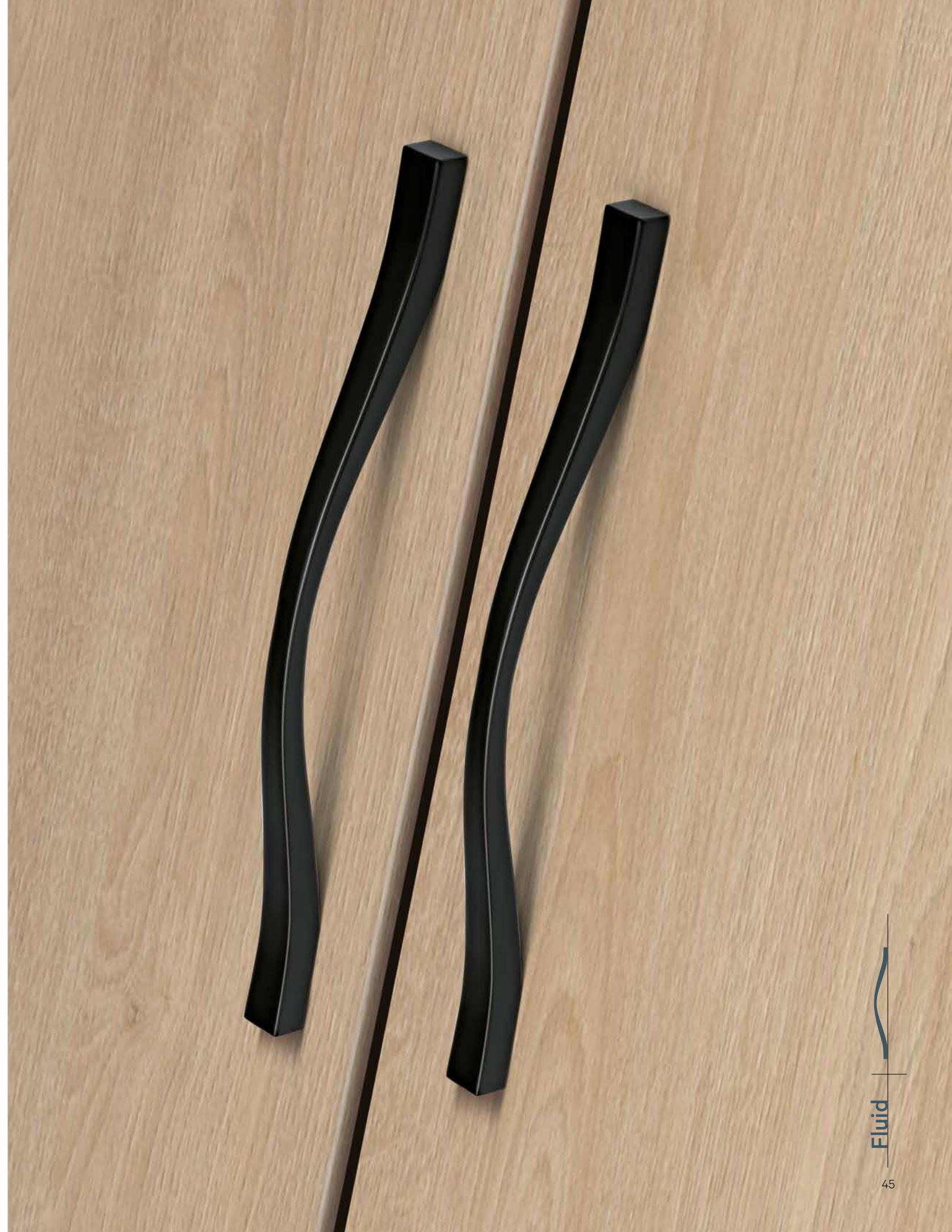

Rivet

Zamak

	A	B	C	D
6211	160	186	22	28

Acabado / Finition / Finish / Oberfläche



811

Bronze Industrial
Bronze industriel
Industrial Bronze
Bronze industriell



812

Hierro Industrial
Fer industriel
Industrial Iron
Eisen industriell

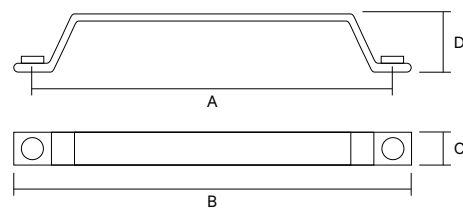

Rivet

Zamak

	B	C	D
6210	56	20	30

Acabado / Finition / Finish / Oberfläche



811

Bronze Industrial
Bronze industriel
Industrial Bronze
Bronze industriell



812

Hierro Industrial
Fer industriel
Industrial Iron
Eisen industriell

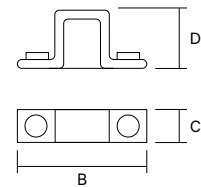

Fuji

Zamak

	A	B	C	D
6811	224	320	20	32
6812	160	230	20	32

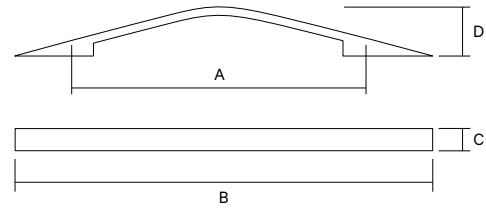

Acabado / Finition / Finish / Oberfläche

					
020 Oro cepillado Or brossé Brushed Gold Gebürstetes Gold	032 Negro mate Noir mat Dull black Mattschwarz	038 Níquel cepillado Nickelé brossé Brushed Nickel Gebürstetes Nickel	250 Oro mate Or mat Dull gold Matt Gold	292 Blanco mate Blanc mat Dull white Matt Weiß	400 Cromo brillo Chromé brillant Bright chrome Glänzend verchromt
					
750 Grafito Graphite Graphit	800 Cromo mate Chromé mat Dull chrome Matt verchromt	808 Cobre rústico Cuivre rustique Rustic copper Kupfer rustikal	831 Bronce rústico Bronze rustique Antique brass Bronze rustikal	836 Estaño rústico Etain rustique Rustic tin Zinn rustikal	



Lips

Zamak

	A	B	C	D
6781	224	320	45	21
6782	160	240	45	21

Acabado / Finition / Finish / Oberfläche



032
Negro mate
Noir mat
Dull black
Mattschwarz



038
Níquel cepillado
Nickelé brossé
Brushed Nickel
Gebürstetes Nickel



292
Blanco mate
Blanc mat
Dull white
Matt Weiß



400
Cromo brillo
Chromé brillant
Bright chrome
Glänzend verchromt



800
Cromo mate
Chromé mat
Dull chrome
Matt verchromt



808
Cobre rústico
Cuivre rustique
Rustic copper
Kupfer rustikal



831
Bronce rústico
Bronze rustique
Antique brass
Bronze rustikal



836
Estaño rústico
Etain rustique
Rustic tin
Zinn rustikal

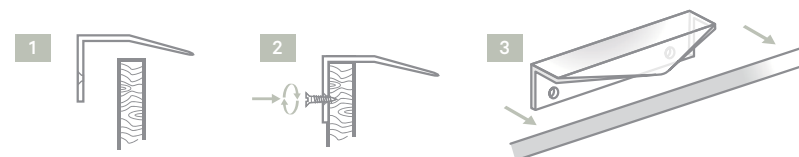
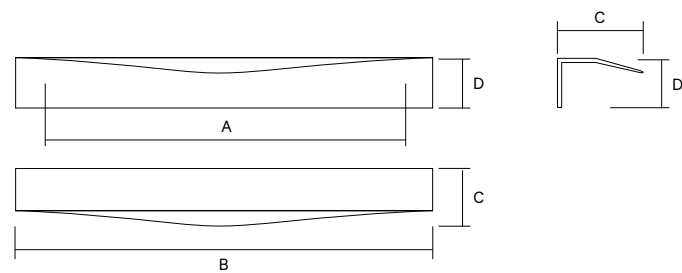

Grossor máximo frontal cajón: 24,5 mm
Grosseur maximale frontal tirair: 24,5 mm
Maximum width drawer front: 24,5 mm
Dicke maximal front schublade: 24,5 mm

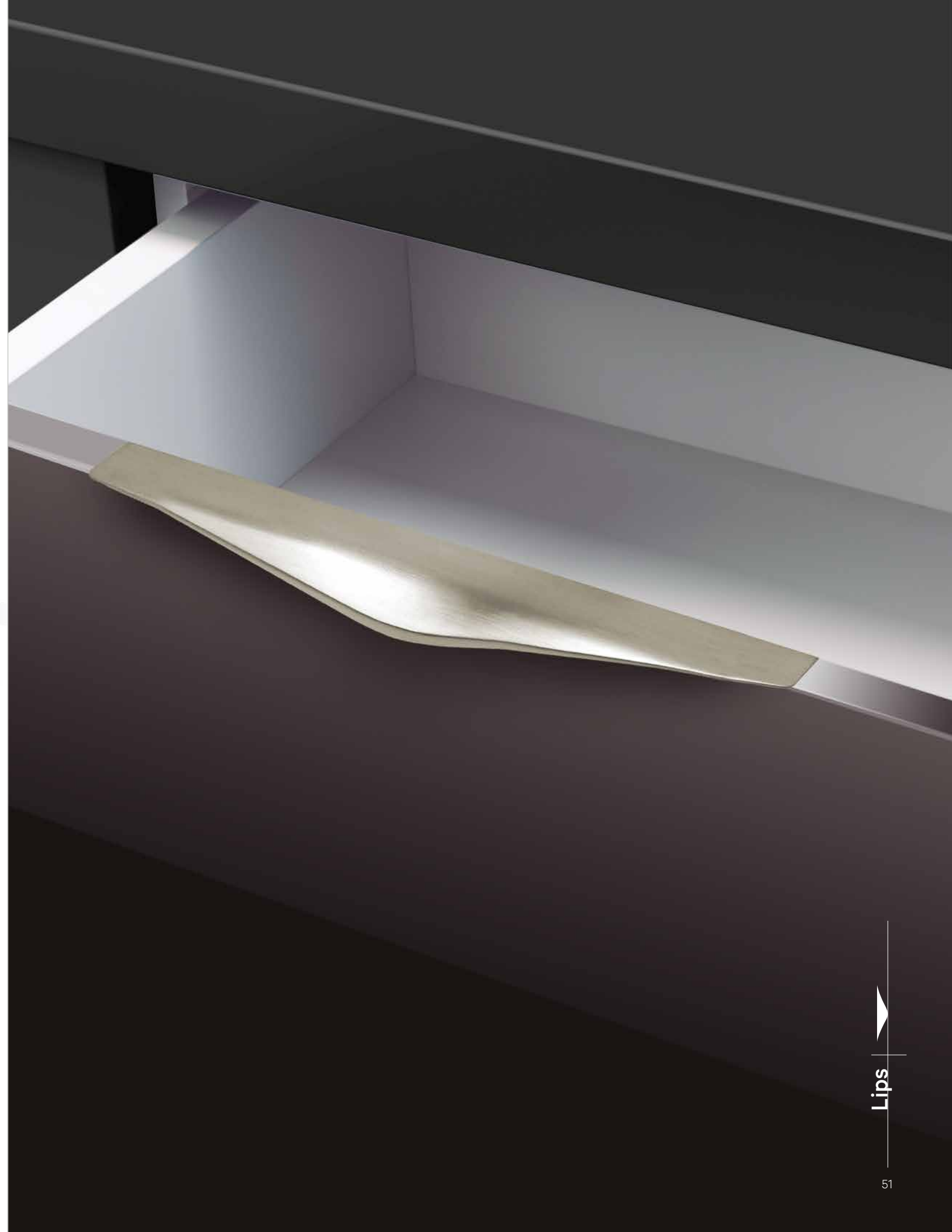
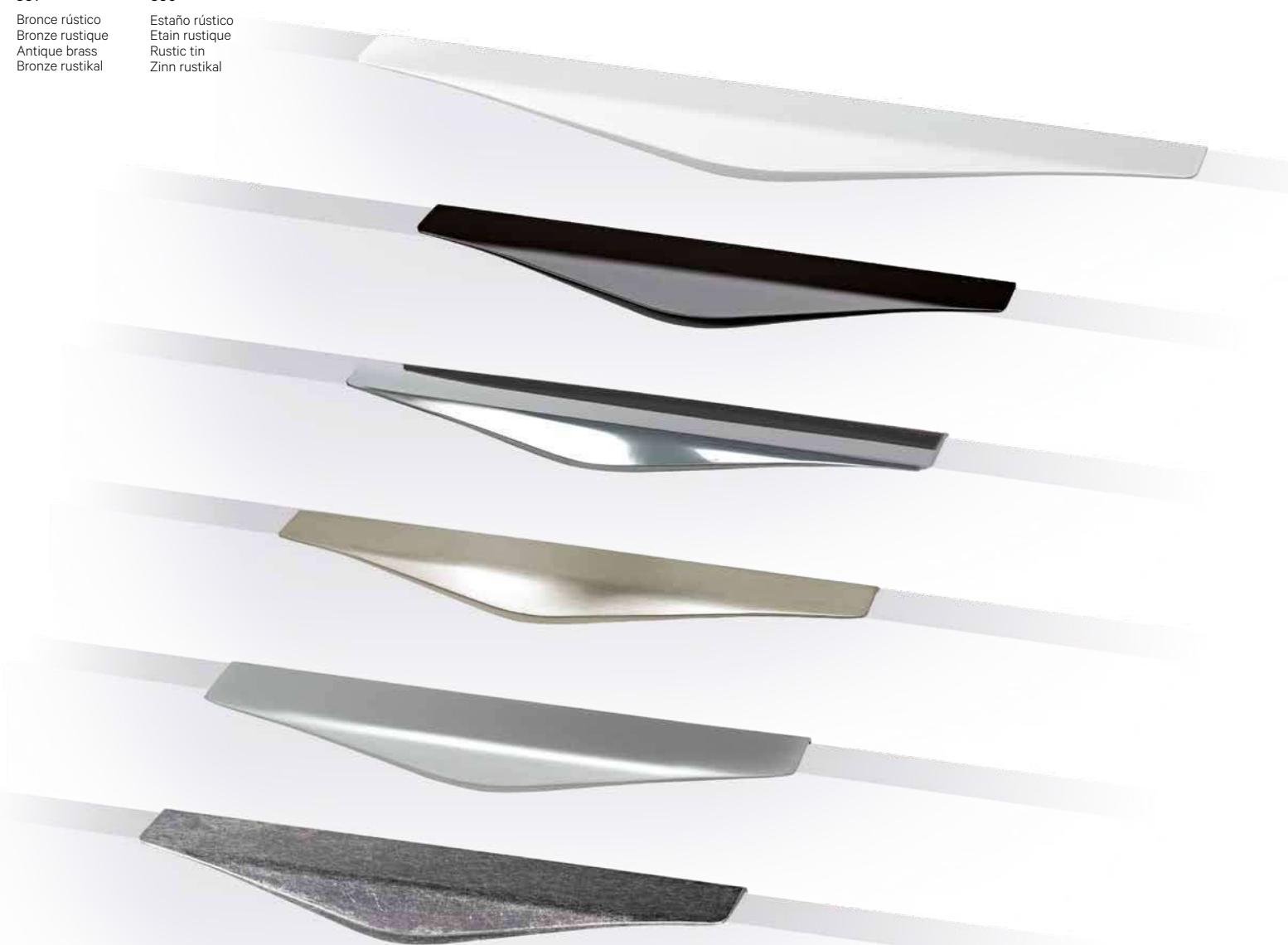

Arch

Zamak

	A	B	C	D
6791	192	270	20	20
6792	128	206	20	20

Acabado / Finition / Finish / Oberfläche



032
Negro mate
Noir mat
Dull black
Mattschwarz



038
Níquel cepillado
Nickelé brossé
Brushed Nickel
Gebürstetes Nickel



292
Blanco mate
Blanc mat
Dull white
Matt Weiß



800
Cromo mate
Chromé mat
Dull chrome
Matt verchromt

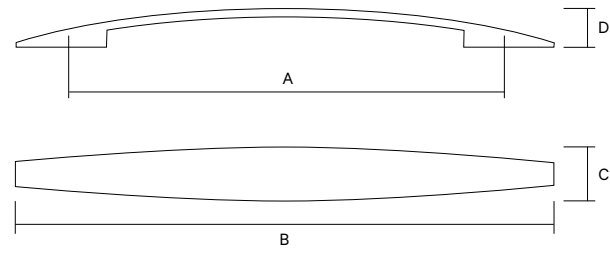

Mini

Zamak

	B	C	D
8151	25	25	28
8152	15	15	24

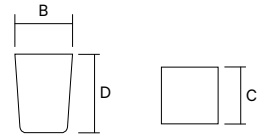

Acabado / Finition / Finish / Oberfläche

020 Oro cepillado Or brossé Brushed Gold Gebürstetes Gold	021 Aluminio Aluminium Aluminium Aluminium	038 Níquel cepillado Nickelé brossé Brushed Nickel Gebürstetes Nickel	250 Oro mate Or mat Dull gold Matt Gold

400 Cromo brillo Chromé brillant Bright chrome Glänzend verchromt	750 Grafito Graphite Graphite Graphit	800 Cromo mate Chromé mat Dull chrome Matt verchromt



Mini

Zamak

	B	D
8161	25	28
8162	15	24

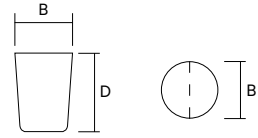

Acabado / Finition / Finish / Oberfläche

020 Oro cepillado Or brossé Brushed Gold Gebürstetes Gold	021 Aluminio Aluminium Aluminium Aluminium	032 Negro mate Noir mat Dull black Mattschwarz	038 Níquel cepillado Nickelé brossé Brushed Nickel Gebürstetes Nickel	250 Oro mate Or mat Dull gold Matt Gold

292 Blanco mate Blanc mat Dull white Matt Weiß	400 Cromo brillo Chromé brillant Bright chrome Glänzend verchromt	750 Grafito Graphite Graphite Graphit	800 Cromo mate Chromé mat Dull chrome Matt verchromt



Mini

Zamak

	B	C	D
8171	34	14	28
8172	27	11	24

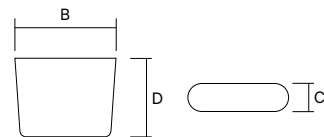

Acabado / Finition / Finish / Oberfläche

021 Aluminio Aluminium Aluminium Aluminium	032 Negro mate Noir mat Dull black Mattschwarz	038 Níquel cepillado Nickelé brossé Brushed Nickel Gebürstetes Nickel

292 Blanco mate Blanc mat Dull white Matt Weiß	400 Cromo brillo Chromé brillant Bright chrome Glänzend verchromt	800 Cromo mate Chromé mat Dull chrome Matt verchromt



Profit

Zamak

	A	B	C	D
1801	288/320	341	10	31
1802	192/224	245	10	31
1803	128/160	180	10	31

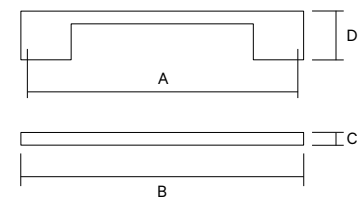

Acabado / Finition / Finish / Oberfläche



038

Níquel cepillado
Nickelé brossé
Brushed Nickel
Gebürstetes Nickel



800

Cromo mate
Chromé mat
Dull chrome
Matt verchromt

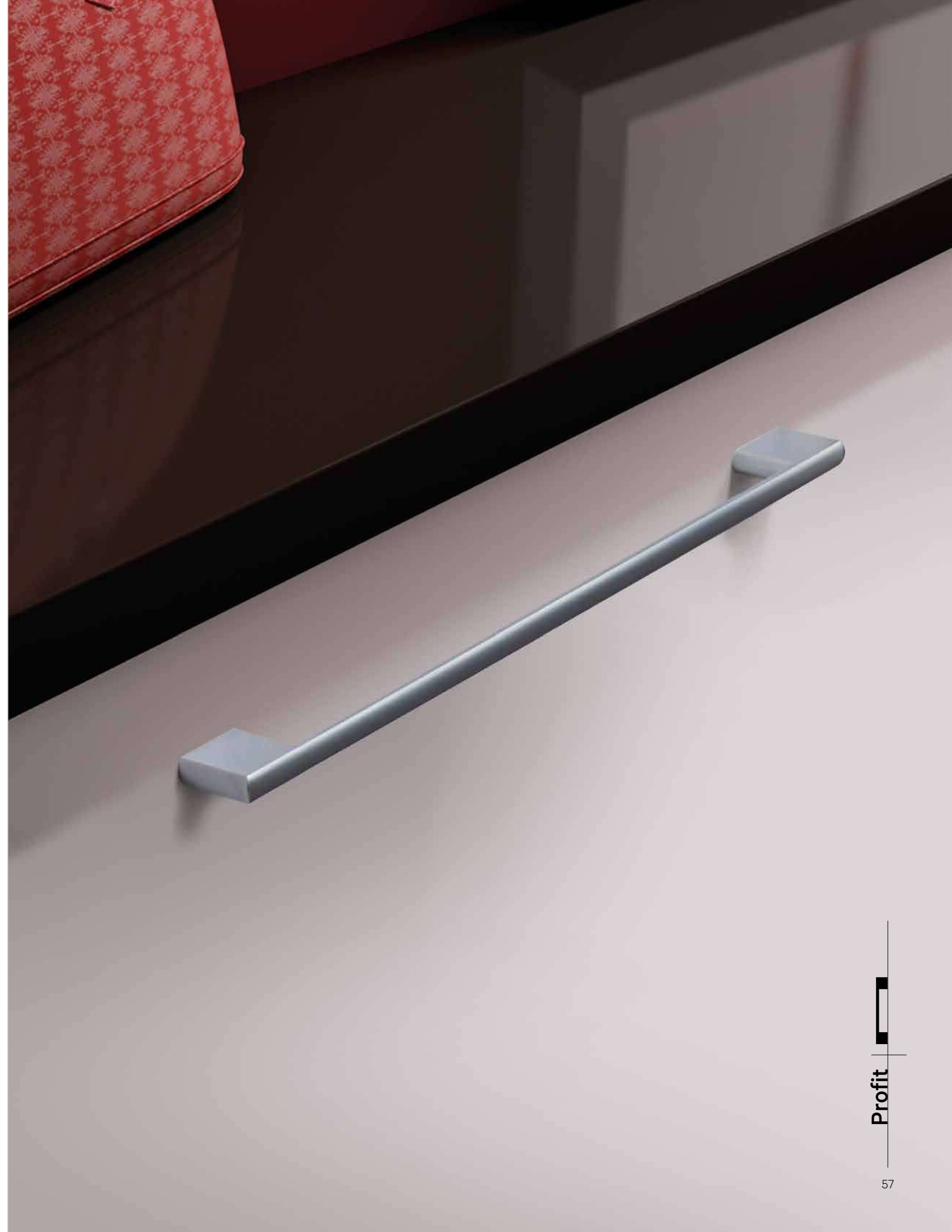







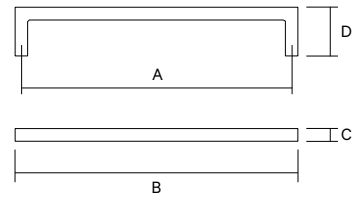



Basic

Zamak

	A	B	C	D
6761	320	328	8	28
6762	256	264	8	28
6763	192	200	8	28
6764	160	168	8	28
6765	128	136	8	28



Acabado / Finition / Finish / Oberfläche

				
020 Oro cepillado Or brossé Brushed Gold Gebürstetes Gold	032 Negro mate Noir mat Dull black Mattschwarz	038 Níquel cepillado Nickelé brossé Brushed Nickel Gebürstetes Nickel	250 Oro mate Or mat Dull gold Matt Gold	292 Blanco mate Blanc mat Dull white Matt Weiß
				
750 Grafito Graphite Graphit	800 Cromo mate Chromé mat Dull chrome Matt verchromt	808 Cobre rústico Cuivre rustique Rustic copper Kupfer rustikal	831 Bronce rústico Bronze rustique Antique brass Bronze rustikal	836 Estaño rústico Etain rustique Rustic tin Zinn rustikal



Synthesis

Zamak

	A	B	C	D
7661	192	230	44	24
7662	96	135	44	24
7663	32	71	44	24

Acabado / Finition / Finish / Oberfläche



021
Aluminio
Aluminium
Aluminium
Aluminium



032
Negro mate
Noir mat
Dull black
Mattschwarz



038
Niquel cepillado
Nickelé brossé
Brushed Nickel
Gebürstetes Nickel



292
Blanco mate
Blanc mat
Dull white
Matt Weiß



400
Cromo brillo
Chromé brillant
Bright chrome
Glänzend verchromt



800
Cromo mate
Chromé mat
Dull chrome
Matt verchromt



808
Cobre rústico
Cuivre rustique
Rustic copper
Kupfer rustikal



831
Bronce rústico
Bronze rustique
Antique brass
Bronze rustikal



836
Estaño rústico
Etain rustique
Rustic tin
Zinn rustikal

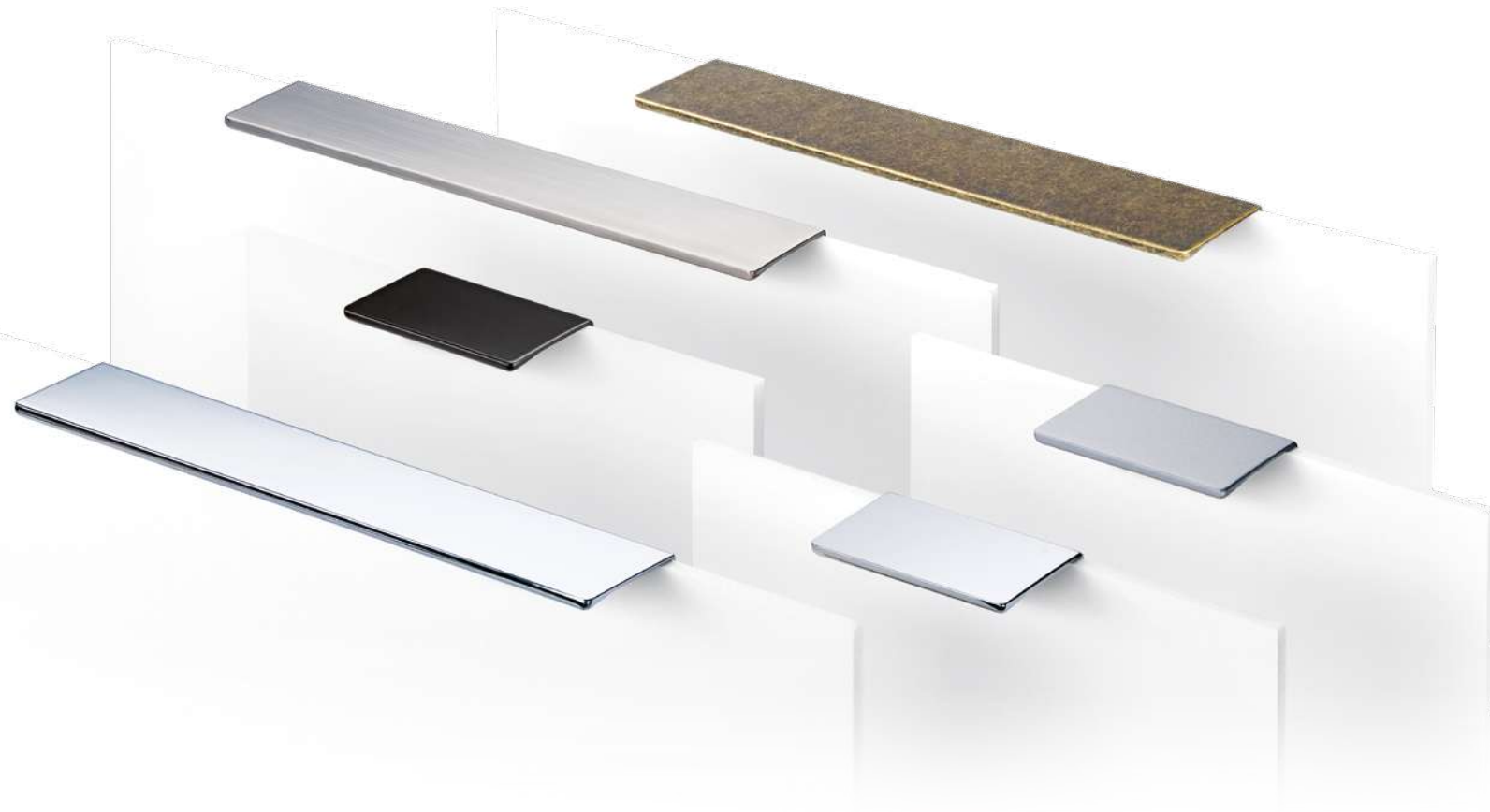
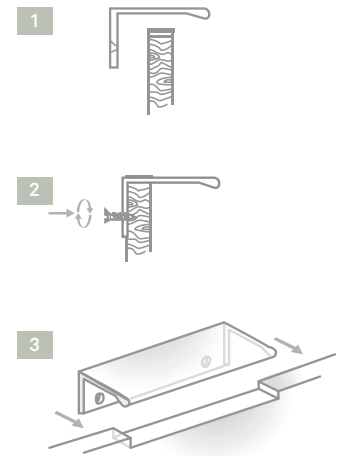
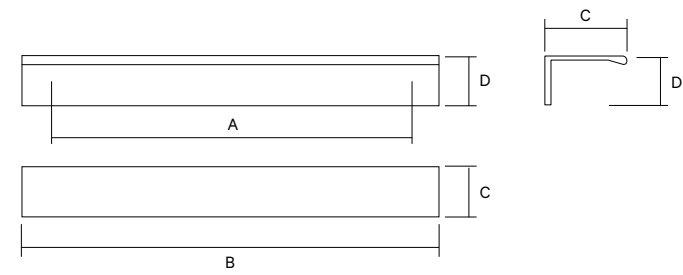

Slim

Zamak

	B	C	E	F
3541	240	25	235x20	10,7
3542	150	25	145x20	10,7

Acabado / Finition / Finish / Oberfläche



038

Níquel cepillado
Nickelé brossé
Brushed Nickel
Gebürstetes Nickel



800

Cromo mate
Chromé mat
Dull chrome
Matt verchromt

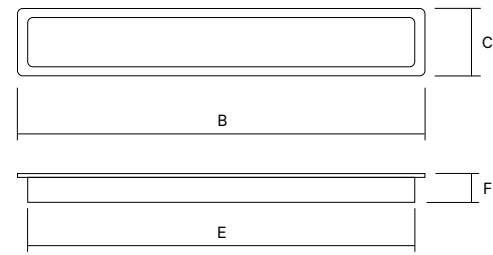

Diabolo

Zamak

	D	E
2880	35	60

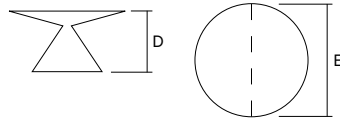

Acabado / Finition / Finish / Oberfläche



032
Negro mate
Noir mat
Dull black
Mattschwarz



038
Níquel cepillado
Nickelé brossé
Brushed Nickel
Gebürstetes Nickel



292
Blanco mate
Blanc mat
Dull white
Matt Weiß



400
Cromo brillo
Chromé brillant
Bright chrome
Glänzend verchromt



800
Cromo mate
Chromé mat
Dull chrome
Matt verchromt



831
Bronce rústico
Bronze rustique
Antique brass
Bronze rustikal



Notas

Remarques

Notes

Anmerkungen

Notas

Remarques

Notes

Anmerkungen