

inofix[®]

2024

Catálogo General
General Catalogue

[inofix.com](https://www.inofix.com)

Inofix diseña productos pensando en las personas.

Inofix designs products with people in mind.

Creemos que el diseño lo es todo, porque está en todo. Hasta en los objetos más cotidianos, que muchas veces pasan desapercibidos.

Queremos darle valor al diseño diario. El que observa el día a día de todas las personas, lo entiende y lo mejora.

El que da importancia a todos y cada uno de los detalles. Y el que busca el equilibrio perfecto entre la funcionalidad y la estética.

Para así, hacer que la vida de las personas sea un poco más sencilla, y además, un poco más bella.

We believe that design is everything, because it is in everything. Even in the most everyday objects, which often go unnoticed.

We want to give value to everyday design. The one who observes the day-to-day life of everybody, understands that and makes it better.

The one who gives importance to each and every one of the details. And the one looking for the perfect balance between functionality and aesthetics.

To make the life of people are a little simpler, and also, a little more beautiful.



Buscando el equilibrio entre lo útil y lo bello.

Seeking balance between
the useful and the beautiful.

Inofix
nace el año
was born in
1972

Desde entonces mantenemos la idea
inicial de fabricar y comercializar
productos de diseño propio en el sector
de la ferretería y bricolaje.

Since then, we have remained true to our
initial idea of manufacturing and
selling our own design products in the
hardware and DIY sector.





PRESENCIA INTERNACIONAL

La proyección hacia mercados exteriores ya es una realidad en los inicios de la empresa, pero es a partir del año 1986 que se apuesta por el crecimiento en esta dirección con la participación en ferias internacionales. Actualmente Inofix está presente en 35 países y en más de 15.000 puntos de venta.

INTERNATIONAL PRESENCE

The projection towards foreign markets is already a reality in the beginnings of the company, is from the year 1986 when it is committed to growth in this direction with participation in international fairs. Inofix is currently present in 35 countries and in more than 15,000 points of sale.



SOSTENIBILIDAD Y MEDIO AMBIENTE

Establecemos políticas sostenibles y procedimientos respetuosos con el medio ambiente. En 1998 se firma contrato con la organización Ecoembes para la Gestión Integral de Residuos. Posteriormente nos adherimos al Plan Sectorial de Prevención, donde la empresa se compromete a reducir progresivamente los envases de sus productos.

En el año 2013 Saint Genís S.A. obtiene los certificados PEFC y FSC con el objetivo de incentivar el cuidado y trato con el medio ambiente así como también el uso responsable de nuestros bosques. Con estos certificados garantizamos que la actividad de nuestra empresa se está desarrollando bajo criterios de sostenibilidad forestal.

Todos nuestros productos presentados en formatos blíster, están cambiando progresivamente de PVC a RPET. El material conocido como RPET (tereftalato de polietileno) es plástico PET 100% reciclado y 100% reciclable. Asimismo, todo el cartón utilizado en las cajas y presentaciones de nuestros productos cuenta con una certificación de 80% del material reciclado, mientras que en cajas de embalaje y cajas de envío la certificación es del 100%.

SUSTAINABILITY AND THE ENVIRONMENT

We have adopted sustainable policies and environmentally procedures. In 1998, we signed an agreement with Ecoembes, a not-for-profit organisation that devises integrated waste management systems. Subsequently, we signed up to a sector-based waste prevention plan, whereby the company made a commitment to gradually reduce the packaging of its products.

In 2013, Saint Genís, S.A. obtained the Pan European Forest Certification (PEFC) and FSC in order to encourage environmental protection, as well as the responsible use of our forests. By holding these certifications, we are able to guarantee that our company conducts its business according to sustainable forestry criteria.

All our products presented in formats blister packs, they are progressively switching from PVC to RPET. The material known as RPET (polyethylene terephthalate) is 100% recycled and 100% recyclable PET plastic. Also, all the cardboard used in the boxes and presentations of our products have a certification of 80% of the recycled material, while in packaging boxes and shipping boxes the certification is 100%.



DISEÑO E INNOVACIÓN

El desarrollo de nuestros propios diseños y nuevos conceptos de producto, a menudo patentados, nos permite diferenciarnos y posicionarnos en la mente del consumidor como marca de referencia en diseño y calidad. Apostamos por productos que aporten valor añadido, pensando más allá de la mera funcionalidad.

DESIGN AND INNOVATION

By developing our own designs and new concepts, most of which are patented, we have been able to set ourselves apart from the rest to become a leading brand of design and quality in the minds of consumers. We are committed to products that provide added value, thinking beyond mere functionality.

**CONTACTA CON NOSOTROS:
CONTACT WITH US:**

+34 93 684 26 57

info@inofix.com



1

COLGADORES
HOOKS



2

ACCESORIOS PARA PUERTAS Y VENTANAS
COMPLEMENTS FOR DOORS AND WINDOWS



3

ACCESORIOS PARA MUEBLES
FURNITURE COMPLEMENTS

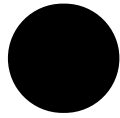

4

ELEMENTOS DE FIJACIÓN PARA CABLE ELÉCTRICO
ELECTRIC WIRE SUPPORTS



5

CINTAS Y ADHESIVOS
TAPES & ADHESIVES



6

SEGURIDAD INFANTIL EN EL HOGAR
CHILD SAFETY AT HOME



7

PROTECTORES PARA PARKING
PARKING LOT CAR PROTECTION

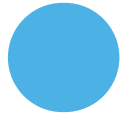

8

COMPLEMENTOS PARA EL HOGAR
HOME COMPLEMENTS



9

SOPORTE AL PUNTO DE VENTA
POINT OF SALE ASSISTANCE



i

TABLA DE INFORMACIÓN DE ARTÍCULOS
ARTICLE INFORMATION TABLE

COLGADORES

HOOKS

Colgadores “water resistant”
Water resistant hangers

6

Colgadores grandes
Large hangers

8

Colgadores pequeños
Small hooks

31

Sujetanotas
Note holder

45

Colgadores para
escobas y herramientas
Broom and tool hooks

46

Ventosas y Stick&Go!
Suction pads & Stick&Go!

49



Resistentes al agua

Water
resistant

water
resistant

**EUROPEAN
PRODUCT
DESIGN
AWARD**

2019 BRONZE PRIZE WINNER

INOFIX WATERPROOF SERIES



2190

AGUANTA
HOLDS

2,5 KG
5,5 LB

Colgador adhesivo resistente al agua "cinta".
Water resistant "Ribbon" adhesive hook.

Medidas producto
Product measures
65x65x45 mm.

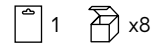

2192

AGUANTA
HOLDS

2 KG
4,4 LB

Colgador adhesivo resistente al agua "rama doble".
Water resistant "Double Branch" adhesive hook.

Medidas producto
Product measures
60x65x32 mm.

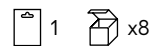

2191

AGUANTA
HOLDS

1,8 KG
4 LB

Colgador adhesivo resistente al agua "rama".
Water resistant "Branch" adhesive hook.

Medidas producto
Product measures
60x30x25 mm.

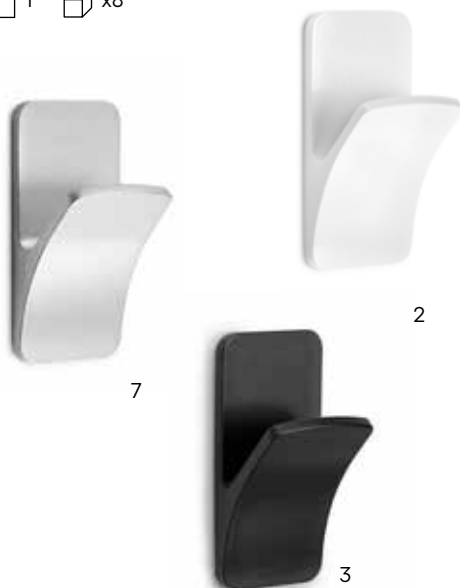

2193

AGUANTA
HOLDS

1,5 KG
3,3 LB

Colgador adhesivo resistente al agua "gota".
Water resistant "Raindrop" adhesive hook.

Medidas producto
Product measures
52x38x16 mm.

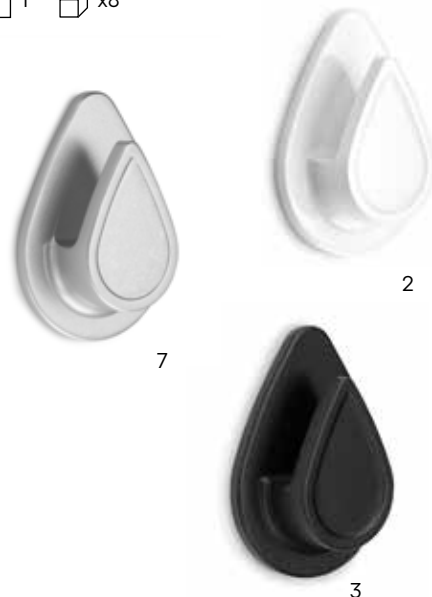
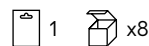



COLGADORES - COLGADORES GRANDES
HOOKS - LARGE HANGERS

80

3723

Colgador de madera de fresno NORDIK con 3 ganchos de metal. Fijación con tornillos (incluidos).
NORDIK ash wood hook rack with 3 metal hooks. Screw-fastening (screws included).

Medidas producto
Product measures
68x360x51mm.



3724

Colgador de madera de fresno NORDIK con 4 ganchos de metal. Fijación con tornillos (incluidos).
NORDIK ash wood hook rack with 4 metal hooks. Screw-fastening (screws included).

Medidas producto
Product measures
68x488x51mm.

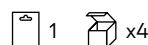

3743

Colgador de madera de fresno ONA con 3 ganchos de metal. Fijación con tornillos (incluidos).
ONA ash wood hook rack with 3 metal hooks. Screw-fastening (screws included).

Medidas producto
Product measures
60x360x55 mm.



3744

Colgador de madera de fresno ONA con 4 ganchos de metal. Fijación con tornillos (incluidos).
ONA ash wood hook rack with 3 metal hooks. Screw-fastening (screws included).

Medidas producto
Product measures
60x488x55 mm.





3702

Colgador de madera de haya con dos ganchos de metal. Fijación con tornillos (incluidos).
Two hook rack in beech wood. Screw-fastening (screws included).

Medidas producto
Product measures
60x231x60 mm.

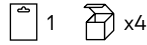

 **Tornillos** (incluidos)
Screws (included)



0



8



2



0



8



3

3703

Colgador de madera de haya con tres ganchos de metal. Fijación con tornillos (incluidos).
Three hook rack in beech wood. Screw-fastening (screws included).

Medidas producto
Product measures
60x360x60 mm.

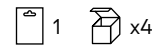

 **Tornillos** (incluidos)
Screws (included)



3704

Colgador de madera de haya con cuatro ganchos de metal. Fijación con tornillos (incluidos).
Four hook rack in beech wood. Screw-fastening (screws included).

Medidas producto
Product measures
60x490x60 mm.



 **Tornillos** (incluidos)
Screws (included)



2



0



8



3



3712

Colgador de madera de haya con dos pomos de metal. Fijación con tornillos (incluidos).
Two hook rack in beech wood. Screw-fastening (screws included).

Medidas producto
Product measures
60x231x60 mm.

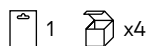

 **Tornillos** (incluidos)
Screws (included)



3713

Colgador de madera de haya con tres pomos de metal. Fijación con tornillos (incluidos).
Three hook rack in beech wood. Screw-fastening (screws included).

Medidas producto
Product measures
60x360x60 mm.

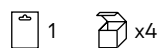

 **Tornillos** (incluidos)
Screws (included)



3714

Colgador de madera de haya con cuatro pomos de metal. Fijación con tornillos (incluidos).
Four hook rack in beech wood. Screw-fastening (screws included).

Medidas producto
Product measures
60x490x60 mm.

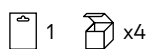

 **Tornillos** (incluidos)
Screws (included)





3731

Colgador individual de madera de fresno tintada con textura. Fijación con tornillos (incluidos).

Textured ash wood peg. Screw-fastening (screws included).

Medidas producto
Product measures
Ø40 x 45 mm.

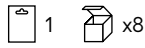

 **Tornillos** (incluidos)
Screws (included)

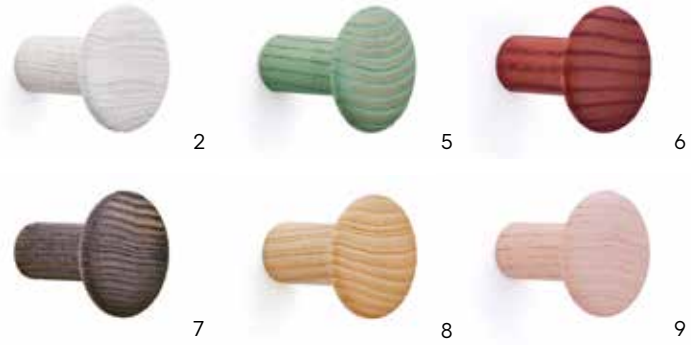

3733

Colgador tres pomos de madera de fresno tintada con textura. Fijación con tornillos (incluidos).

Textured ash wood peg 3 hooks. Screw-fastening (screws included).

Medidas producto
Product measures
60x360x60 mm.

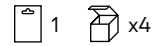

 **Tornillos** (incluidos)
Screws (included)





2



5



6



7



8



9

3734

Colgador cuatro pomos de madera de fresno tintada con textura. Fijación con tornillos (incluidos).

Textured ash wood peg 4 hooks. Screw-fastening (screws included).

Medidas producto
Product measures
60x488x60 mm.

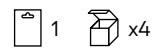

 **Tornillos** (incluidos)
Screws (included)



1471

AGUANTA
HOLDS

1KG
2.2 LB

Colgador adhesivo
hecho de madera.
Adhesive wooden hook.

Medidas producto
Product measures
44x65x54 mm.

1 x6

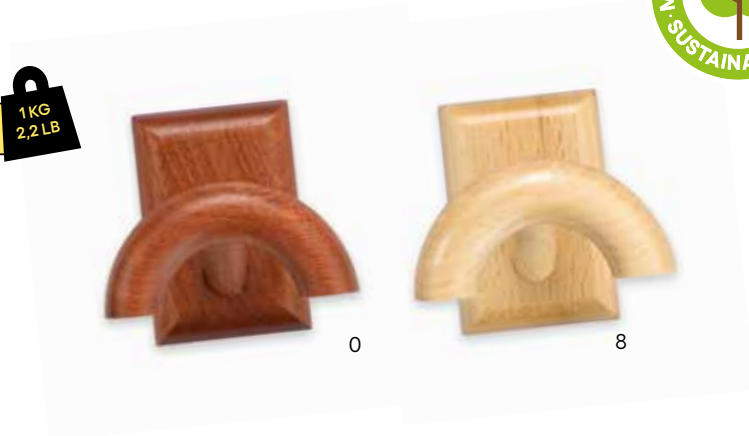

0



8

1472

Colgador de madera doble gancho.
Fijación con tornillos (incluidos).
Two hook rack in wood.
Screw-fastening (screws included).

Medidas producto
Product measures
44x245x53 mm.

1 x6

 **Tornillos** (incluidos)
Screws (included)



1473

Colgador de madera
triple gancho.
Fijación con tornillos
(incluidos).
Three hook rack
in wood.
Screw-fastening
(screws included).

Medidas producto
Product measures
44x385x53 mm.

1 x6

 **Tornillos** (incluidos)
Screws (included)



0



8







1481

AGUANTA
HOLDS

1 KG
2,2 LB

Colgador adhesivo
hecho de madera.
Adhesive wooden hook.

Medidas producto
Product measures
85x80x51 mm.



 1  x6



1482

Colgador de madera doble gancho.
Fijación con tornillos (incluidos).
Two hook rack in wood.
Screw-fastening (screws included).

Medidas producto
Product measures
50x245x51 mm.

 1  x6

 **Tornillos** (incluidos)
Screws (included)



1483

Colgador de madera
triple gancho.
Fijación con tornillos
(incluidos).
Three hook rack
in wood.
Screw-fastening
(screws included).

Medidas producto
Product measures
50x385x51 mm.

 1  x6

 **Tornillos** (incluidos)
Screws (included)





3771

Colgador de
madera de pino.
Fijación con tornillos
(incluidos).
Hook in pine wood.
Screw-fastening
(screws included).

Medidas producto
Product measures
Ø50x67 mm.

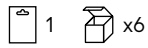

 **Tornillos** (incluidos)
Screws (included)



3773

Colgador triple de
madera de pino.
Fijación con tornillos
(incluidos).
Three hook rack
in pine wood.
Screw-fastening
(screws included).

Medidas producto
Product measures
50x360x71 mm.



 **Tornillos** (incluidos)
Screws (included)





N

3772

Colgador doble de madera de pino.

Fijación con tornillos (incluidos).

Two hook rack in pine wood. Screw-fastening (screws included).



2



8

Medidas producto

Product measures 50x232x71 mm.

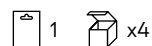

Tornillos (incluidos)
Screws (included)



9



0



2

3774

Colgador cuadruple de madera de pino.

Fijación con tornillos (incluidos).

Four hook rack in pine wood. Screw-fastening (screws included).



2



8

Medidas producto

Product measures 50x488x71 mm.

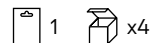

Tornillos (incluidos)
Screws (included)



9



0





A



B



C



D



F



H



M

3707

Colgador 5 ganchos
con base de madera
de pino pintada.

Fijación con tornillos
(incluidos).

Five hook rack with a painted
pine base. Screw-fastening
(screws included).

Medidas producto
Product measures
60x488x52 mm.

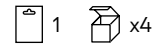

Diseños para los más pequeños

Fun designs for the younger members of the family.

2180

AGUANTA
HOLDS

2 KG
4,4 LB

Colgador adhesivo infantil.
Fijación opcional con tornillos (no incluidos).
Infantile adhesive hook.
Optional screw-fastening (screws not included).

Medidas producto
Product measures
Ø65x47 mm.

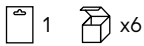

2180

SURTIDO ASSORTMENT
Disponemos de caja surtida para este producto.
Incluye colores 4-5-7-8-9.
Assorted boxes are available for this product.
Includes colours 4-5-7-8-9.



¡Detalles originales y divertidos!

Original and funny details!



3706

Colgador infantil 4 ganchos con base de madera pintada.
Fijación con tornillos (incluidos).
Kid's hanger with 4 hooks and painted wooden base.
Screw-fastening (screws included).

Medidas producto
Product measures
80x488x48 mm.

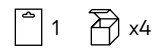

3706

SURTIDO ASSORTMENT
Disponemos de caja surtida para este producto.
Incluye colores A-B-C-D.
Assorted boxes are available for this product.
Includes colours A-B-C-D.

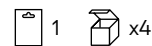

 **Tornillos** (incluidos)
Screws (included)

¡Nuevas propuestas de color!

New colour range!

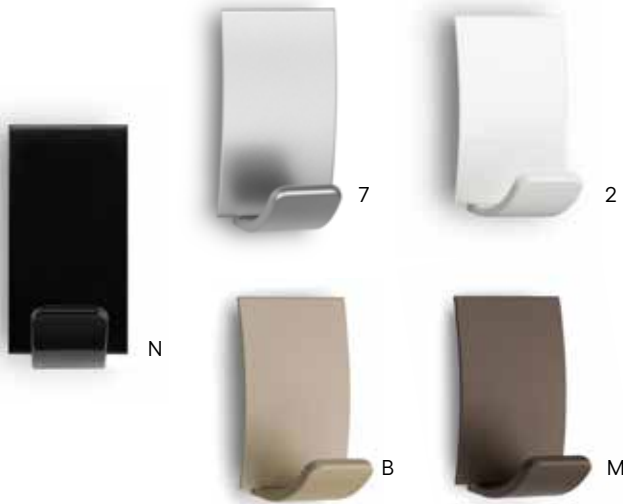

2312

AGUANTA
HOLDS

2 KG
4,4 LB

Colgador adhesivo.
Fijación opcional con tornillos (no incluidos).
Adhesive hook.
Optional screw-fastening (screws not included).

Medidas producto
Product measures
92x50x54 mm.

1 x6

3093

Colgador triple.
Fijación con tornillos (incluidos).
Three hook rack.
Screw-fastening (screws included).

Medidas producto
Product measures
50x384x46 mm

1 x5

 **Tornillos** (incluidos)
Screws (included)

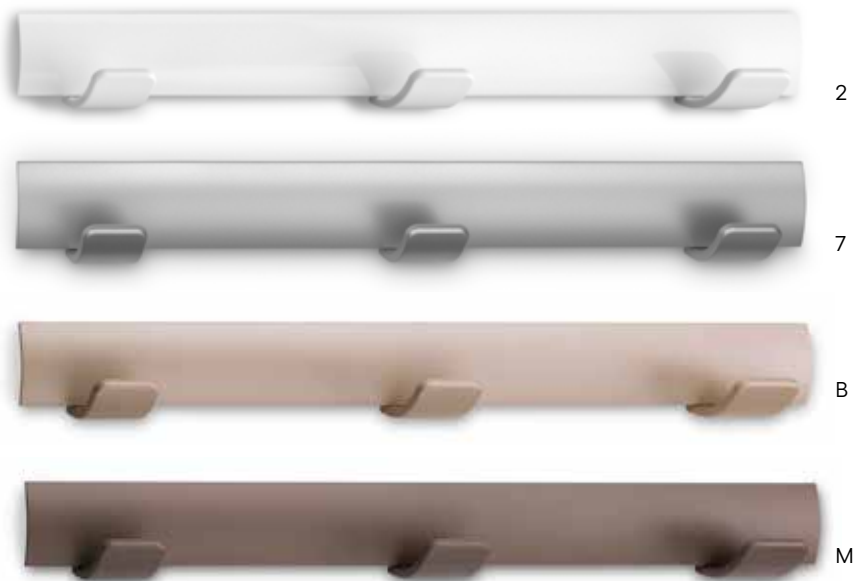



2086

AGUANTA
HOLDS

2 KG
4,4 LB

Colgador adhesivo.
Fijación opcional con
tornillos (no incluidos).
Adhesive hanger.
Optional screw-fastening
(screws not included).

Medidas producto
Product measures
68x60x53 mm.

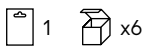

2088

AGUANTA
HOLDS

2 KG
4,4 LB

Colgador adhesivo.
Fijación opcional con
tornillos (no incluidos).
Adhesive hanger.
Optional screw-fastening
(screws not included).

Medidas producto
Product measures
107x30x52 mm.

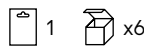



Con goma anti-deslizante.

With non-slip rubber.

3087

Colgador cilíndrico.
Fijación con tornillos
(incluidos).
Cylindrical hanger.
Screw-fastening
(screws included).

Medidas producto
Product measures
34x31x52 mm.

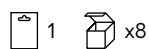

 **Tornillos** (incluidos)
Screws (included)

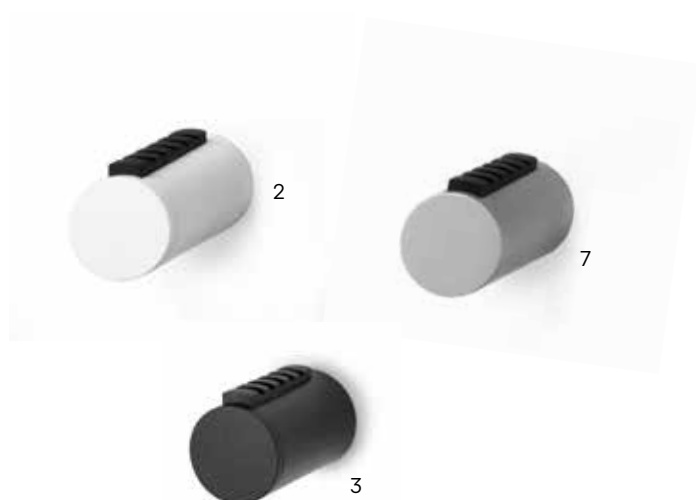

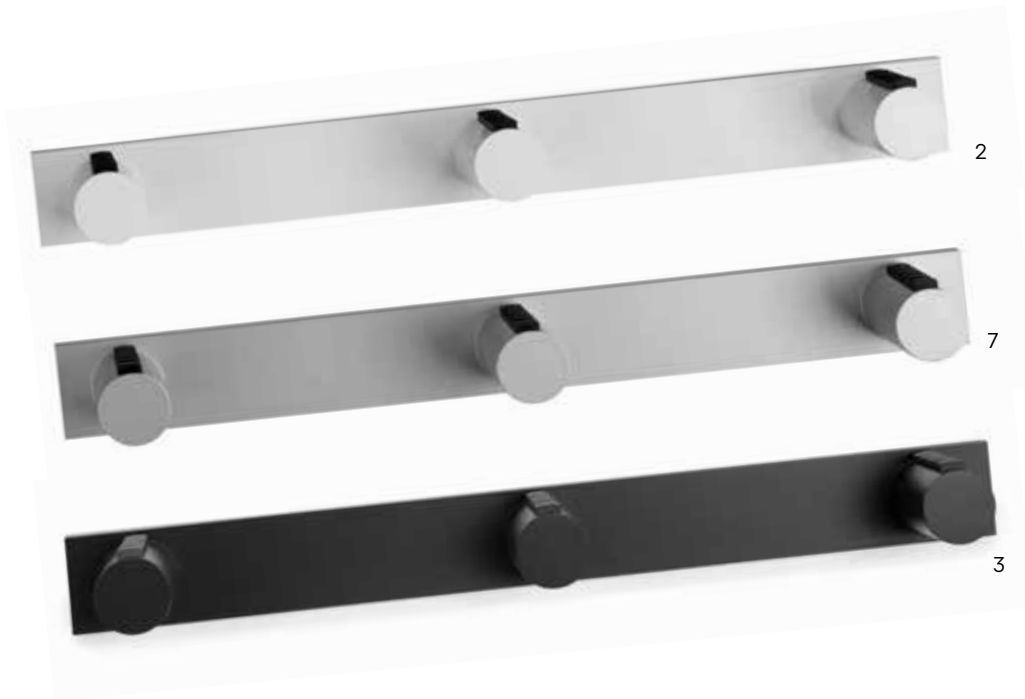

3089

Colgador múltiple.
Fijación con tornillos
(incluidos).
Three hook rack.
Screw-fastening
(screws included).

Medidas producto
Product measures
40x386x55 mm.

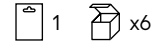

 **Tornillos** (incluidos)
Screws (included)

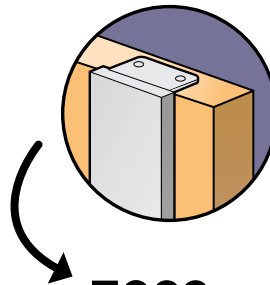
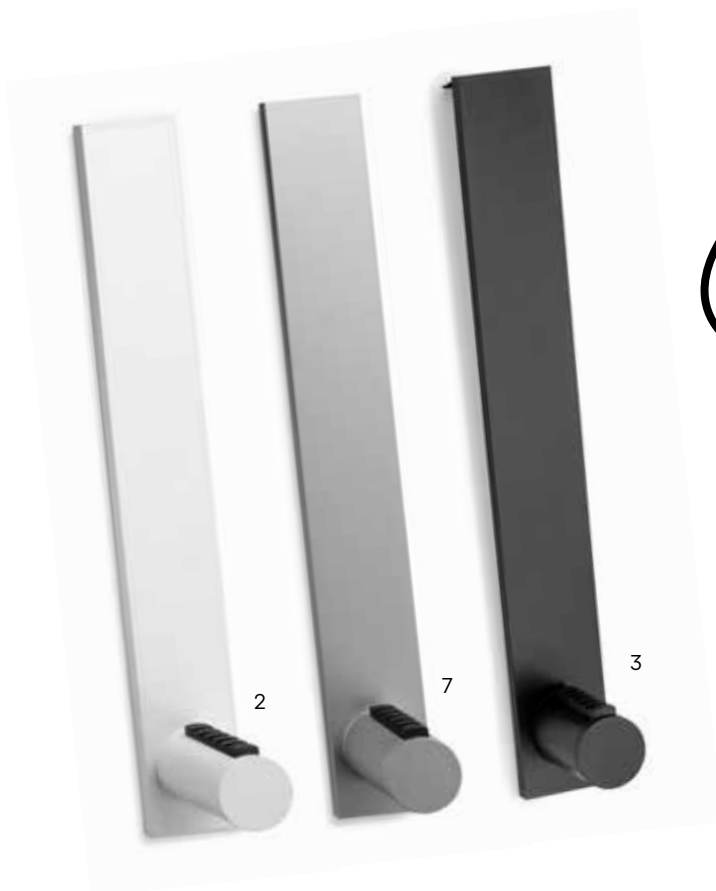

3088

Colgador sobre-
puerta individual.
Fijación con clavo
(incluido) y adhesivo.
Three hook rack.
Screw-fastening
(screws included).

Medidas producto
Product measures
296x40x77 mm.

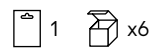

 **Clavos** (incluidos)
Nails (included)



3088S UNIVERSAL

Colgador sobre-
puerta individual. Fijación con
clavo (incluido) y adhesivo.
Over the door hanger.
Fastening with nail
(included) and adhesive.

Medidas producto
Product measures
296x40x66 mm.

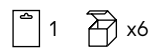

 **Clavos** (incluidos)
Nails (included)

Para todo tipo de puertas
For all kinds of doors





2

3720

Colgador sobrepuerta con 3 ganchos dobles.
Over the door 3 double hook rack.
For door thickness up to 4 cm.

Medidas producto
Product measures
197x270x110 mm.

 1  x4



0

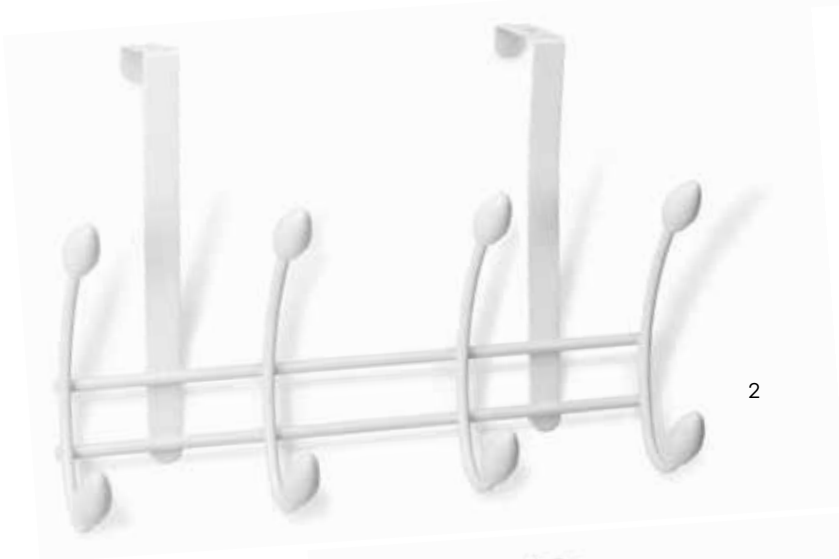



2

3721

Colgador sobrepuerta con 4 ganchos dobles.
Apto para un grosor de puerta de hasta 4cm.
Over the door 4 double hook rack.
For door thickness up to 4 cm.

Medidas producto
Product measures
208x306x109 mm.

 1  x4



3

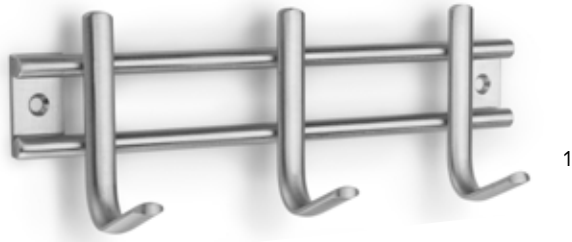

3716 INOX

Colgador de acero inoxidable con 3 ganchos.
Fijación con tornillos (incluidos).
Stainless steel three hook rack.
Screw-fastening (screws included).

Medidas producto
Product measures
76x220x54 mm.

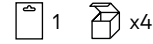

 **Tornillos** (incluidos)
Screws (included)

3717 INOX

Colgador de acero inoxidable con 4 ganchos.
Fijación con tornillos (incluidos).
Stainless steel four hook rack.
Screw-fastening (screws included).

Medidas producto
Product measures
76x300x54 mm.

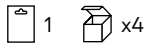

 **Tornillos** (incluidos)
Screws (included)

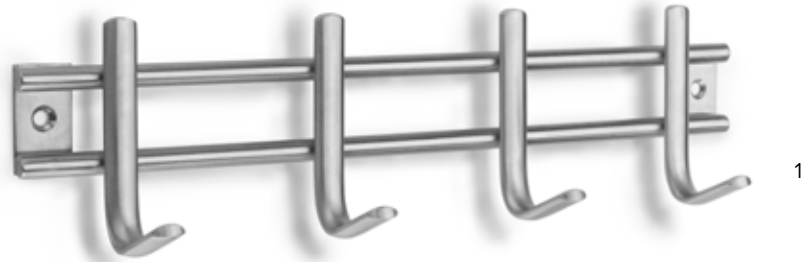

3718 INOX

Colgador de acero inoxidable con 3 ganchos dobles.
Fijación con tornillos (incluidos).
Stainless steel three double hook rack.
Screw-fastening (screws included).

Medidas producto
Product measures
150x220x68 mm.

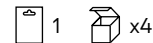

 **Tornillos** (incluidos)
Screws (included)



3719

Colgador de acero con 3 ganchos triples.
Fijación con tornillos (incluidos).
Steel peg with 3 triple hooks.
Screw-fastening (screws included).

Medidas producto
Product measures
130x310x84 mm.



 **Tornillos** (incluidos)
Screws (included)

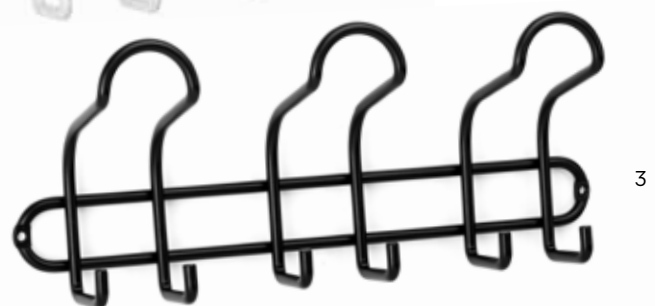



¡Atornillar y listos! Fácil fijación sobre madera. Perfectos para colgar múltiples accesorios.

Screw it down
and it's ready!

Easy fastening on
wood. Ideal for
hanging a wide
range of accessories.



9



7



9



7



9



7

3740

SURTIDO ASSORTMENT

Disponemos de caja surtida
para estos productos.
Incluye modelos 3750-3751-3752.
Assorted boxes are available
for these products.
Includes models 3750-3751-3752.



3750

Colgador de latón.
Fijación con tornillo (incluido).
Brass hook. Screw-fastening
(screws included).

Medidas producto
Product measures
66x41x42 mm.

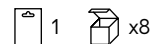

3751

Colgador de latón.
Fijación con tornillo (incluido).
Brass hook. Screw-fastening
(screws included).

Medidas producto
Product measures
66x40x42 mm.

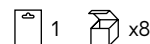

3752

Colgador de latón.
Fijación con tornillo (incluido).
Brass hook. Screw-fastening
(screws included).

Medidas producto
Product measures
66x36x35 mm.

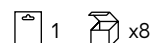



3760

Colgador clásico de latón.
Fijación con tornillos (incluidos).
 Classic hook in brass.
 Screw-fastening (screws included).

Medidas producto
 Product measures
 40x20x30 mm.



 **Tornillos (incluidos)**
Screws (included)



3055

Colgador de acero individual.
Fijación con tornillos (no incluidos).
 Single steel hook.
 Screw-fastening (screws not included).

Medidas producto
 Product measures
 59x20x49 mm.



3761

Colgador clásico doble de latón.
Fijación con tornillos (incluidos).
 Classic double hook in brass.
 Screw-fastening (screws included).

Medidas producto
 Product measures
 41x60x40 mm.



 **Tornillos (incluidos)**
Screws (included)



3056

Colgador de acero doble.
Fijación con tornillos (no incluidos).
 Double steel hook.
 Screw-fastening (screws not included).

Medidas producto
 Product measures
 116x20x66 mm.



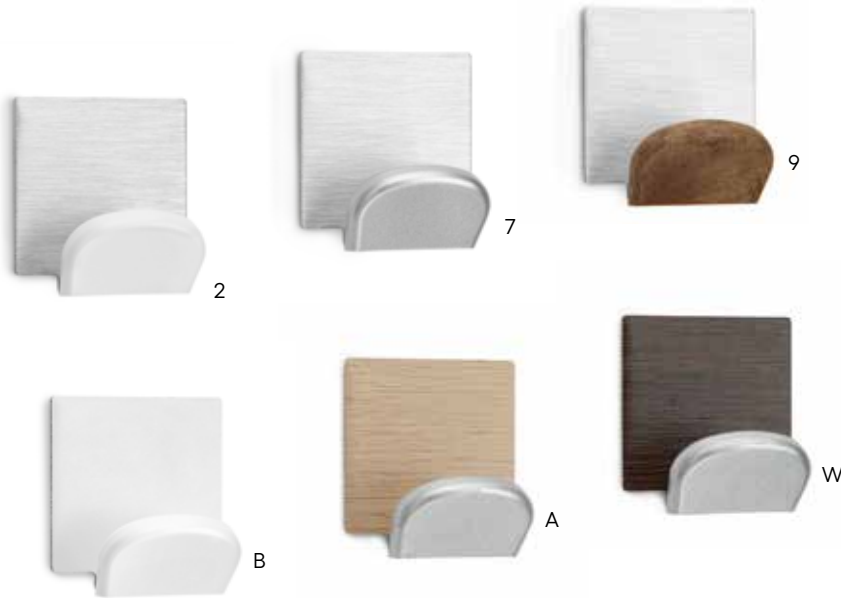

2078

AGUANTA
HOLDS

1.5 KG
3.3 LB

Colgadores adhesivos con base metálica.
Adhesive hook with metallic base.

Medidas producto
Product measures 45x40x30 mm.

2 x8

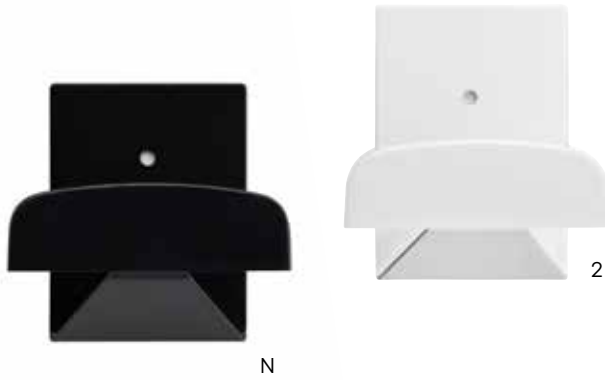

2010/2044

AGUANTA
HOLDS

1.5 KG
3.3 LB

Colgador adhesivo con base de acero pintada.
Fijación opcional con tornillo (no incluido).
Adhesive hook with steel painted base.
Optional screw-fastening (screws not included).

Medidas producto
Product measures 52x40x35 mm.

2010 3 x10

2044 1 x10

3076

Colgadores múltiples con base de acero pintada.
Fijación con tornillos (incluidos).
Hook racks with steel painted base.
Screw-fastening (screws included).

Medidas producto
Product measures 45x192x40 mm.

1 x10

Tornillos (incluidos)
Screws (included)



3077

Colgadores múltiples con base de acero pintada.
Fijación con tornillos (incluidos).
Hook racks with steel painted base.
Screw-fastening (screws included).

Medidas producto
Product measures 45x330x40 mm.

1 x10



Tornillos (incluidos)
Screws (included)



AGUANTA
HOLDS 1,5 KG
3,3 LB

2013 / 2045

Colgadores adhesivos con base de acero inoxidable. Fijación opcional con tornillo (no incluido). Adhesive hooks with stainless steel base. Optional screw-fastening (screws not included).

Medidas producto
Product measures
52x40x35 mm.

2013  3  x10

2045  1  x10

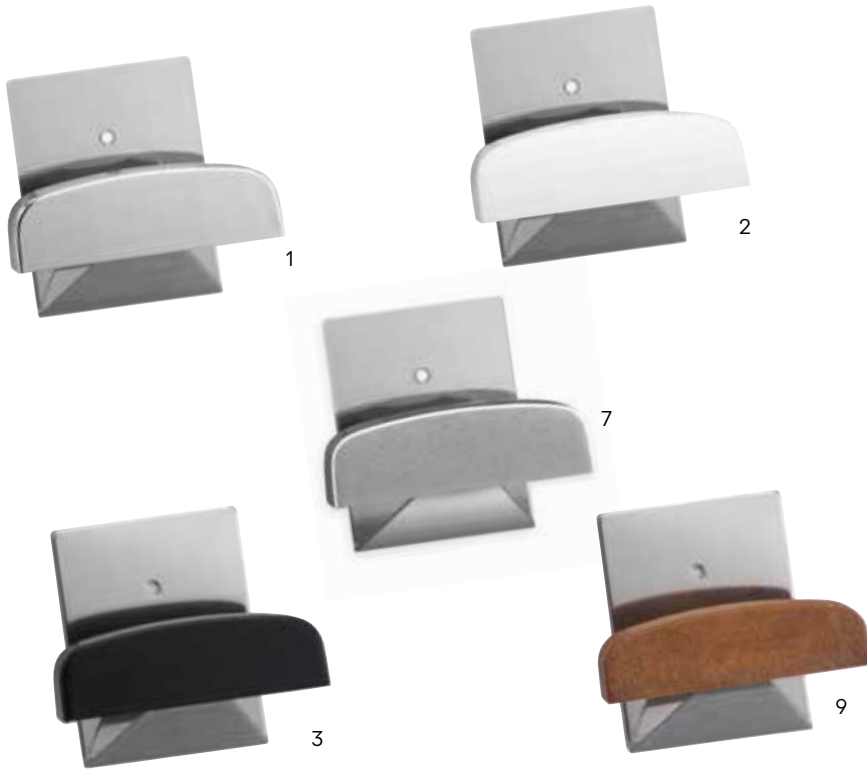

3062

Colgadores múltiples con base de acero inoxidable. Fijación con tornillos (incluidos). Hook racks with stainless steel base. Screw-fastening (screws included).

Medidas producto
Product measures
45x192x40 mm.

 1  x10

 **Tornillos** (incluidos)
Screws (included)



3061

Colgadores múltiples con base de acero inoxidable. Fijación con tornillos (incluidos). Hook racks with stainless steel base. Screw-fastening (screws included).

Medidas producto
Product measures
45x330x40 mm.

 1  x10

 **Tornillos** (incluidos)
Screws (included)

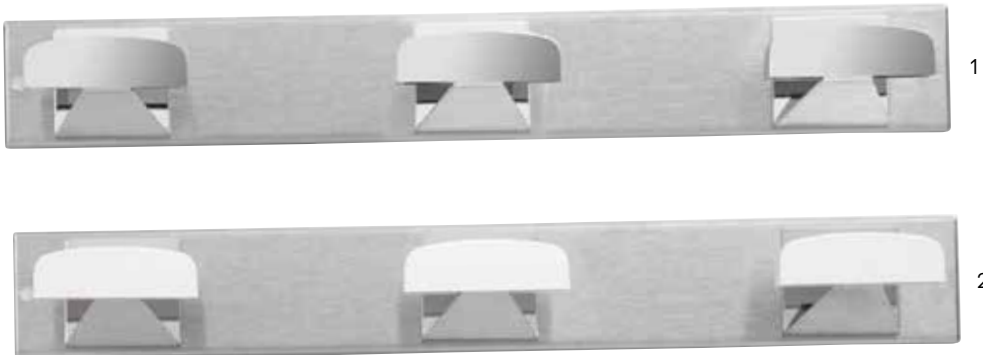



1



2



2015

AGUANTA
HOLDS

1,5 KG
3,3 LB

Colgador adhesivo. Fijación opcional con tornillo (no incluido).
Adhesive hanger.
Optional screw-fastening (screws not included).

Medidas producto
Product measures
61x45x45 mm.

 1  x6



2



2085

AGUANTA
HOLDS

1,5 KG
3,3 LB

Colgador adhesivo.
Adhesive hanger.

Medidas producto
Product measures
55x60x53 mm.

 1  x8

3072

Colgador múltiple dos pomos. Fijación con tornillos (incluidos).
Adhesive hanger.
Two hook rack. Screw-fastening (screws included).

Medidas producto
Product measures
47x265x44 mm.

 1  x10

 **Tornillos** (incluidos)
Screws (included)



2

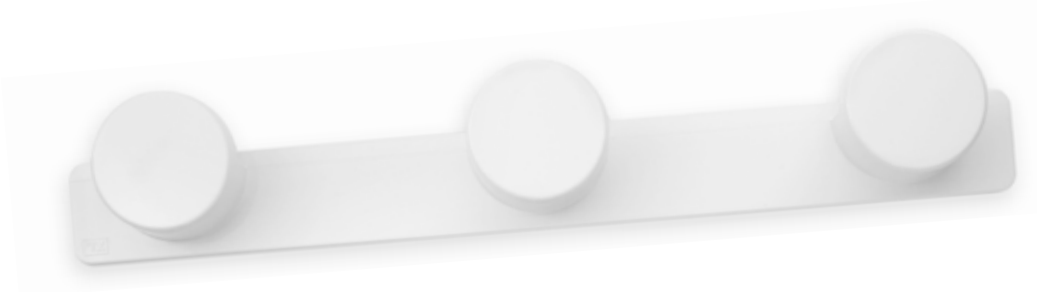



2

3073

Colgador múltiple tres pomos. Fijación con tornillos (incluidos).
Three hook rack. Screw-fastening (screws included).

Medidas producto
Product measures
47x430x44 mm.

 1  x10

 **Tornillos** (incluidos)
Screws (included)

MINI COLGADORES

MINI HOOKS

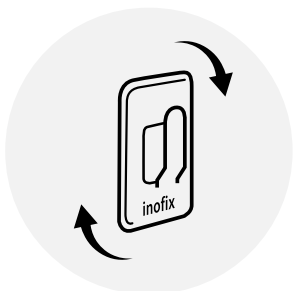

**ROTAR PARA
RETIRAR**
ROTATE TO
REMOVE

2107

Conjunto de 12 mini ganchos transparentes y 14 plaquitas adhesivas.

Para colgar objetos ligeros.

Se pueden retirar sin dejar rastro.

Set of 12 mini transparent hooks and 14 adhesive plates. They are suitable for hanging small objects. The special adhesive leaves no trace when removed.

Medidas producto
Product measures
20x10x5 mm.

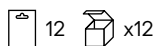

0

2107 CAJA/BOX

Caja expositora con 48 blisters modelo 2107.
Display box with 48 blisters, model 2107.

(*) Disponible es Español/Portugués
Available in Spanish/Portuguese

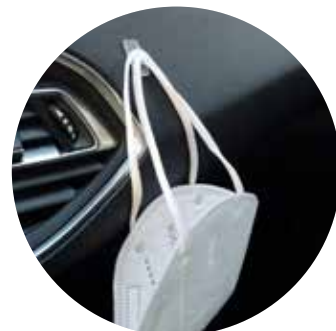
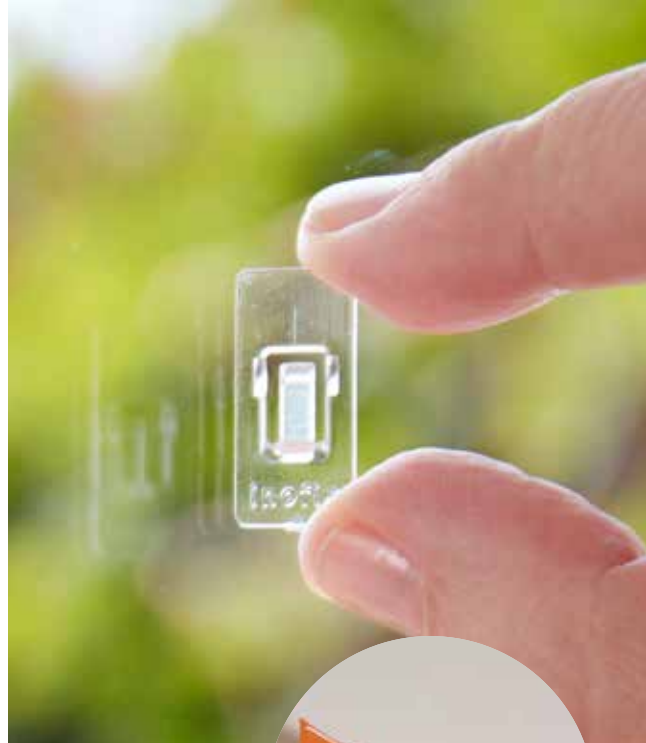
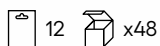

Barcelona

INSPIRACIÓN / INSPIRATION

¡Llévate un pedacito de Barcelona a tu hogar!

Take a small piece of Barcelona home!



2301/2302/ 2303/2304

Colgador adhesivo
pavimento Barcelona.
Adhesive hook Barcelona slabs.

Medidas producto
Product measures
46x32x20 mm.



2300

SURTIDO ASSORTMENT

Disponemos de caja surtida
para estos productos.
Incluye modelos 2301-
2302-2303-2304.

Assorted boxes are available
for these products.
Includes models 2301-
2302-2303-2304.



2301

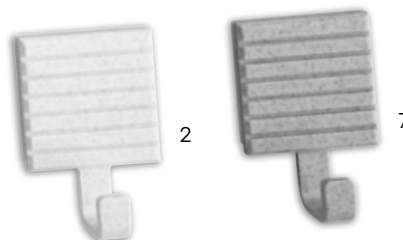

2302

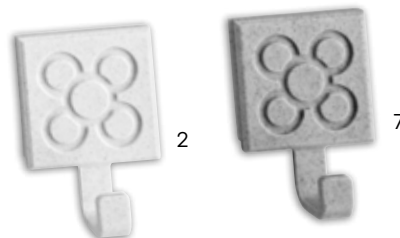

2303

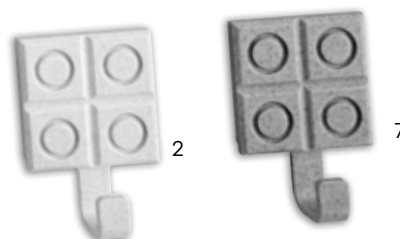

2304

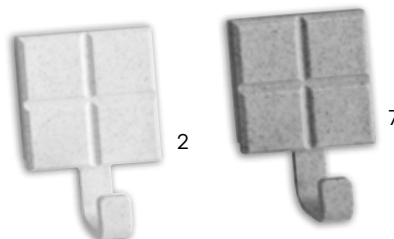



2170

AGUANTA
HOLDS

1 KG

2,2 LB

Colgador adhesivo.
Adhesive hanger.

Medidas producto
Product measures
53x42x17 mm.

📦 2 📦 x16

2170

SURTIDO
ASSORTMENT

Disponemos de caja surtida
para este producto.

Incluye colores: 3-4-5-6.

Assorted boxes are available
for this product.

Includes colours: 3-4-5-6.

📦 2 📦 x16

Diseños actuales inspirados en la simplicidad.

Modern designs inspired by simplicity.

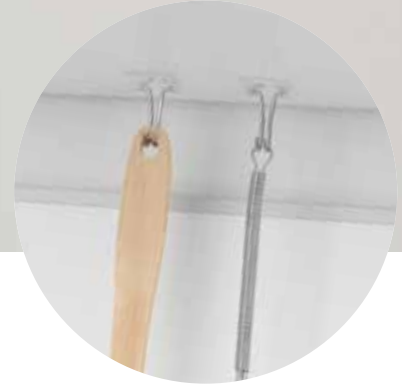

2106

AGUANTA
HOLDS 0,25 KG
0,5 LB

Colgador adhesivo con gancho móvil.
Adhesive mobile hook.

Medidas producto
Product measures
41x20x16 mm.

📦 2 📦 x10

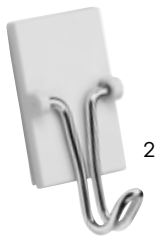

2320

AGUANTA
HOLDS 1 KG
2,2 LB

Colgador adhesivo de acero inoxidable y madera.
Adhesive hook in stainless steel and wood.

Medidas producto
Product measures
51x45x24 mm

📦 1 📦 x12



2077

AGUANTA
HOLDS 1 KG
2,2 LB

Colgador adhesivo de acero inoxidable.
Adhesive hook in stainless steel and wood.

Medidas producto
Product measures
46x32x24 mm.

📦 2 📦 x12



2305

AGUANTA
HOLDS

1 KG
2.2 LB

Colgador adhesivo
semitransparente.
Semitransparent
adhesive hook.

Medidas producto
Product measures
46x32x20 mm.

2 x20

2305

**SURTIDO
ASSORTMENT**

Disponemos de caja surtida
para este producto.
Incluye colores: 5-8-9.
Assorted boxes are available
for this product.
Includes colours: 5-8-9.

2 x20

2311

AGUANTA
HOLDS

1 KG
2.2 LB

Colgador adhesivo circular.
Adhesive circular hook.

Medidas producto
Product measures
Ø38x22 mm.

2 x14

2311

**SURTIDO
ASSORTMENT**

Disponemos de caja surtida
para este producto.
Incluye colores: 2-4-5-6-8-9.
Assorted boxes are available
for this product.
Includes colours: 2-4-5-6-8-9.

2 x14

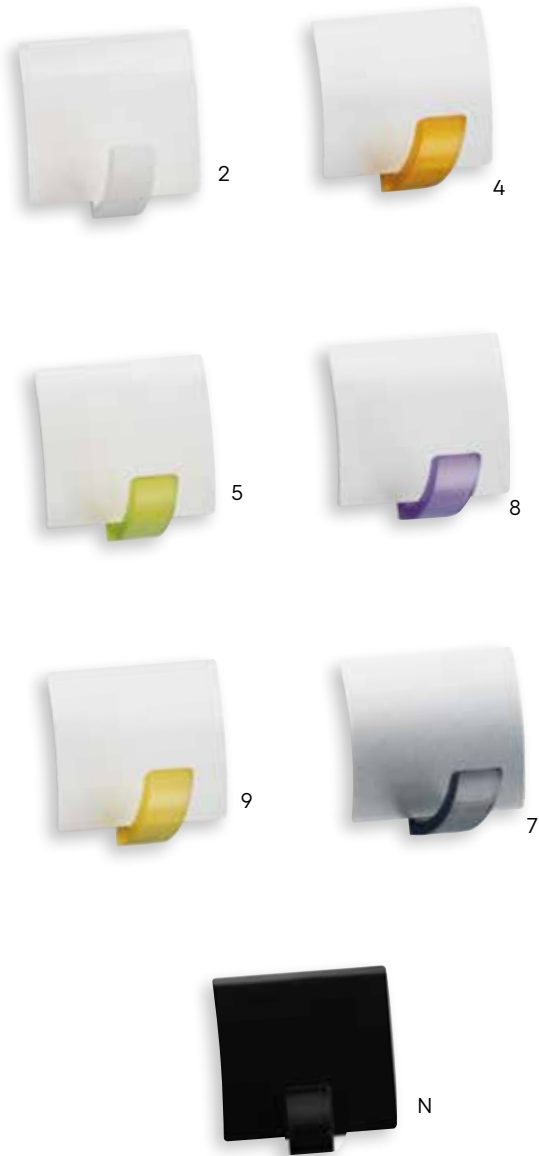





2310





Colgador adhesivo cuadrado.
Fijación opcional con
tornillo (no incluido).
Adhesive square hook.
Optional screw-fastening
(screws not included).

Medidas producto
Product measures
42x40x25 mm.

A-B-C-F  1  x12
2-4-5-8-9  2  x12



2310-0-
SURTIDO
ASSORTMENT

Caja surtida, incluye
colores 2-4-5-8-9.
Assorted box, includes
colours 2-4-5-8-9.

 2  x12

2310-S-
SURTIDO
ASSORTMENT

Caja surtida, incluye
colores A-B-C-F.
Assorted box, includes
colours A-B-C-F.

 1  x12



3





8

2061

Colgador adhesivo.
Adhesive hanger.

Medidas producto
Product measures
45x32x21 mm.

 2  x16



3



8



2063

AGUANTA
HOLDS

0,5 KG
1,1 LB

Colgador adhesivo.
Adhesive hanger.

Medidas producto
Product measures
45x32x21 mm.

 2  x16

2069

AGUANTA
HOLDS

0,25KG
0,5 LB

Mini colgador adhesivo.
Adhesive mini hook.

Medidas producto
Product measures
30x21x12 mm.

 3  x20



3



8

2071

Mini colgador adhesivo.
Adhesive mini hook.

Medidas producto
Product measures
30x21x12 mm.

 3  x20



3



8



2176

Colgador adhesivo de acero inoxidable.
Stainless steel adhesive hook.

Medidas producto
Product measures
27xØ40 mm.

2 x12

AGUANTA
HOLDS **1 KG**
2,2 LB



2179

Colgador adhesivo.
Adhesive hook.

Medidas producto
Product measures
30xØ42 mm.

4 x10

AGUANTA
HOLDS **1 KG**
2,2 LB



2080

Colgador adhesivo.
Adhesive hook.

Medidas producto
Product measures
Ø35x21 mm.

2 x16

AGUANTA
HOLDS **0,5 KG**
1,1 LB



2075

Colgador adhesivo.
Adhesive hook.

Medidas producto
Product measures
30x18x18 mm.

4 x16

AGUANTA
HOLDS **0,25 KG**
0,5 LB



Una manera fácil y rápida de instalar los visillos que visten nuestras ventanas.

A fast and easy way of putting up net curtains.

2042

AGUANTA
HOLDS

0,25 KG
0,5 LB

Colgador adhesivo para visillos.
Adhesive hook for net curtains.

Medidas producto
Product measures
25x17x12 mm.

 4  x20



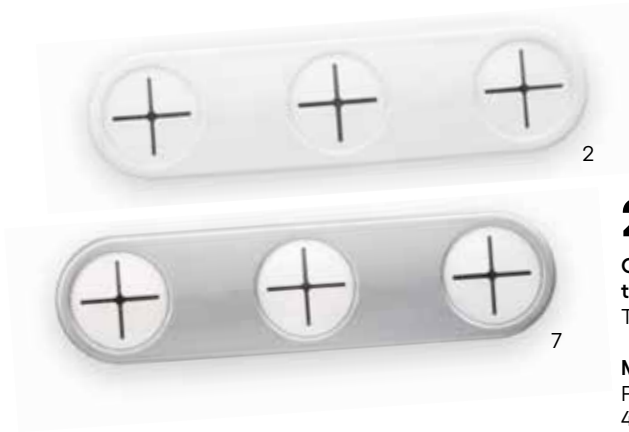

2083

AGUANTA
HOLDS

0,25 KG
0,5 LB

Colgador adhesivo triple para paños.
Triple adhesive cloth hook.

Medidas producto
Product measures
43x162x22 mm.

1 x10

2089

AGUANTA
HOLDS

0,25 KG
0,5 LB

Colgador adhesivo para paños.
Adhesive cloth hook.

Medidas producto
Product measures
Ø42x22 mm.

1 x12



2084

AGUANTA
HOLDS

1 KG
2,2 LB

Colgador adhesivo para paños.
Adhesive cloth hook.

Medidas producto
Product measures
Ø55x12 mm.

2 x10



2103

AGUANTA
HOLDS

0,5 KG
1,1 LB

Colgador adhesivo 3 ganchos
hecho de madera. Fijación opcional
con tornillos (no incluidos).
Three hook adhesive wooden rack.
Optional screw-fastening
(screws not included).

Medidas producto
Product measures
42x149x28 mm.

1 x10





¡Colgar, colgar y colgar!

Hang, hang and hang again!





2019

AGUANTA
HOLDS

0,5 KG
1,1 LB

Colgador adhesivo de acero inoxidable.
Fijación opcional con tornillo (no incluido).
Stainless steel adhesive hook.
Optional screw-fastening (screws not included).

Medidas producto
Product measures
26x18x12 mm.

 4  x16



2011

AGUANTA
HOLDS

0,5 KG
1,1 LB

Colgador adhesivo de acero inoxidable.
Fijación opcional con tornillo (no incluido).
Stainless steel adhesive hook.
Optional screw-fastening (screws not included).

Medidas producto
Product measures
26x18x12 mm.

 4  x16



2018

AGUANTA
HOLDS

1 KG
2,2 LB

Colgador adhesivo de acero inoxidable.
Fijación opcional con tornillo (no incluido).
Stainless steel adhesive hook.
Optional screw-fastening (screws not included).

Medidas producto
Product measures
40x24x21 mm.

 3  x12

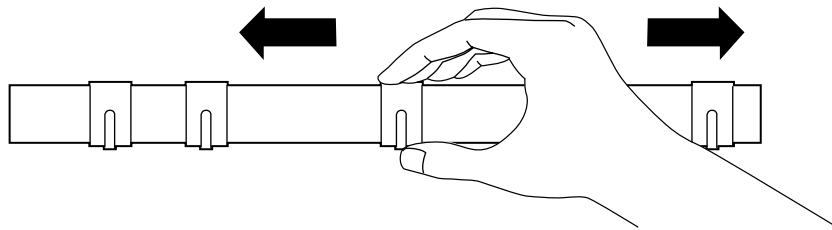

3075

Colgador múltiple con ganchos móviles.
Fijación con tornillos (incluidos).

Mobile hook rack.
Screw-fastening (screws included).

Medidas producto
Product measures
28x350x25 mm.

1 x 10

 **Tornillos** (incluidos)
Screws (included)



2040

**AGUANTA
HOLDS**
1KG
2,2 LB

Colgador adhesivo de acero inoxidable.
Fijación opcional con tornillo (no incluido).
Stainless steel adhesive hook.
Optional screw-fastening (screws not included).

Medidas producto
Product measures
41x25x17 mm.

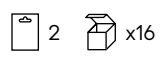

3084

Colgador de acero inoxidable con cuatro ganchos.
Fijación con tornillos (incluidos).
Stainless steel four hook rack.
Screw-fastening (screws included).

Medidas producto
Product measures
32x230x30 mm.

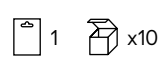

 **Tornillos** (incluidos)
Screws (included)



3086

Colgador de acero inoxidable con seis ganchos.
Fijación con tornillos (incluidos).
Stainless steel six hook rack.
Screw-fastening (screws included).

Medidas producto
Product measures
32x370x30 mm.

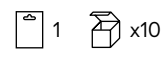

 **Tornillos** (incluidos)
Screws (included)



Cuelga cuadros sin perforar las paredes.

Hang pictures without wall drilling.



2



0

3000

Colgador de pared.
Nail hook.

Medidas producto
Product measures
Ø10x16 mm.

10 x20



2



0

3001

Colgador de pared.
Nail hook.

Medidas producto
Product measures
24x13x14 mm.

6 x20



2



0

3002

Colgador de pared.
Nail hook.

Medidas producto
Product measures
31x16x12 mm.

4 x20

3000-3001-3002

RISTRA/STRIP

Disponemos de presentación en ristras para este producto.

Strip-presentations available for this product.

10 x50



Con adhesivo reutilizable que no deja rastro.

With reusable adhesive that does not leave marks.



2351

Sujetanotas adhesivo.
Adhesive note holder.

Medidas producto
Product measures
Ø30x17 mm.

2 x20

2351

SURTIDO ASSORTMENT

Disponemos de caja surtida para este producto.
Incluye colores: 1 y 2.
Assorted boxes are available for this product.
Includes colours: 1 and 2.

2 x20



2351

RISTRA/STRIP

Disponemos de presentación en ristas para este producto.
Strip-presentations available for this product.

2 x40

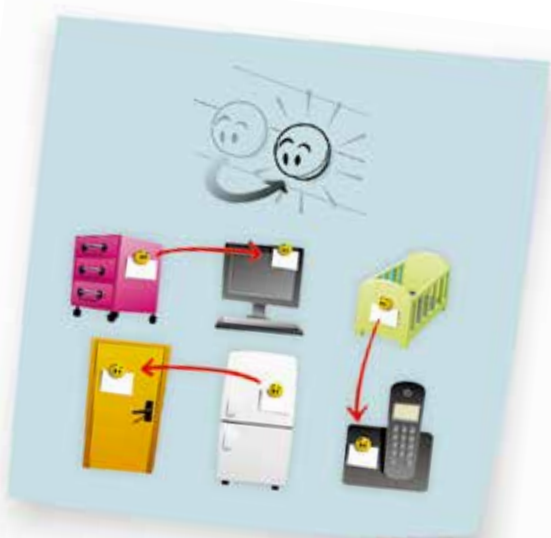

2351

CAJA/BOX

Caja expositora con 24 blisters surtidos modelo 2351.
Display box with 24 assorted blisters, model 2351.

2 x24

La calidad en los materiales garantiza una máxima sujeción.

The quality of these materials guarantees an optimal performance.



3033

Colgador doble para escobas. Fijación con tornillos (incluidos).
Two broom hook rack. Screw-fastening (screws included).

Medidas producto
Product measures 32x230x46 mm.

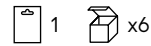

 **Tornillos** (incluidos)
Screws (included)



3034

Colgador triple para escobas. Fijación con tornillos (incluidos).
Three broom hook rack. Screw-fastening (screws included).

Medidas producto
Product measures 32x370x46 mm.

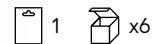



 **Tornillos** (incluidos)
Screws (included)



2055

Colgador adhesivo para escobas. Fijación opcional con tornillos (no incluidos).
Adhesive broom hook. Optional screw-fastening (screws not included).

Medidas producto
Product measures
34x52x42 mm.

 2  x8



2056

Colgador adhesivo para escobas con embellecedor. Fijación opcional con tornillos (no incluidos).
Adhesive broom hook with cover. Optional screw-fastening (screws not included).

Medidas producto
Product measures
35x85x52 mm.

 1  x6



2





3

1295

Cuelga escobas adherente y reutilizable Stick&Go! Fijación con tecnología microventosa.
Adhesive & reusable broom hook. Micro-suction pad fastening.

Medidas producto
Product measures
80x62x45 mm.

 1  x8



2055

CAJA/BOX

Caja expositora con 50 colgadores para escobas mod. 2055 color cromo mate, blanco y negro.
Display box with 50 broom hooks, model 2055 in matt-finish chrome, white and black.

 x50



Colgadores para organizar todo tipo de herramientas.

Hooks for all kinds of tools.

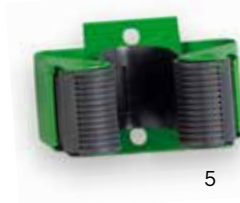

5

3036

Colgador para herramientas.
Fijación con tornillos (incluidos).
Adhesive tools hook.
Screw-fastening
(screws included).

Medidas producto
Product measures
34x52x42 mm.

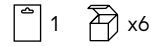

 **Tornillos** (incluidos)
Screws (included)



5

3038

Colgador triple para herramientas.
Fijación con tornillos (incluidos).
Three tool hook rack.
Screw-fastening (screws included).

Medidas producto
Product measures
32x370x46 mm.



 **Tornillos** (incluidos)
Screws (included)



3036

CAJA/BOX
Caja expositora con
50 colgadores para
herramientas
modelo 3036 color verde.
Display box with 50 tool
hooks, model 3036 in green.



3052

Colgador de acero
zincado para herramientas.
Fijación con tornillos
(incluidos).
Double tool hook in zinc plated
steel. Screw-fastening
(screws included).

Medidas producto
Product measures
64x77x48 mm.



 **Tornillos** (incluidos)
Screws (included)

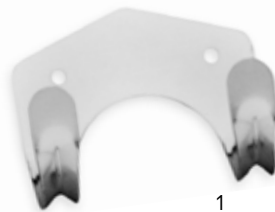

1

3053

Colgador de acero
zincado para herramientas.
Fijación con tornillos
(incluidos).
Double tool hook in zinc plated
steel. Screw-fastening
(screws included).

Medidas producto
Product measures
61x22x48 mm.

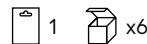

 **Tornillos** (incluidos)
Screws (included)



1



¡No deja rastro!
No trace!



**Resistentes
al agua**
Water resistant



1290

AGUANTA
HOLDS

3 KG
6,6 LB

Colgador adherente reutilizable y resistente al agua. Fijación con tecnología microventosa. Reusable, waterproof, adhesive hanger. Micro-suction pad fastening.

Medidas producto
Product measures
60x47x21 mm.

1 x10



1291

AGUANTA
HOLDS

5 KG
11 LB

Colgador adherente reutilizable y resistente al agua. Fijación con tecnología microventosa. Reusable, waterproof, adhesive hanger. Micro-suction pad fastening.

Medidas producto
Product measures
80x62x21 mm.

1 x10

1292

AGUANTA
HOLDS

3 KG
6,6 LB

Colgador adherente y reutilizable con gancho móvil. Fijación con tecnología microventosa. Reusable sticky hanger with swinging hook. Micro-suction pad fastening.

Medidas producto
Product measures
65x65x20 mm.

1 x10



1293

AGUANTA
HOLDS

10 KG
22 LB

Colgador adherente y reutilizable con 3 ganchos móviles. Fijación con tecnología microventosa. Reusable sticky hanger with 3 swinging hooks. Micro-suction pad fastening.

Medidas producto
Product measures
81x290x22 mm.

1 x6





1296

AGUANTA
HOLDS



Colgador adherente reutilizable y resistente al agua. Fijación con tecnología microventosa.

Reusable, waterproof, adhesive hanger. Micro-suction pad fastening.

Medidas producto
Product measures
110x61x30 mm.

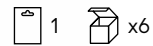

0



1294

AGUANTA
HOLDS



Soporte de fijación reutilizable con rosca. Fijación con tecnología microventosa.

Reusable fixing bracket with thread. Micro-suction pad fastening.

Medidas producto
Product measures
80x80x15 mm.

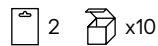

0



1216

AGUANTA
HOLDS

0,25 KG
0,5 LB

Colgador ventosa con gancho de acero inoxidable.
Stainless steel suction hook.

Medidas producto
Product measures
Ø22x13 mm.

4 x10

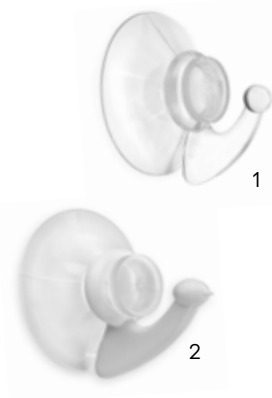

1206

AGUANTA
HOLDS

0,5 KG
1,1 LB

Colgador ventosa.
Suction hook.

Medidas producto
Product measures
Ø33x26 mm.

4 x10



***Envase surtido para este producto.**
Assorted pack available for this product.



1217

AGUANTA
HOLDS

0,5 KG
1,1 LB

Colgador ventosa con gancho de acero inoxidable.
Stainless steel suction hook.

Medidas producto
Product measures
Ø35x22 mm.

4 x10

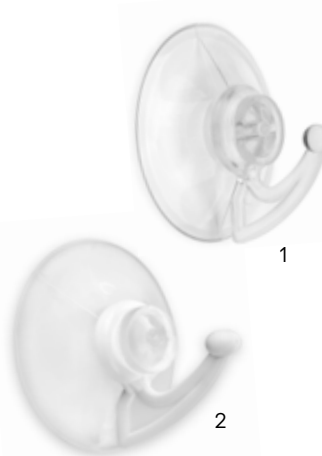

1207

AGUANTA
HOLDS

0,5 KG
1,1 LB

Colgador ventosa.
Suction hook.

Medidas producto
Product measures
Ø42x32 mm.

4 x8



***Envase surtido para este producto.**
Assorted pack available for this product.



1218

AGUANTA
HOLDS

1 KG
2,2 LB

Colgador ventosa con gancho de acero inoxidable.
Stainless steel suction hook.

Medidas producto
Product measures
Ø45x25 mm.

2 x10



1208

AGUANTA
HOLDS

1,5 KG
3,3 LB

Colgador ventosa con gancho articulado.
Articulated suction hook.

Medidas producto
Product measures
Ø42x35 mm.

📦 2 📦 x8

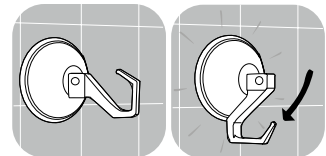

1232

Ventosa sin gancho.
Suction pad.

Medidas producto
Product measures
Ø22x10 mm.

📦 x50

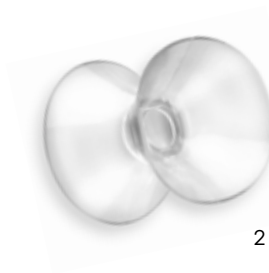

1205

Ventosa doble.
Double suction pad.

Medidas producto
Product measures
Ø31x18 mm.

📦 4 📦 x10



1233

Ventosa sin gancho.
Suction pad.

Medidas producto
Product measures
Ø35x13 mm.

📦 x50



1236

Ventosa sin gancho.
Suction pad.

Medidas producto
Product measures
Ø33x13 mm.

📦 x50



1234

Ventosa sin gancho.
Suction pad.

Medidas producto
Product measures
Ø45x16 mm.

📦 x50



1237

Ventosa sin gancho.
Suction pad.

Medidas producto
Product measures
Ø42x16 mm.

📦 x50

ACCESORIOS PARA PUERTAS Y VENTANAS

COMPLEMENTS
FOR DOORS AND
WINDOWS

Topes de puerta
Door stops

55

Retenedores de puerta
Door retainers

70

Protectores de golpes
Buffers

76

Burletes para puertas y ventanas
Draught excluders for doors
and windows

78

Tapajuntas
Coverstrips

84

Pestillos para puerta
Door latches

87



Topes textiles para puertas.

Fabric door stops.



9

3172

Tope textil 1 kg. Nudo.
Fabric door stop
1 Kg. Knot.

Medidas producto
Product measures
230x125x125 mm.

Und.  x2



5

3173

Tope textil 1 kg. Marino.
Fabric door stop
1 Kg. Navy.

Medidas producto
Product measures
190x160x110 mm.

Und.  x2



8

3174

Tope textil 1 kg. Saco.
Fabric door stop
1 Kg. Bag.

Medidas producto
Product measures
230x170x140 mm.

Und.  x2



3

3175

Tope textil 1 kg. Cactus.
Fabric door stop
1 Kg. Cactus

Medidas producto
Product measures
300x130x120 mm.

Und.  x2



8

3176

Tope textil 1 Kg. Elefante.
Fabric door stop 1 Kg. Elephant.

Medidas producto
Product measures
260x145x155 mm.

Und.  x2



2

3177

Tope textil 1 Kg. Gallina.
Fabric door stop
1 Kg. Hen.

Medidas producto
Product measures
270x250x120 mm.

Und.  x2



2

3178

Tope textil 1 Kg. Gato.
Fabric door stop
1 Kg. Cat

Medidas producto
Product measures
225x280x150 mm.

Und.  x2



4

3179

Tope textil 1 Kg. Perro.
Fabric door stop
1 Kg. Dog

Medidas producto
Product measures
205x350x120 mm.

Und.  x2



6

3180

Tope textil 1 Kg. Zorro.
Fabric door stop
1 Kg. Fox.

Medidas producto
Product measures
240x180x160 mm.

Und.  x2



Combinaciones en madera.

Combinations in wood.



2039

Tope de puerta adhesivo, hecho de madera.
 Adhesive door stop made of wood.

Medidas producto
 Product measures
 24x48x35 mm.

1 x10
 6 x5



3



1470

Tope de puerta adhesivo, hecho de madera.
 Adhesive door stop made of wood.

Medidas producto
 Product measures
 23 x Ø49 mm.

1 x12
 6 x25

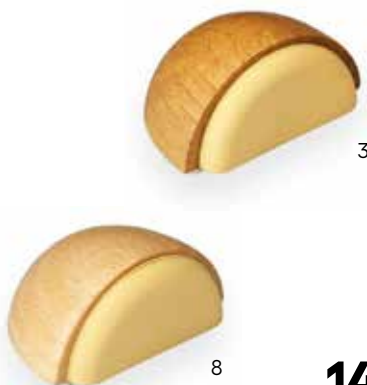

3

8



1440

Tope de puerta adhesivo, hecho de madera.
Fijación opcional con tornillo (incluido).
 Adhesive door stop made of wood.
 Optional screw-fastening (screws not included).

Medidas producto
 Product measures
 24x48x35 mm.

1 x10

Tornillos (incluidos)
Screws (included)



0



3046

Tope de puerta hecho de madera. Fijación con tornillo (incluido).
Door stop made of wood. Screw-fastening (screws included).

8

Medidas producto
Product measures
29 x Ø40 mm.



Tornillos (incluidos)
Screws (included)



3045

Tope de puerta hecho de madera. Fijación con tornillo (incluido).
Door stop made of wood. Screw-fastening (screws included).

Medidas producto
Product measures
29 x Ø40 mm.

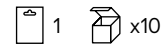

Tornillos (incluidos)
Screws (included)



2032

Tope de puerta adhesivo, hecho de madera.
Adhesive door stop made of wood.

3

Medidas producto
Product measures
29 x Ø40 mm.

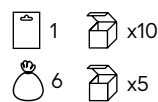

2038

Tope de puerta adhesivo, hecho de madera.
Adhesive door stop made of wood.

8

Medidas producto
Product measures
29 x Ø40 mm.

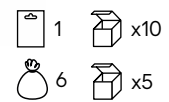



2098

Topes de puerta cilíndrico con tórica y adhesivo extrafuerte.

Topes sólido metálico con excelentes acabados imitación madera, transparente, blanco y cromo mate.

Round door stop with buffer and extra strong adhesive.

Solid metal door stop with premium wood-like finishes, transparent, white & matt chrome.

Medidas producto

Product measures
 18 x Ø46 mm.



Tope acero inoxidable

Stainless steel doorstop



Adhesivo extra-fuerte

Extra strong adhesive



2419

Tope cilíndrico de acero inoxidable con adhesivo extrafuerte.
Stainless steel cylindrical adhesive doorstop.

Medidas producto
Product measures
18 x Ø36 mm.



7



1



2



6



7

2099

Tope de puerta metálico y adhesivo.
Adhesive metallic door stop.

Medidas producto
Product measures
26 x Ø45 mm.



x10



x10



1



2



6



7

3049

Tope de puerta metálico.
Fijación con tornillo (incluido).
Metallic door stop.
Screw-fastening
(screws included).

Medidas producto
Product measures
26 x Ø45 mm.



x10



x10



Tornillos (incluidos)
Screws (included)



6



7

3160

Tope de puerta de acero inoxidable o latón.
Fijación con tornillo (incluido).
Stainless steel or brass door stop.
Screw-fastening
(screws included).

Medidas producto
Product measures
30 x Ø27 mm.



x10



x10



Tornillos (incluidos)
Screws (included)

3800

Anillas amortiguadoras
Ø17 mm para tope de
puerta mod. 3160.
Dampening O-Rings Ø17 mm
for door stop mod. 3160.

Medidas producto
Product measures
Ø26x5 mm.



x20

Und. x50



3

3163

Tope de puerta semiesférico
de acero inoxidable.
Fijación con tornillo (incluido).
Semispherical stainless
steel door stop.
Screw-fastening
(screws included).

Medidas producto
Product measures
18x57x46 mm.



x12



Tornillos (incluidos)
Screws (included)



7

3162

Tope de puerta semiesférico
de acero inoxidable.
Fijación con tornillo (incluido).
Semispherical stainless
steel door stop.
Screw-fastening
(screws included).

Medidas producto
Product measures
40 x Ø35 mm.



x10



Tornillos (incluidos)
Screws (included)



7



Transparentes

Transparents



2

2050

Tope de puerta adhesivo transparente.
Transparent adhesive door stop.

Medidas producto
Product measures
19x50x43 mm.



2054

Tope de puerta adhesivo, transparente y silencioso.
Transparent, silent and adhesive door stop.

Medidas producto
Product measures
18x41x52 mm.



0



0

2098

Tope de puerta adhesivo transparente.
Transparent adhesive door stop.

Medidas producto
Product measures
18 x Ø46 mm.







0

2033

Tope de puerta adhesivo flexible.
 Flexible adhesive door stop.

Medidas producto
 Product measures
 27 x Ø40 mm.

 2  x10

 6  x5



0



2035

Tope de puerta adhesivo con retenedor giratorio.
Para puertas de hasta 45mm de grosor.

Adhesive door stop with revolving retainer. For doors up to 45 mm thick.

Medidas producto
 Product measures
 27x40x108 mm.

 1  x10

 4  x5



0

2095

Tope y retenedor de puerta adhesivos.
 Adhesive door stop and door retainer.

Medidas producto
 Product measures
 27x40x40 mm.

 1  x10







0

2093

Tope de puerta adhesivo cilíndrico.
 Adhesive door stop cylinder.

Medidas producto
 Product measures
 20 x Ø40 mm.

 2  x10

 6  x10



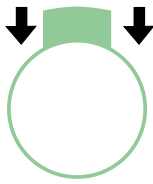

AMORTIGUADOR
SHOCK ABSORBER



2420

Topo de puerta adhesivo con efecto amortiguador. Fijación opcional con tornillos (no incluidos). Adhesive door stop with shock-absorption effect. Optional screw-fastening (screws not included).

Medidas producto
Product measures
24x40x48 mm.

 1  x10

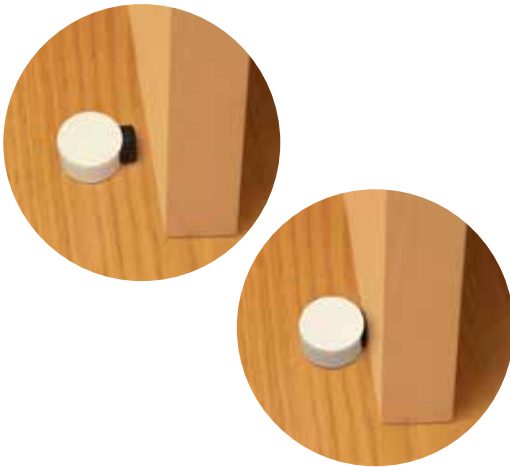

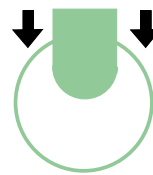

AMORTIGUADOR
SHOCK ABSORBER



2021

Topo de puerta adhesivo con efecto amortiguador. Base metálica. Fijación opcional con tornillos (no incluidos). Adhesive door stop with shock-absorption effect. Metal base. Optional screw-fastening (screws not included).

Medidas producto
Product measures
22 x Ø50 mm.

 1  x10

Suavidad en el impacto.

Impact-softening.



2



0



FLEXIBLE
FLEXIBLE



4



3



7







6

2033

Topo de puerta adhesivo flexible.
Flexible adhesive door stop.

Medidas producto
Product measures
27 x Ø40 mm.

 2  x10



 6  x5



2029 SILENCIOSO SILENT

Topes de puerta adhesivo silencioso con espuma amortiguadora.
 Silent adhesive door stop with shock-absorption foam.

Medidas producto
 Product measures 26x52x44 mm.



 1  x12



2031

Topes de puerta adhesivo con base metálica blanca.
 Adhesive door stop with painted metal base.

Medidas producto
 Product measures 18x45x45 mm.





 2  x10



2027 SILENCIOSO SILENT

Topes de puerta adhesivo silencioso con espuma amortiguadora.
 Silent adhesive door stop with shock-absorption foam.



Medidas producto
 Product measures 14 x Ø47 mm.



 1  x12
 6  x5

2023

Tope de puerta adhesivo con base metálica.
Adhesive door stop with metal base.

Medidas producto
Product measures
18x45x45 mm.

 2  x10

 6  x7



2



3



4



6



7



8



9

El primer tope de puerta adhesivo.



The original adhesive door stop.



3042

Tope de puerta. Fijación con tornillo (incluido).
Door stop. Screw-fastening (screws included).

Medidas producto
Product measures
18 x Ø38 mm.

 2  x12



2



4



6

3040

Tope de puerta.
Fijación con tornillo
(incluido).
Door stop.
Screw-fastening
(screws included)

Medidas producto
Product measures
34 x Ø28 mm.



 **Tornillos** (incluidos)
Screws (included)



2



6



4



4

6

7



2

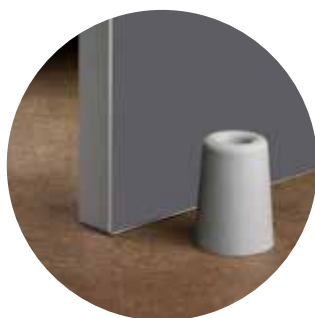

3047

CAUCHO
RUBBER

Tope de puerta de caucho.
Fijación con tornillo (incluido).
Rubber door stop.
Screw-fastening
(screws included).

Medidas producto
Product measures
51 x Ø38 mm.



 **Tornillos** (incluidos)
Screws (included)

3048

CAUCHO
RUBBER

Tope de puerta de caucho.
Fijación con tornillo
(no incluido).
Rubber door stop.
Screw-fastening (screws
not included).

Medidas producto
Product measures
35 x Ø29 mm.

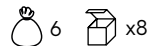



Suavidad en el impacto.

Impact-softening.

2460

SURTIDO ASSORTMENT

Disponemos de caja surtida para estos productos.

Incluye modelos 2461-2462-2463-2464.

Assorted boxes are available for these products.

Includes models 2461-2462-2463-2464.



2461

Topo de pared adhesivo. Adhesive wall door stop.

Medidas producto Product measures 63x63x18 mm.



2462

Topo de pared adhesivo. Adhesive wall door stop.

Medidas producto Product measures 71x74x18 mm.



2463

Topo de pared adhesivo. Adhesive wall door stop.

Medidas producto Product measures 61x55x18 mm.



2464

Topo de pared adhesivo. Adhesive wall door stop.

Medidas producto Product measures 77x67x18 mm.



Topes de pared.

Wall door stops.



0



8



3165

Topes de pared hecho de madera.

Fijación con tornillo (incluido).

Wall door stop made of wood. Screw-fastening (screws included).

Medidas producto

Product measures
Ø30 x 85 mm.

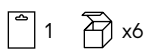

7

3164

Topes de pared en acero inoxidable.

Fijación con tornillo (incluido).

Wall door stop made of stainless steel. Screw-fastening (screws included).

Medidas producto

Product measures
Ø30 x 82 mm.

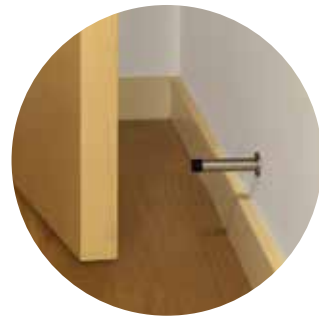
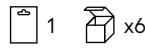

2



3



4



6



7



8



2450

Topes de pared adhesivo con efecto amortiguador.

Adhesive wall door stop with shock-absorption effect.

Medidas producto

Product measures
Ø33 x 18 mm.

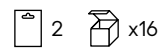

Doble función: tope + retenedor magnético.

Double function: door stop
+ magnetic retainer.

1

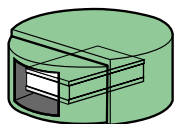

POSICIÓN TOPE

Actúa como tope con impacto amortiguado. El imán está escondido y no actúa con los impactos normales.

DOOR STOP POSITION

Acts as a stop, cushioning the impact. The magnet is at rest and does not come into action on impact.

2

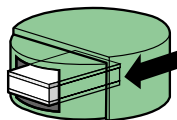

POSICIÓN RETENEDOR

Presionando la puerta contra el tope, la plaquita metálica atrae al imán y la puerta queda retenida.

RETAINER POSITION

When the door is pushed against the stop, the magnet moves and the door is held.

3

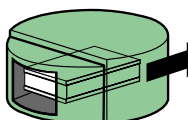

RETORNO AUTOMÁTICO

Separando la puerta del tope, el imán vuelve automáticamente a su posición de reposo.

AUTOMATIC RETURN

When the door is moved away from the stop, the magnet returns automatically to its position.



2037



Tope de puerta adhesivo
y retenedor magnético.

Adhesive door stop and
magnetic retainer.

Medidas producto
Product measures
23 x Ø50 mm.

1 x10

Retenedores de puerta magnéticos.

Magnetic door retainers.

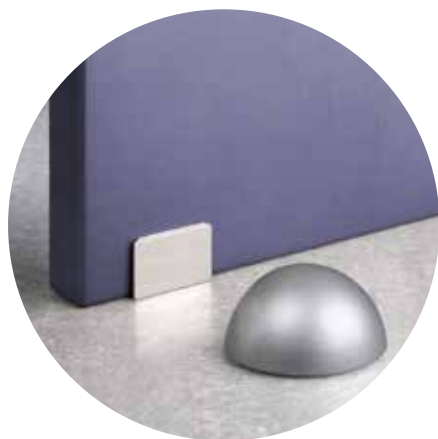

2036



Retenedor de puerta magnético en madera y con fijación adhesiva.
Wooden magnetic door retainer with adhesive fixation.

Medidas producto
Product measures
24x48x31 mm.



2034



Retenedor de puerta magnético con fijación adhesiva.
Magnetic door retainer with adhesive fixation.

Medidas producto
Product measures
26x52x38 mm.

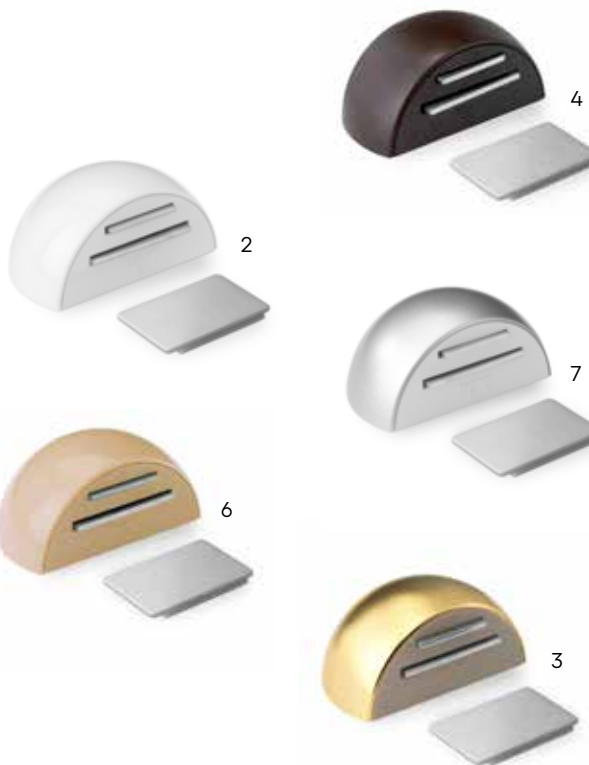

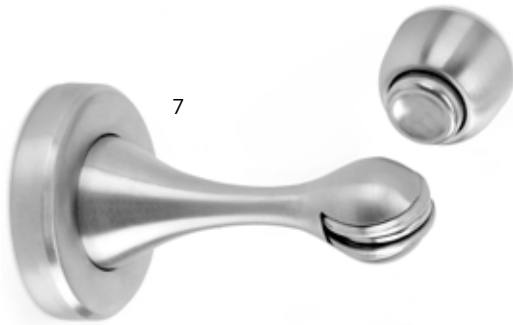

3167



Retenedor magnético metálico de pared.
Fijación con tornillos (incluidos).
 Wall magnetic metallic door retainer Screw-fastening (screws included).

Medidas producto
 Product measures
 48x48x99 mm.



 **Tornillos (incluidos)**
Screws (included)

3166



Retenedor magnético metálico.
Fijación con tornillos (incluidos).
 Magnetic metallic door retainer. Screw-fastening (screws included).

Medidas producto
 Product measures
 30x52x38 mm.

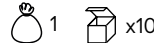
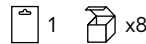

 **Tornillos (incluidos)**
Screws (included)

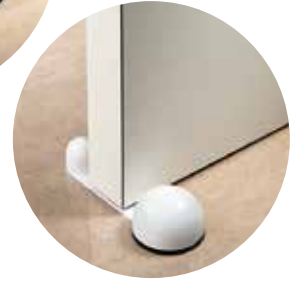
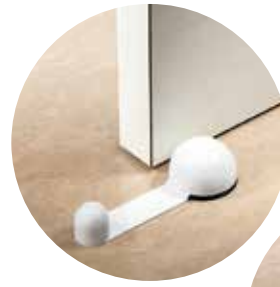

GIRATORIO
 REVOLVING

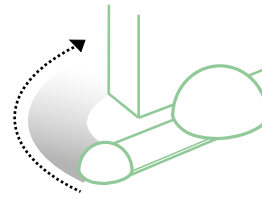

2035

Topo de puerta adhesivo con retenedor giratorio. Para puertas de hasta 45mm de grosor. Adhesive door stop with revolving retainer. For doors up to 45 mm thick.

Medidas producto
 Product measures
 27x40x108 mm.



2058

Topo de puerta adhesivo y retenedor giratorio con base metálica. Para puertas de hasta 45mm de grosor. Fijación opcional con tornillos (no incluidos). Revolving metallic door stop retainer. For doors up to 45 mm thick. Screw-fastening (screws not included).

Medidas producto
 Product measures
 24x34x101 mm.



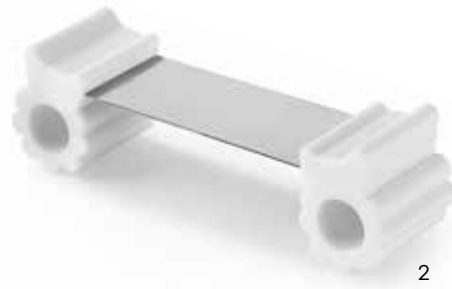

3171

Retenedor de puerta flexible.
Flexible door holder.

Medidas producto
Product measures
38x128x36 mm

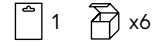

3014

Cuña para puertas.
Door wedge.

Medidas producto
Product measures
15x29x78 mm.

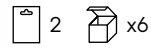

Retenedor de pie.

Foot-operated door retainer.

3170

Retenedor de pie.
Foot-operated door retainer.

Medidas producto
Product measures
154x44x25 mm.

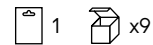



2095

Tope y retenedor de puerta adhesivos.
Adhesive door stop and door retainer.

Medidas producto
Product measures
27x40x40 mm.

 1  x10



Tope
Door stop



Retenedor
Retainer

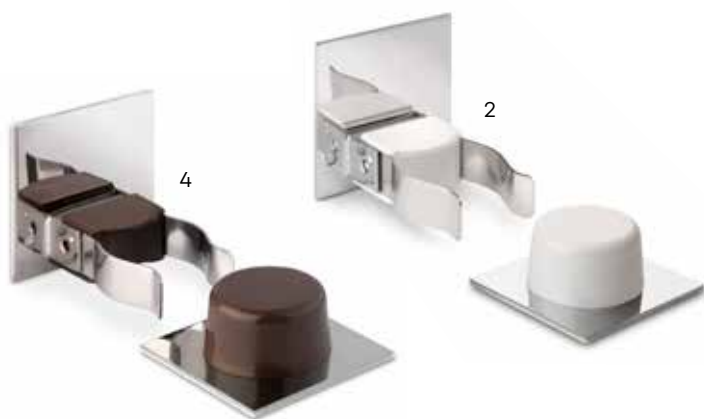
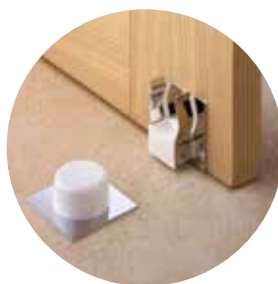

2025

Tope y retenedor de puerta adhesivos.
Adhesive door stop and door retainer.

Medidas producto
Product measures
27x40x40 mm.



 1  x10



2026

Retenedor de puerta adhesivo.
Adhesive door retainer.

Medidas producto
Product measures
48x48x49 mm.

 2  x10

Gotas adhesivas transparentes y antideslizantes.

Transparent and non-slip adhesive buffers.



2

4056

FORMATO MULTIFIGURA
MULTI SHAPE FORMAT

Incluye las siguientes medidas:

Following measures included:

Ø8mm - 16 unidades

Ø13mm - 4 unidades

Ø19mm - 4 unidades

18x13mm - 8 unidades

25x19mm - 4 unidades

📦 1 📦 x10



2

4050

Medidas producto
Product measures
Ø8 x 2,2 mm.

📦 24 📦 x20



2

4051

Medidas producto
Product measures
Ø12,7 x 3,5 mm.

📦 14 📦 x20



2

4052

Medidas producto
Product measures
Ø16 x 7,9 mm.

📦 6 📦 x20



2

4053

Medidas producto
Product measures
Ø19 x 4 mm.

📦 4 📦 x20



2

4054

Medidas producto
Product measures
12,7x12,7x3,1 mm.

📦 12 📦 x20



2

4055

Medidas producto
Product measures
20,5x20,5x7,6 mm.

📦 6 📦 x20



2090

Tope protector multi-uso adhesivo.
Adhesive buffer.

Medidas producto
Product measures
16 x 16 x 6 mm.

8 x20



2091

Tope protector multi-uso adhesivo.
Adhesive buffer.

Medidas producto
Product measures
12 x 12 x 5 mm.

18 x20

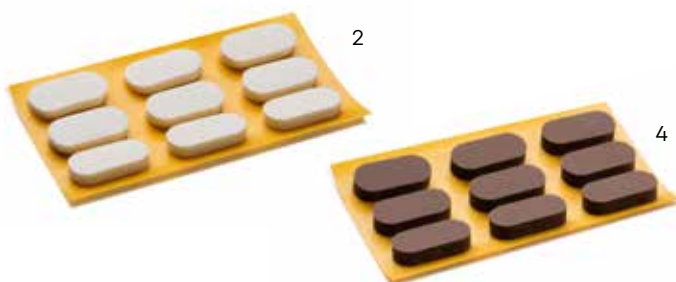

4060

Topes amortiguadores adhesivos.
Adhesive shock absorbers.

Medidas producto
Product measures
7 x 16 x 3 mm.

18 x20



3054

Tope para manilla de puerta Ø15-Ø18 mm.
Door handle stop
Ø15-Ø18 mm.

Medidas producto
Product measures
25x45x14 mm

6 x10



¿Cuál es la frontera entre el frío y el calor?

Where is the frontier between cold and warmth?

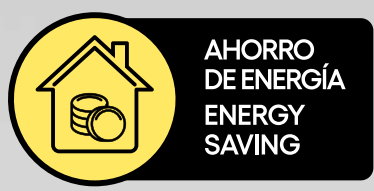

AHORRO DE ENERGÍA
ENERGY SAVING



Con nuestros burletes, aislantes del frío y del calor, se consigue una inmejorable protección térmica y un gran ahorro de energía.

Ours draught excluders afford unbeatable insulation against cold and heat, resulting in savings on fuel bills and ensuring a pleasant atmosphere indoors.

BURLETES DE SILICONA

SILICONE DRAUGHT EXCLUDERS

CARACTERÍSTICAS TÉCNICAS:

- Los burletes de silicona poseen propiedades especiales debido a que son elaborados con uno de los materiales más nobles.
- Conserva sus excelentes propiedades mecánicas a temperaturas extremas (desde -100°C hasta +250°C).
- Larga vida útil (más de 10 años). Mantiene sus propiedades con el paso del tiempo.
- Sometido a compresión siempre recupera su forma inicial. Amplio rango de aplicación: de 1 a 7 mm.
- Gran resistencia a la intemperie (UV ozono). Repele el agua.

TECHNICAL SPECIFICATIONS:

- Silicone draught excluders have special properties because they are made from one of the finest materials.
- They maintain their excellent mechanical properties at extreme temperatures (from -100°C to +250°C).
- Long service life (more than 10 years). They maintain their properties over time.
- After they have been under pressure, they always return to their initial shape. Wide range of application: from 1 to 7 mm.
- High weather-resistance (UV-ozone). Water-repellent.

2110

Burlete de silicona universal auto-adhesivo.
Universal self-adhesive silicone draught excluder.

Medidas producto
Product measures
7 x 9 mm x 6m.

1 x12

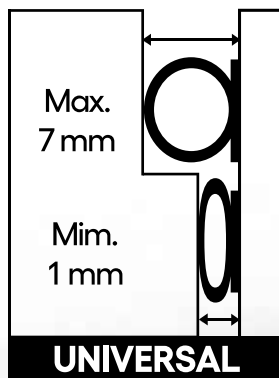

Perfil "Q"
Profile "Q"



BURLETES DE CAUCHO

RUBBER DRAUGHT EXCLUDERS

CARACTERÍSTICAS TÉCNICAS:

- Burletes de EPDM, un caucho-polímero que posee excepcionales características como aislante.
- El EPDM es resistente a la intemperie y al viento. No se resquebraja.
- Conserva su elasticidad y su forma tras prolongados períodos de uso.
- Se adapta a espacios de distinta anchura.
- No absorbe el agua gracias a que las celdas que componen este tipo de caucho son cerradas.
- Adecuado hasta temperaturas extremas: -50°C a +70°C.
- Larga vida: de 7 a 9 años.

TECHNICAL SPECIFICATIONS:

- Draught excluders made of EPDM, a polymer rubber with exceptional insulating properties.
- EPDM is weather-resistant and wind-resistant. It does not crack or split.
- It keeps its elasticity and shape even after prolonged use.
- It adapts to spaces of different widths.
- It does not absorb water as the cells in this type of rubber are closed cells.
- Suitable for extreme temperatures: -50°C to +70°C.
- Long lasting: 7 to 9 years.

80

2119

Burlete de caucho auto-adhesivo.
 Self-adhesive rubber draught excluder.

Medidas producto
 Product measures
 8 x 9 mm x 6m.

1 x20

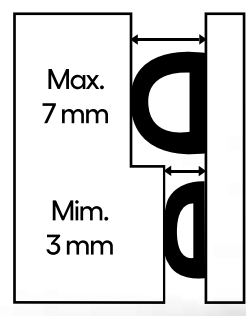

2115

Burlete de caucho auto-adhesivo.
Self-adhesive rubber draught excluder.

Medidas producto
Product measures
4 x 9 mm x 6m.

1 x24

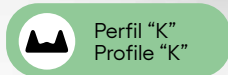
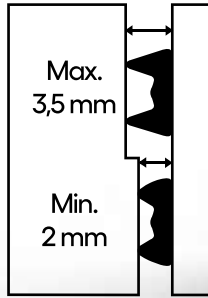

2116

Burlete de caucho auto-adhesivo.
Self-adhesive rubber draught excluder.

Medidas producto
Product measures
5,5 x 9 mm x 6m.

1 x24

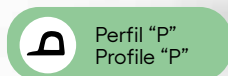
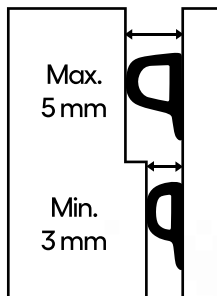



Protección contra el polvo y corrientes de aire.

Protection against
dust and draught.

3025

Burlete bajo puerta
flexible de espuma.
Flexible draught buster seal.

Medidas producto
Product measures
27x950x105 mm

 1  x8

¡Fácil de instalar!

Easy to install!



1
PASO . STEP



2
PASO . STEP



3
PASO . STEP



2150

Burlete bajo puerta adhesivo con cepillo.
 Adhesive door brush strip.

Medidas producto
 Product measures
 41x900x8 mm.

 1  x10



2156

Burlete bajo puerta adhesivo con cepillo.
 Adhesive door brush strip.

Medidas producto
 Product measures
 35x820x8 mm.

 1  x10

2157

Burlete bajo puerta adhesivo con cepillo.
 Adhesive door brush strip.

Medidas producto
 Product measures
 35x1000x8 mm.

 1  x10

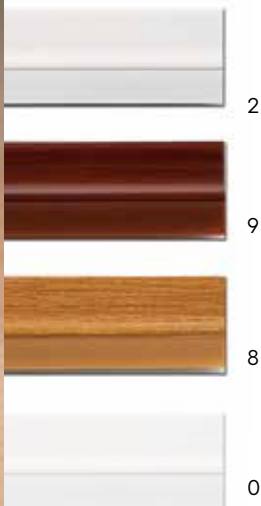
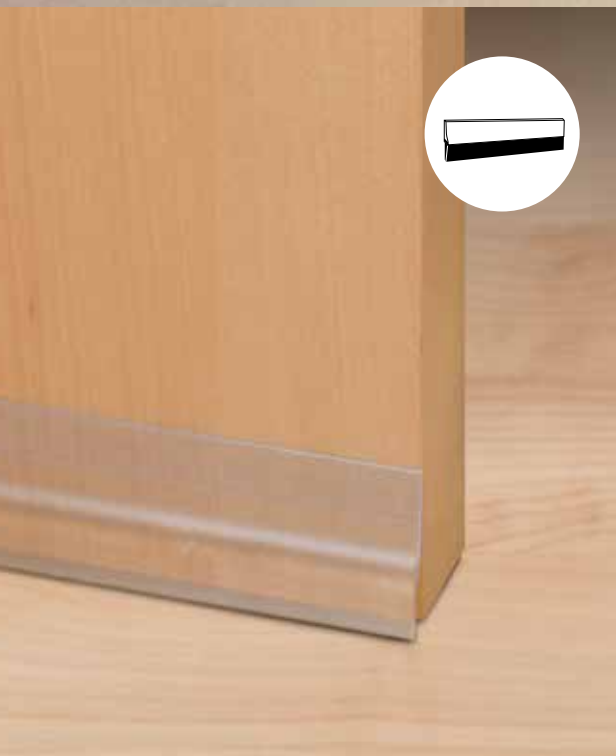

2154

Burlete bajo puerta adhesivo con perfil de PVC flexible.
 Adhesive door seal strip with flexible PVC flap.

Medidas producto
 Product measures
 35x820x4 mm.

 1  x10

2155

Burlete bajo puerta adhesivo con perfil de PVC flexible.
 Adhesive door seal strip with flexible PVC flap.

Medidas producto
 Product measures
 35x1000x4 mm.

 1  x10

Tapajuntas. Coverstrips.

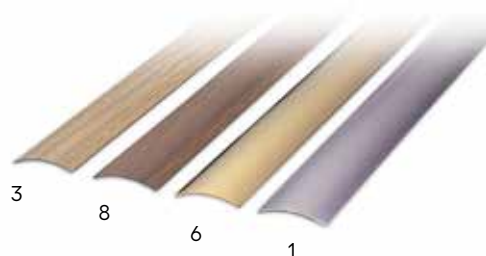

Perfil / Section

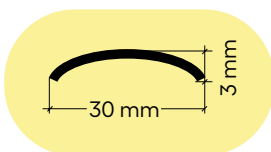

2138

Medidas producto
Product measures
£ 820 mm.



Tapajuntas metálicos
adhesivos.
Metallic adhesive
coverstrips.



Adhesivo
Adhesive

2139

Medidas producto
Product measures
£ 985 mm.



Perfil / Section

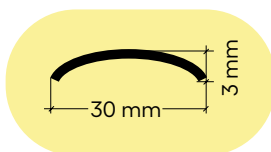

3138

Medidas producto
Product measures
£ 820 mm.



Tapajuntas metálicos
con tornillos incluidos.
Metallic coverstrips
with screws included.



Tornillos (incluidos)
Screws (included)

3139

Medidas producto
Product measures
£ 985 mm.



Perfil / Section

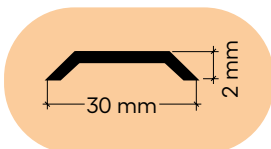

2124

Medidas producto
Product measures
£ 820 mm.



Tapajuntas metálicos
adhesivos.
Metallic adhesive
coverstrips.



Adhesivo
Adhesive

2125

Medidas producto
Product measures
£ 985 mm.

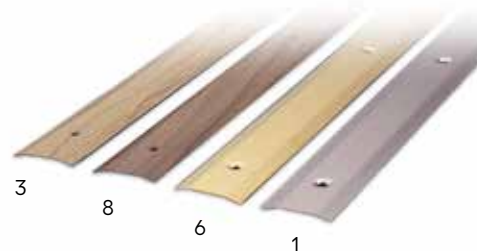

Perfil / Section

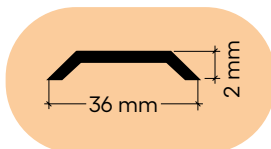

3124

Medidas producto
Product measures
£ 820 mm.



Tapajuntas metálicos
con tornillos incluidos.
Metallic coverstrips
with screws included.



Tornillos (incluidos)
Screws (included)

3125

Medidas producto
Product measures
£ 985 mm.



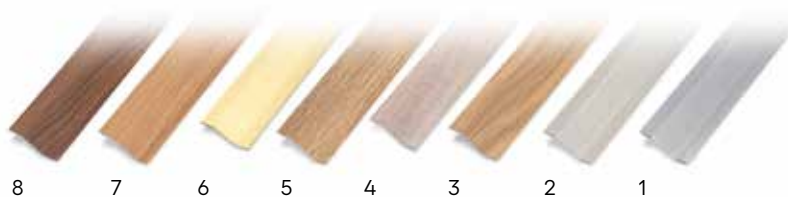

Perfil / Section

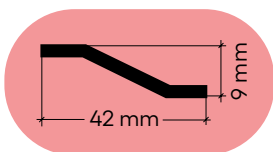

2127

Medidas producto
Product measures
£ 820 mm.



Tapajuntas metálicos
adhesivos.
Metallic adhesive
coverstrips.



Adhesivo
Adhesive

2128

Medidas producto
Product measures
£ 985 mm.



Perfil / Section

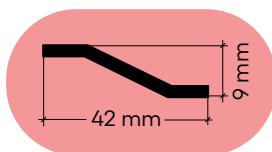

3127

Medidas producto
Product measures
£ 820 mm.



Tapajuntas metálicos
con tornillos incluidos.
Metallic coverstrips
with screws included.



Tornillos (incluidos)
Screws (included)

3128

Medidas producto
Product measures
£ 985 mm.



Perfil / Section

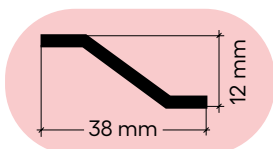

2135

Medidas producto
Product measures
£ 820 mm.



Tapajuntas metálicos
adhesivos.
Metallic adhesive
coverstrips.



Adhesivo
Adhesive

2136

Medidas producto
Product measures
£ 985 mm.



Perfil / Section

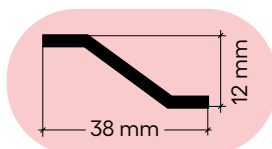

3135

Medidas producto
Product measures
£ 820 mm.



Tapajuntas metálicos
con tornillos incluidos.
Metallic coverstrips
with screws included.



Tornillos (incluidos)
Screws (included)

3136

Medidas producto
Product measures
£ 985 mm.



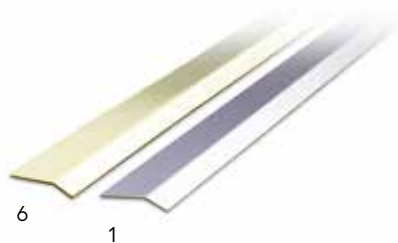

Perfil / Section

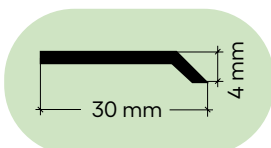

2121

Medidas producto
 Product measures
 † 820 mm.

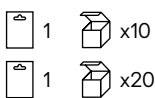

Tapajuntas metálicos adhesivos.
 Metallic adhesive coverstrips.



Adhesivo
 Adhesive

2122

Medidas producto
 Product measures
 † 985 mm.



Perfil / Section

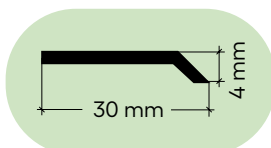

3121

Medidas producto
 Product measures
 † 820 mm.



Tapajuntas metálicos con tornillos incluidos.
 Metallic coverstrips with screws included.



Tornillos (incluidos)
 Screws (included)

3122

Medidas producto
 Product measures
 † 985 mm.



Perfil / Section

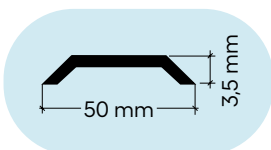

3132

Medidas producto
 Product measures
 † 820 mm.



Tapajuntas metálicos con tornillos incluidos.
 Metallic coverstrips with screws included.



Tornillos (incluidos)
 Screws (included)

3133

Medidas producto
 Product measures
 † 985 mm.



Pestillos.

Door latches.



1



2



6



8



9

3021

Pestillo para puerta.
Para uso en interiores.
Fijación con tornillo (incluido).
 Door latch. For indoor use.
 Screw-fastening
 (screws included).

Medidas producto
 Product measures
 25x77x12 mm.



 **Tornillos** (incluidos)
Screws (included)



2

3022

Pestillo para puerta.
Para uso en interiores.
Fijación con tornillo (incluido).
 Door latch. For indoor use.
 Screw-fastening
 (screws included).

Medidas producto
 Product measures
 25x77x12 mm.

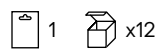

 **Tornillos** (incluidos)
Screws (included)

ACCESORIOS PARA MUEBLES

FURNITURE
COMPLEMENTS

Fieltros
Felts

89

Antideslizantes
Non-slip pads

93

Deslizadores y patines
Gliders

94

Conteras
Ferrules

97

Otros accesorios
Other complements

101



Fieltros de lana, la mejor manera de proteger las superficies.

Woollen felts, the best
protection for surfaces.

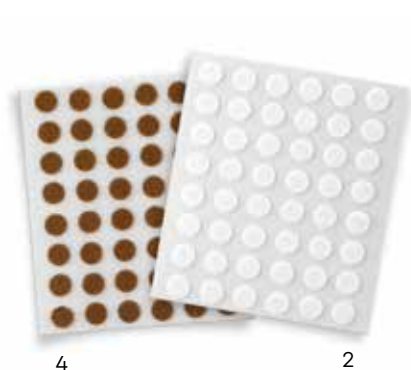

4011

Fieltro de lana adhesivo.
Adhesive woollen felt.

Medidas producto
Product measures
1 x Ø9 mm.

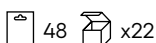

4003

Fieltro de lana adhesivo.
Adhesive woollen felt.

Medidas producto
Product measures
3 x Ø27 mm.

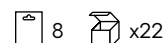

4001

Fieltro de lana adhesivo.
Adhesive woollen felt.

Medidas producto
Product measures
3 x Ø17 mm.

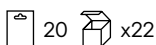

4009

Fieltro de lana adhesivo.
Adhesive woollen felt.

Medidas producto
Product measures
3 x Ø34 mm.

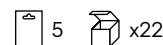

4002

Fieltro de lana adhesivo.
Adhesive woollen felt.

Medidas producto
Product measures
3 x Ø22 mm.

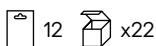

4013

Fieltro de lana adhesivo.
Adhesive woollen felt.

Medidas producto
Product measures
3 x Ø38 mm.

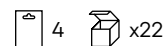



4007

Filtro de lana adhesivo.
Adhesive woolen felt.

Medidas producto
Product measures
3x95x12 mm.

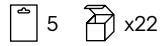

4014

Filtro de lana adhesivo.
Adhesive woolen felt.

Medidas producto
Product measures
3x31x31 mm.



4004

Filtro de lana adhesivo.
Adhesive woolen felt.

Medidas producto
Product measures
3x17x17 mm.

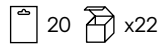

4008

Filtro de lana adhesivo.
Adhesive woolen felt.

Medidas producto
Product measures
3x100x85 mm.



4005

Filtro de lana adhesivo.
Adhesive woolen felt.

Medidas producto
Product measures
3x22x22 mm.

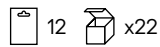

4018

Filtro de lana adhesivo.
Adhesive woolen felt.

Medidas producto
Product measures
3x100x85 mm.



4006

Filtro de lana adhesivo.
Adhesive woolen felt.

Medidas producto
Product measures
3x29x23 mm.



4010

Filtro de lana adhesivo.
Adhesive woolen felt.

Medidas producto
Product measures
3x100x85 mm.



Fieltros sintéticos, otra alternativa de calidad.

Synthetic felts,
another quality option.



4079

Filtro sintético
adhesivo.
Adhesive
synthetic felt.

Medidas producto
Product measures
3 x Ø34 mm.



4

2



4071

Filtro sintético
adhesivo.
Adhesive
synthetic felt.

Medidas producto
Product measures
3 x Ø17 mm.

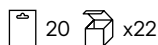

4

2



4083

Filtro sintético
adhesivo.
Adhesive
synthetic felt.

Medidas producto
Product measures
3 x Ø38 mm.

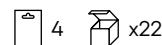

4

2



4072

Filtro sintético
adhesivo.
Adhesive
synthetic felt.

Medidas producto
Product measures
3 x Ø22 mm.

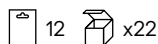

4

2



4077

Filtro sintético
adhesivo.
Adhesive
synthetic felt.

Medidas producto
Product measures
3x95x12 mm.

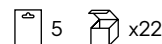

4

2



4073

Filtro sintético
adhesivo.
Adhesive
synthetic felt.

Medidas producto
Product measures
3 x Ø27 mm.



4

2



4074

Filtro sintético
adhesivo.
Adhesive
synthetic felt.

Medidas producto
Product measures
3x17x17 mm.

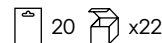

4

2



4

2

4075

Filtro sintético adhesivo.
Adhesive synthetic felt.

Medidas producto
Product measures
3x22x22 mm.

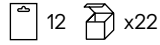

4

2

4088

Filtro sintético adhesivo (4 unidades).
Adhesive synthetic felt (4 units).

Medidas producto
Product measures
3x100x85 mm.

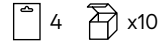

4

2

4076

Filtro sintético adhesivo.
Adhesive synthetic felt.

Medidas producto
Product measures
3x29x23 mm.

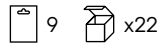

4

2

4080

Filtro sintético adhesivo.
Adhesive synthetic felt.

Medidas producto
Product measures
3x1000x85 mm.



4

2

4084

Filtro sintético adhesivo.
Adhesive synthetic felt.

Medidas producto
Product measures
3x31x31 mm.



4

4081

Filtro sintético adhesivo.
Adhesive synthetic felt.

Medidas producto
Product measures
3x200x500 mm.

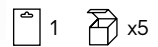

4

2

4078

Filtro sintético adhesivo.
Adhesive synthetic felt.

Medidas producto
Product measures
3x100x85 mm.



4

4082

Filtro sintético adhesivo.
Adhesive synthetic felt.

Medidas producto
Product measures
3x25mmx1,5m.



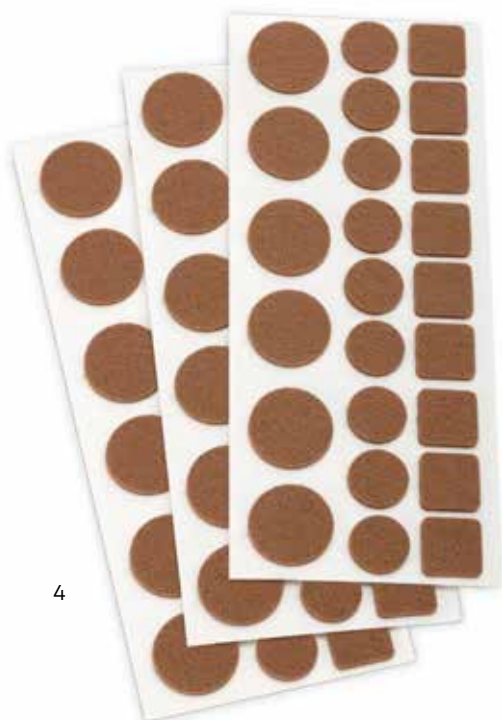

4

4089

Fieltro sintético adhesivo multifigura. Multi shape synthetic adhesive felt.



Medidas producto Product measures

72 PIEZAS PIECES	18 x ● Ø28 mm.
	27 x ● Ø20 mm.
	27 x ■ 20x20 mm.



Antideslizantes de máxima eficacia.

High effectiveness non-slip pads.



3

4030

Espuma adhesiva antideslizante. Adhesive non-slip foam.

Medidas producto Product measures 3x17x17 mm.

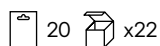

3

4031

Espuma adhesiva antideslizante. Adhesive non-slip foam.

Medidas producto Product measures 3x100x85 mm.

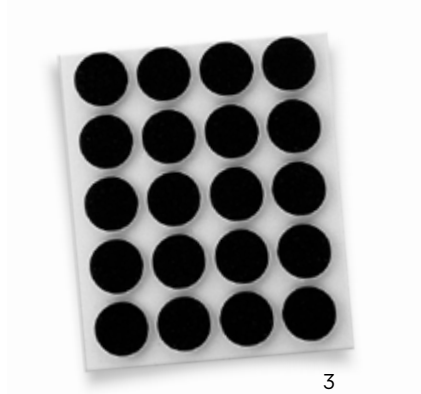

3

4033

Espuma adhesiva antideslizante. Adhesive non-slip foam.

Medidas producto Product measures 3 x Ø17 mm.

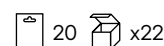



Ahorra esfuerzos innecesarios gracias a nuestros deslizadores para muebles.

Move your furniture around
 easily with our furniture gliders.



3507

Deslizador de PTFE
 (polytetrafluorethylene)
 adhesivo.
 Adhesive glider in PTFE
 (polytetrafluoroethylene).

Medidas producto
 Product measures
 5,5 x Ø30 mm.

4 x12

Und. x50



3510

Deslizador de PTFE
 (polytetrafluorethylene)
 adhesivo.
 Adhesive glider in PTFE
 (polytetrafluoroethylene).

Medidas producto
 Product measures
 5,5 x Ø25 mm.

4 x20



3508

Deslizador de PTFE
 (polytetrafluorethylene)
 adhesivo.
 Adhesive glider in PTFE
 (polytetrafluoroethylene).

Medidas producto
 Product measures
 5,5 x Ø40 mm.



4 x12

Und. x50

3511

Deslizador de PTFE (polytetrafluorethylene) adhesivo.
 Adhesive glider in PTFE (polytetrafluoroethylene).

Medidas producto
 Product measures
 5,5 x Ø50 mm.

 4  x12





7

3512

Deslizador de PTFE (polytetrafluorethylene) adhesivo.
 Adhesive glider in PTFE (polytetrafluoroethylene).

Medidas producto
 Product measures
 5,5 x Ø63 mm.

 4  x12





7

3513

Deslizador de PTFE (polytetrafluorethylene) adhesivo.
 Adhesive glider in PTFE (polytetrafluoroethylene).

Medidas producto
 Product measures
 4,5x35x25 mm.

 4  x18





7

3514

Deslizador de PTFE (polytetrafluorethylene) adhesivo.
 Adhesive glider in PTFE (polytetrafluoroethylene).

Medidas producto
 Product measures
 5x75x16 mm.

 4  x10

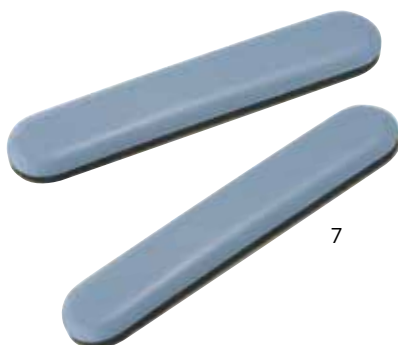



7

3515

Deslizador de PTFE (polytetrafluorethylene) con clavo.
 Nail-fastening glider in PTFE (polytetrafluoroethylene).

Medidas producto
 Product measures
 24 x Ø22 mm.

 4  x16





7

3516

Deslizador de PTFE (polytetrafluorethylene) con tornillo.
 Screw-fastening glider in PTFE (polytetrafluoroethylene).

Medidas producto
 Product measures
 6,5 x Ø22 mm.

 4  x20

 **Tornillos** (incluidos)
Screws (included)





7

3518

Deslizador de PTFE (polytetrafluorethylene) con tornillo.
 Screw-fastening glider in PTFE (polytetrafluoroethylene).

Medidas producto
 Product measures
 7,5 x Ø30 mm.

 4  x12

 **Tornillos** (incluidos)
Screws (included)





7

3517

Deslizador de PTFE (polytetrafluorethylene) con tornillo.
 Screw-fastening glider in PTFE (polytetrafluoroethylene).

Medidas producto
 Product measures
 7,5 x Ø38 mm.

 4  x10





 **Tornillos** (incluidos)
Screws (included)



7





Patines deslizantes
 metálicos.
 Metallic gliders.

Modelos Models	Medidas Measures	
3112	Ø15 mm.	 8  x20
3113	Ø18 mm.	
3114	Ø23 mm.	
3115	Ø26 mm.	
3116	Ø30 mm.	 4  x20







Patines deslizantes
 de plástico.
 Plastic gliders.

Modelos Models	Medidas Measures	
3140	Ø15 mm.	 8  x20
3141	Ø18 mm.	
3142	Ø20 mm.	



Patines deslizantes
 con fieltro.
 Felt gliders.

Modelos Models	Medidas Measures	
3145	Ø17 mm.	 8  x10
3146	Ø20 mm.	
3147	Ø24 mm.	
3148	Ø30 mm.	 4  x10
3149	Ø35 mm.	

Cada silla con su contera. Disponemos de una gran variedad en diámetros...

Each chair leg has its own tip.
Wide range of measures available...



Contera redonda
exterior de plástico.
Outer round-shaped
plastic tip.



Modelos Models	Medidas Measures	
1516	Ø16 mm.	8 x10
1518	Ø18 mm.	Und. x50
1520	Ø20 mm.	4 x10
1522	Ø22 mm.	Und. x50
1525	Ø25 mm.	Und. x50

Contera redonda exterior de
plástico con arandela.
Outer round-shaped
plastic tip with washer.



















Modelos Models	Medidas Measures	
1710	Ø10 mm.	8 x10 Und. x50
1712	Ø12 mm.	
1714	Ø14 mm.	
1716	Ø16 mm.	
1718	Ø18 mm.	4 x10 Und. x50
1720	Ø20 mm.	
1722	Ø22 mm.	
1725	Ø25 mm.	
1728	Ø28 mm.	
1730	Ø30 mm.	



3







Contera redonda exterior de goma.
Outer round-shaped rubber tip.

Modelos Models	Medidas Measures	
1910	Ø10 mm.	 4  x10 Und.  x25
1912	Ø12 mm.	
1914	Ø14 mm.	
1916	Ø16 mm.	
1917	Ø17 mm.	
1918	Ø18 mm.	
1919	Ø19 mm.	Und.  x25
1920	Ø20 mm.	 4  x10 Und.  x25
1921	Ø21 mm.	Und.  x25
1922	Ø22 mm.	 4  x10 Und.  x25
1925	Ø25 mm.	Und.  x25
1930	Ø30 mm.	 4  x9 Und.  x25
1935	Ø35 mm.	Und.  x25



3

Contera redonda exterior de plástico sin arandela.
Outer round-shaped plastic tip without washer.

Modelos Models	Medidas Measures	
1610	Ø10 mm.	Und.  x50
1612	Ø12 mm.	
1614	Ø14 mm.	
1616	Ø16 mm.	
1618	Ø18 mm.	
1620	Ø20 mm.	
1622	Ø22 mm.	
1625	Ø25 mm.	
1628	Ø28 mm.	
1630	Ø30 mm.	
1632	Ø32 mm.	
1635	Ø35 mm.	
1640	Ø40 mm.	 4  x9 Und.  x50
1645	Ø45 mm.	Und.  x50
1650	Ø50 mm.	

Conteras para elementos ortopédicos.

Tips for orthotics.



CONTERAS EXTERIORES
OUTER TIPS

Contera exterior de goma con ventosa.
Especial para muletas.
Outer rubber tip with suction pad.
Special tips for crutches.

Modelos Models	Medidas Measures	
1861*	Ø17 mm.	2 x8 Und. x25
1862	Ø19 mm.	
1863	Ø21 mm.	

*Disponibles sólo en color negro.
*Available only in black color.



con arandela / washer
de refuerzo / reinforcement
+40% / +40%
de grosor / thickness



Contera exterior de goma
con base ancha y arandela.
Outer rubber tip with wide
base and washer.

Modelos Models	Medidas Measures	
1847	Ø19 mm.	1 x8 Und. x10
1848	Ø22 mm.	

Contera exterior de goma
con arandela para andadores.
Outer rubber tip with washer
for walking frames.

Modelos Models	Medidas Measures	
1849	Ø25 mm.	2 x8 Und. x25



3

Contera de plástico especial para escaleras.
Special plastic tip for ladders.

Modelos Models	Medidas Measures	
1864	20x50 mm.	Und. x50



3

Contera interior ovalada de plástico.
Inner oval-shaped plastic tip.

Modelos Models	Medidas Measures	
1810	15x25 mm.	Und. x50
1812	15x30 mm.	
1814	20x40 mm.	

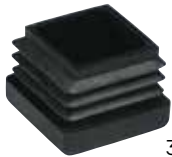

3

Contera interior cuadrada de plástico.
Inner square-shaped plastic tip.

Modelos Models	Medidas Measures	
1816	16x16 mm.	Und. x50
1818	18x18 mm.	
1820	20x20 mm.	4 x10
		Und. x50
1822	22x22 mm.	Und. x50
1825	25x25 mm.	4 x10
1830	30x30 mm.	
1835	35x35 mm.	Und. x50
1840	40x40 mm.	4 x9
		Und. x50
1845	45x45 mm.	Und. x50
1850	50x50 mm.	
1869	60x60 mm.	



3

Contera interior rectangular de plástico.
Inner rectangular-shaped plastic tip.

Modelos Models	Medidas Measures	
1851	10x20 mm.	Und. x50
1852	10x25 mm.	
1853	15x20 mm.	
1854	15x25 mm.	
1855	15x30 mm.	
1856	20x30 mm.	
1857	20x35 mm.	
1858	20x40 mm.	
1859	20x50 mm.	
1860	30x40 mm.	
1865	40x60 mm.	
1866	30x50 mm.	
1867	30x80 mm.	
1868	40x80 mm.	

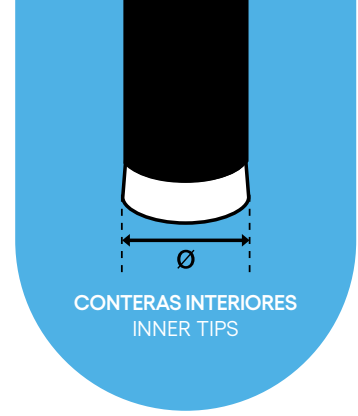

CONTERAS INTERIORES
INNER TIPS



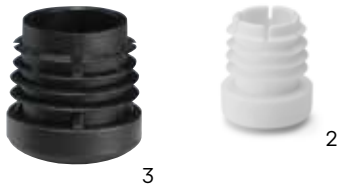

Contera interior redonda de plástico.
Inner round-shaped plastic tip.

Modelos Models	Medidas Measures	
1416*	Ø16 mm.	Und. x50
1418	Ø18 mm.	
1420	Ø20 mm.	4 x10 Und. x50
1422	Ø22 mm.	
1425	Ø25 mm.	
1428	Ø28 mm.	
1430	Ø30 mm.	Und. x50
1432*	Ø32 mm.	
1435*	Ø35 mm.	
1443*	Ø40 mm.	
1444*	Ø45 mm.	
1450*	Ø50 mm.	Und. x100
1446*	Ø60 mm.	

*Disponibles sólo en color negro.
*Available only in black color.

Conteras especiales. Special tips.



1878

Contera doble alojamiento.
Double tip.

Modelos Models	Medidas Measures	
1876	Ø16 mm.	Und. x50
1878	Ø18 mm.	

1870

Contera abrazadera circular para tubo de Ø22-25 mm.
Round clamp tip for tube of Ø 22-25 mm.

Medidas producto
Product measures
26x26x23 mm.

Und. x50



1871

Contera abrazadera longitudinal para tubo de Ø22-25 mm.
Longitudinal clamp tip for tube of Ø22-25 mm.

Medidas producto
Product measures
20x20x93 mm.

Und. x50



3



Pie nivelador.
Levelling leg.

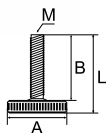

Modelos Models	Medidas Measures	
1071	AØ30 x L41mm. (M10 x B33mm.)	Und.  x25
1073	AØ30 x L47mm. (M8 x B40mm.)	
1075	AØ40 x L53mm. (M10 x B46mm.)	
1076	AØ40 x L56mm. (M8 x B45mm.)	



Pomo con espiga.
Screw knob.

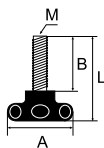

Modelos Models	Medidas Measures	
1078	AØ30 x L40mm. (M6 x B22mm.)	Und.  x25
1079	AØ40 x L55mm. (M8 x B32mm.)	
1080	AØ50 x L60mm. (M10 x B37mm.)	
1081	AØ60 x L70mm. (M10 x B37mm.)	



Pomo con espiga.
Screw knob.

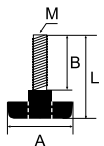

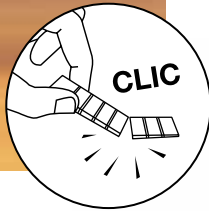

Modelos Models	Medidas Measures	
1082	AØ70 x L62mm. (M10 x B33mm.)	Und.  x25



3013

Cuña niveladora.
Levelling wedge.

Medidas producto
Product measures
9x21x101 mm.

 4  x6





0



3010

Cuña de madera para muebles.
Wooden furniture wedge.

Medidas producto
Product measures
12x20x73 mm.

 3  x10



8



3

1050

Pinza sujeta-zócalos para tubo de Ø30-35 mm.
Socle clamp for tube of Ø30-35 mm.

Medidas producto
Product measures
16x33x34 mm.

Und.  x50

3012

Cuña de plástico para muebles.
Plastic furniture wedge.

Medidas producto
Product measures
12x20x72 mm.

 3  x10



0



4

ELEMENTOS DE FIJACIÓN PARA CABLE ELÉCTRICO

ELECTRIC WIRE
SUPPORT

Canaleta
Cable duct

105

Accesorios canaleta
Joints for cable duct

110

Cablefix
Cablefix

112

Accesorios cablefix
Joints for Cablefix

115

Tapacables
Cable cover

116

Gadgets para cables
Gadgets for cables

117



CANALETA PARA CABLE ELÉCTRICO

CABLE DUCT

CARACTERÍSTICAS TÉCNICAS:

- **CE** Marcado CE conforme al RBT (Reglamento Baja Tensión).
- Cumple Directiva Europea sobre el NO uso de sustancias peligrosas (ROHS).
- Conforme normas UNE-EN-50085-1:2006 y UNE-EN-50085-2-1:2008, y directivas 73/23 CEE y 93/68 CEE.
- Temperatura de servicio -5°C, +60°C.
- Protección contra impactos IPXX3 (canaletas con tapa incorporada).
- Protección contra impactos IPXX5 (canaletas con tapa independiente).
- Grado de protección IP40 (en todos los modelos).
- Colores: Blanco RAL 9003 – Decorado: roble, cerezo, sapelly, gris metalizado y negro.
- Gama de accesorios de enlace disponibles para los diferentes acabados.

TECHNICAL SPECIFICATIONS:

- **CE** mark conforming to LVD (Low Voltage Directive).
- It complies with the European Restriction of the Use of Certain Hazardous Substances (ROHS).
- It meets UNE-EN-50085-1:2006 and UNE-EN-50085-2-1:2008, and directives 73/23 CEE – 93/68 CEE.
- Service temperature -5°C, +60°C.
- Impact protection IPXX3 (cable duct with incorporated cover).
- Impact protection IPXX5 (cable duct with independent cover).
- Protection degree IP40 (in all models).
- Colours: White RAL 9003 – Decorated: oak, cherry tree, sapelly, metallic grey and black.
- Range of linking accessories available for different finishes.

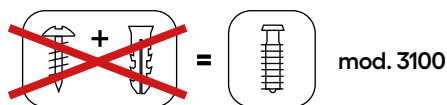

Fijación con taco mod.3100 de material aislante de poliamida. Sustituye tornillo y taco convencional.
Fixation with plug mod.3100 made of polyamide insulation material. It substitutes the conventional screw and plug.

FIJACIÓN
CON TACO
FIXATION
WITH PLUG

Fijación con adhesivo de espuma de 1mm de grosor.

Fixation by self-adhesive foam 1mm thickness.

FIJACIÓN
ADHESIVA
ADHESIVE
FIXATION



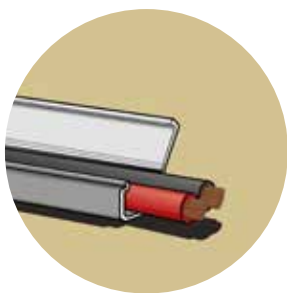

Canaleta con tapa bisagra.

Cable duct with hinge cover.

9x5 mm

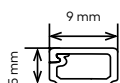

Medidas producto
Product measures
ℓ 2 m

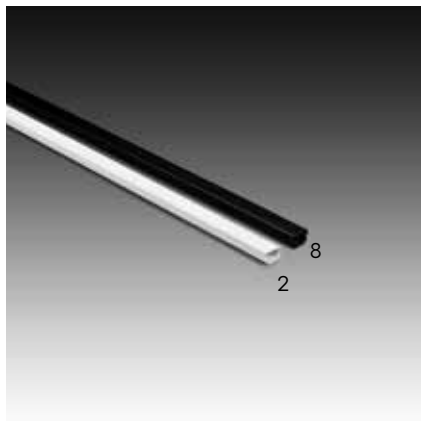

2405

Canaleta adhesiva con tapa bisagra.
Adhesive cable duct with hinge cover.



x20

12x7 mm

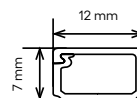

Medidas producto
Product measures
ℓ 2 m



2406

Canaleta adhesiva con tapa bisagra.
Adhesive cable duct with hinge cover.



x20

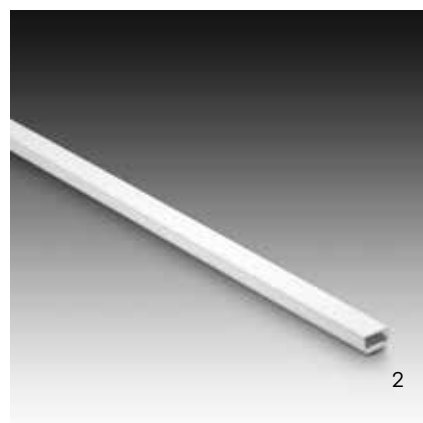

3401

Canaleta tapa bisagra
(fijación con tornillos).
Cable duct with hinge cover
(screw-fastening).



x20

16x10 mm

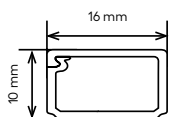

Medidas producto
Product measures
ℓ 2 m

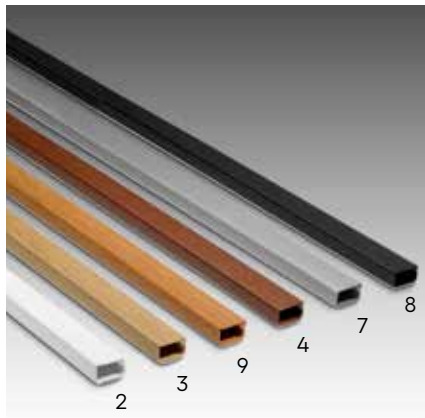

2407

Canaleta adhesiva con tapa bisagra.
Adhesive cable duct
with hinge cover.



3402

Canaleta tapa bisagra
(fijación con tornillos).
Cable duct with hinge
cover (screw-fastening).



21x11,5 mm

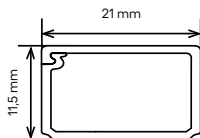

Medidas producto
Product measures
ℓ 2 m

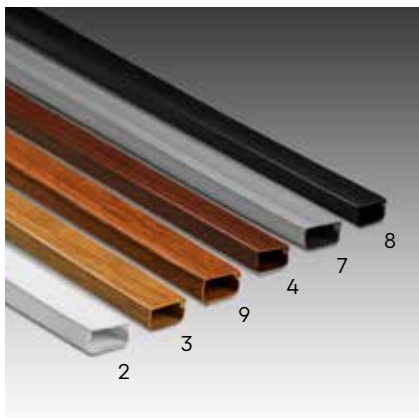

2408

Canaleta adhesiva con tapa bisagra.
Adhesive cable duct
with hinge cover.



3403

Canaleta tapa bisagra
(fijación con tornillos).
Cable duct with hinge
cover (screw-fastening).



30x11,5 mm

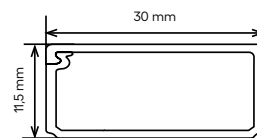

Medidas producto
Product measures
ℓ 2 m



3404

Canaleta tapa bisagra
(fijación con tornillos).
Cable duct with hinge
cover (screw-fastening).



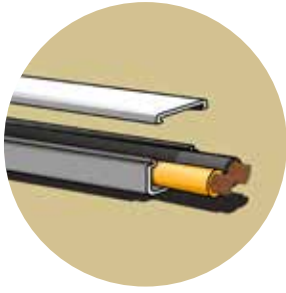

Canaleta con tapa extraíble.

Cable duct with extraction cover.

16x10 mm

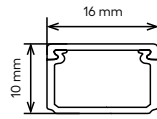

Medidas producto
Product measures
ℓ 2 m

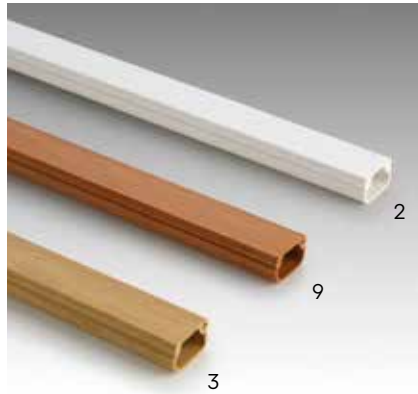

2600

Canaleta adhesiva con tapa extraíble.
Adhesive cable duct with extraction cover.



x20



2



3600

Canaleta con tapa extraíble
(fijación con tornillos).
Cable duct with extraction cover
(screw-fastening).



x20

16x16 mm

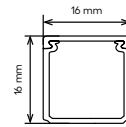

Medidas producto
Product measures
ℓ 2 m



2



2601

Canaleta adhesiva con tapa extraíble.
Adhesive cable duct with extraction cover.



x20

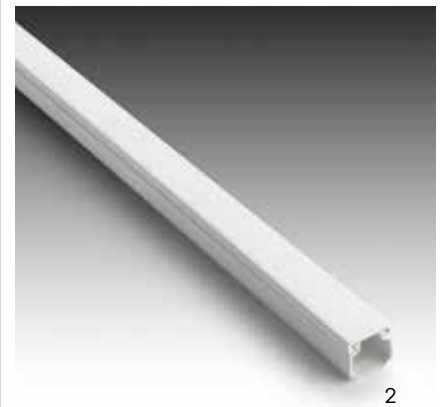

2



3601

Canaleta con tapa extraíble
(fijación con tornillos).
Cable duct with extraction cover
(screw-fastening).



x20

25x16 mm

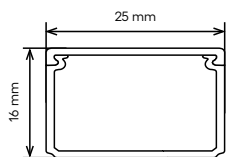

Medidas producto
Product measures
ℓ 2 m



2602

Canaleta adhesiva con tapa extraíble.
Adhesive cable duct with extraction cover.



3602

Canaleta con tapa extraíble (fijación con tornillos).
Cable duct with extraction cover (screw-fastening).



35x16 mm

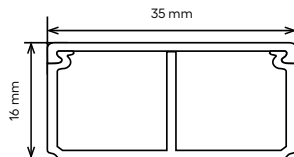

Medidas producto
Product measures
ℓ 2 m



3603

Canaleta con tapa extraíble (fijación con tornillos).
Cable duct with extraction cover (screw-fastening).



53x20 mm

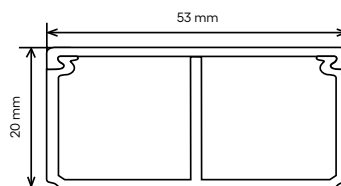

Medidas producto
Product measures
ℓ 2 m

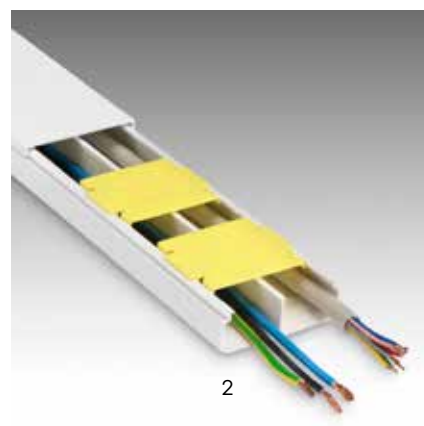

3604

Canaleta con tapa extraíble (fijación con tornillos).
Cable duct with extraction cover (screw-fastening).



Accesorios para canaleta.

Cable duct
accessories.

Consulta en la tabla el color y modelos disponibles para cada tamaño.

Check the table for the colours and models available for each size.

Para canaleta...
For cable duct...

	9x5	12x7	16x10	16x16	21x11,5	25x16	30x11,5	35x16
	3390 	3410 	3420 	3610 	3430 	3620 	3440 	3630
	3391 	3411 	3421 	3611 	3431 	3621 	3441 	3631
	3392 	3412 	3422 	3612 	3432 	3622 	3442 	3632
	3393 	3413 	3423 	3613 	3433 	3623 	3443 	3633
	3394 	3414 	3424 	3614 	3434 	3624 	3444 	3634
	3395 	3415 	3425 	3615 	3435 	3625 	3445 	3635
	--	3100						

2 Blanco
White

7 Gris metalizado
Silver grey

8 Negro
Black

3 Roble
Oak

9 Cerezo
Cherry tree

4 Sapelly
Sapelly

Cablefix

Soporte adhesivo para cable eléctrico.

Adhesive support
for electric cable.

ELEMENTOS DE FIJACIÓN PARA CABLE ELÉCTRICO - CABLEFIX
ELECTRIC WIRE SUPPORTS - CABLEFIX

112



CARACTERÍSTICAS TÉCNICAS:

- Base rígida y laterales flexibles envolventes.
- Cumple Directiva Europea 2002/95/EC sobre el NO uso de sustancias peligrosas (ROHS).
- Material aislante y auto-extinguible. Cumple la norma UNE-EN-60695.
- Temperatura de servicio -5°C, +60°C.
- Colores: Blanco RAL 9010, Marrón RAL 8028, Negro, Gris Metalizado y Beige.
- Gama de accesorios de enlace disponibles para los diferentes acabados.

TECHNICAL SPECIFICATIONS:

- Rigid base with flexible, wrapping sides.
- It complies with the European Restriction 2002/95/EC of the Use of Certain Hazardous Substances (ROHS).
- Insulating and self extinguishing material: It meets the standard UNE EN 60695.
- Service temperature -5°C, +60°C
- Colors: White RAL 9010, Brown RAL 8028, Black, Metallic Grey and Beige.
- Range of linking accessories available for different finishes.



CABLEFIX facilita la fijación de cable eléctrico, dejando un acabado perfecto. Las aletas flexibles permiten colocar y extraer el cable con gran facilidad.

CABLEFIX allows easy attachment of electric cables with an excellent appearance. Flexible wings allow installing and removing cable very easily.



FIJACIÓN ADHESIVA
ADHESIVE FIXATION

Por su flexibilidad se adapta sobre superficies no rigurosamente planas.

Its flexibility enables installation on uneven surfaces.



No necesita herramientas. Se corta fácilmente con unas tijeras.

No tool required. Can be cut with scissors.

 Video / Video:



Gama CABLEFIX.

CABLEFIX range.

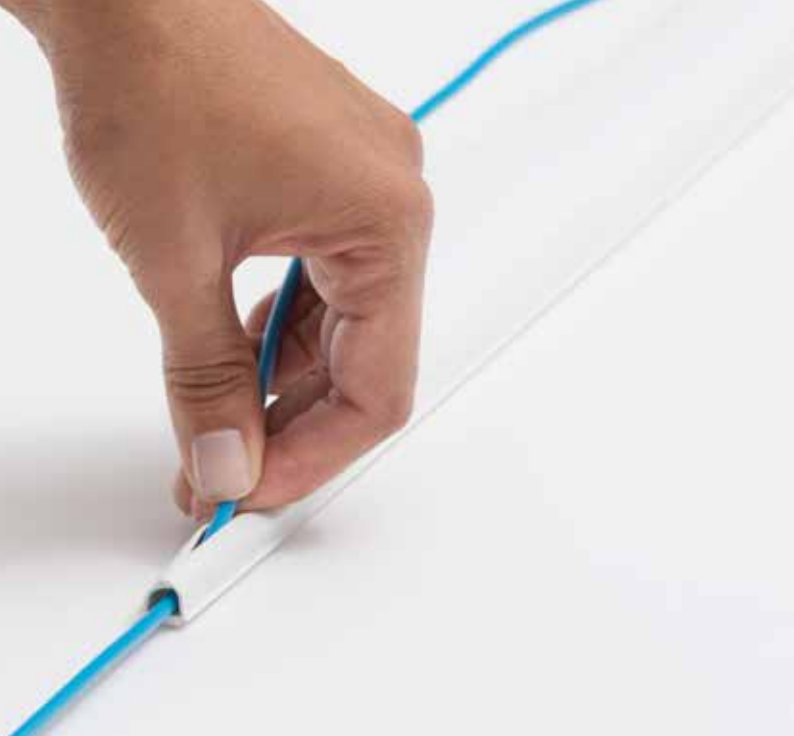

2200

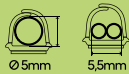

5,5x5 mm

Medidas producto
Product measures
ℓ 1 m



2200

Soporte adhesivo para cable eléctrico.
Adhesive support for electric cable.



2201

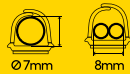

8x7 mm

Medidas producto
Product measures
ℓ 1 m

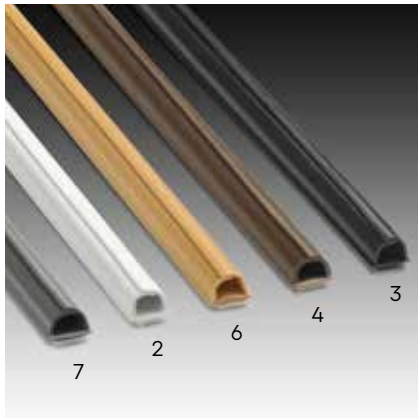

2201

Soporte adhesivo para cable eléctrico.
Adhesive support for electric cable.

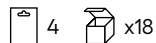

2202

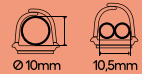

10,5x10 mm

Medidas producto
Product measures
ℓ 1 m



2202

Soporte adhesivo para cable eléctrico.
Adhesive support for electric cable.

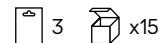

Accesorios para Cablefix.

Cablefix accessories.



Consulta en la tabla el color y modelos disponibles para cada tamaño.

Check the table for the available colours and models for each size.

Para Cablefix...
For Cablefix...

	2200 5,5x5 mm.	2201 8x7 mm.	2202 10,5x10 mm.
	3200 ○ ● ●	3210 ○ ○ ● ● ●	3220 ○ ○ ● ● ●
	3201 ○ ● ●	3211 ○ ○ ● ● ●	3221 ○ ○ ● ● ●
	3202 ○ ●	3212 ○ ○ ● ●	3222 ○ ○ ●
	3203 ○ ●	3213 ○ ○ ● ●	3223 ○ ○ ●
	3204 ○ ●	3214 ○ ○ ● ●	3224 ○ ○ ●
	3205 ○ ●	3215 ○ ○ ● ●	3225 ○ ○ ●

2 Blanco
White

7 Gris
Grey

3 Negro
Black

4 Marrón
Brown

6 Beige
Beige



¿Por qué dejarlos a la vista?

Why leave them on show?



2130

Tapacables metálico adhesivo.
Adhesive metal cable cover.

Medidas producto
Product measures
£ 1m.



Perfil / Section

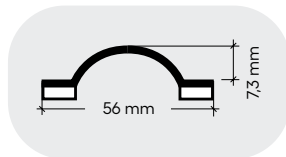

3130

Tapacables metálico con tornillos incluidos.
Metal cable cover with screws included.

Medidas producto
Product measures
£ 1m.



Perfil / Section

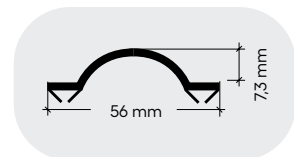



Gadgets para cables.

Gadgets for cables.

Gadgets para cable.

Gadgets for cables.



7000

Identificador de cables.
Cable tag.

Medidas producto
Product measures
3x15x25 mm.



0



7001

Protector para cable USB y microUSB.

Spiral protector for USB and micro-USB cables.

Medidas producto
Product measures
9x9x41mm.

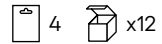

7002

Bridas textiles para cables.
Fabric cable ties.

Medidas producto
Product measures
1x20x200 mm.

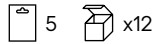

0



7004

Malla agrupadora de cables 1,5m.

1,5 m. Braided cable sleeving.

Medidas producto
Product measures
2x82x1500 mm.



3



7005

Bridas reutilizables Magic Tie 15cm.
Magic Tie 15cm reusable cable ties.

Medidas producto
Product measures
6x6x150 mm.



0



7006

Bridas reutilizables Magic Tie 25cm.
Magic Tie 25cm reusable cable ties.

Medidas producto
Product measures
6x6x250 mm.

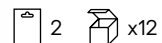

0



7100

Mini Clip adhesivo para cables.
Mini adhesive cable clip organiser.

Medidas producto
Product measures
12x20x20 mm.

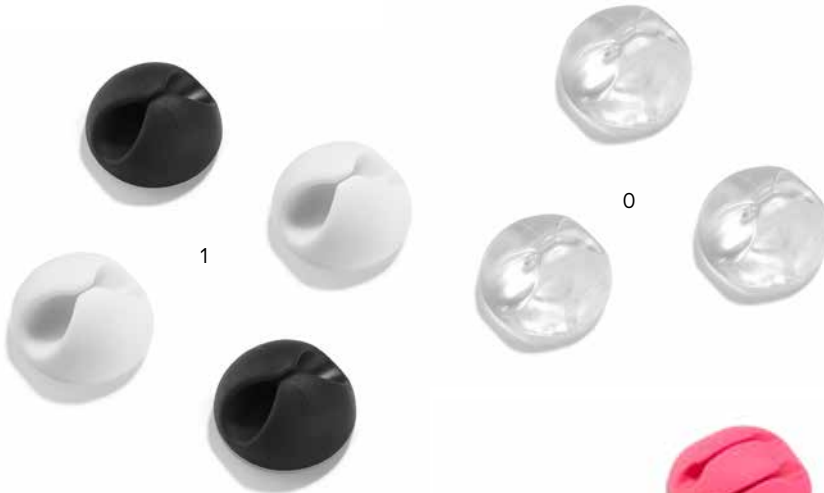
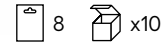

7101

Mini Clip adhesivo para cables.
Adhesive cable clip organiser.

Medidas producto
Product measures
15x29x29 mm.

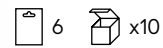

7102

Clip adhesivo doble para cables.
Double adhesive cable clip organiser.

Medidas producto
Product measures
12x35x35 mm.

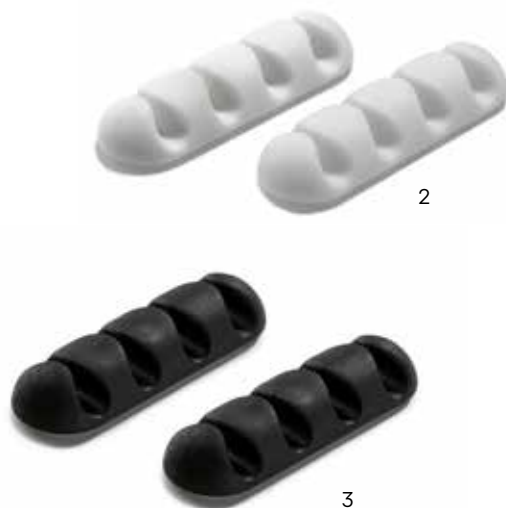
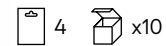

7103

Clip adhesivo múltiple para cables.
Multiple adhesive cable clip organiser.

Medidas producto
Product measures
12x65x21 mm.

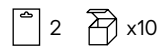

7107

Clip para cables triple.
Triple cable clip.

Medidas producto
Product measures
60x34x56 mm.



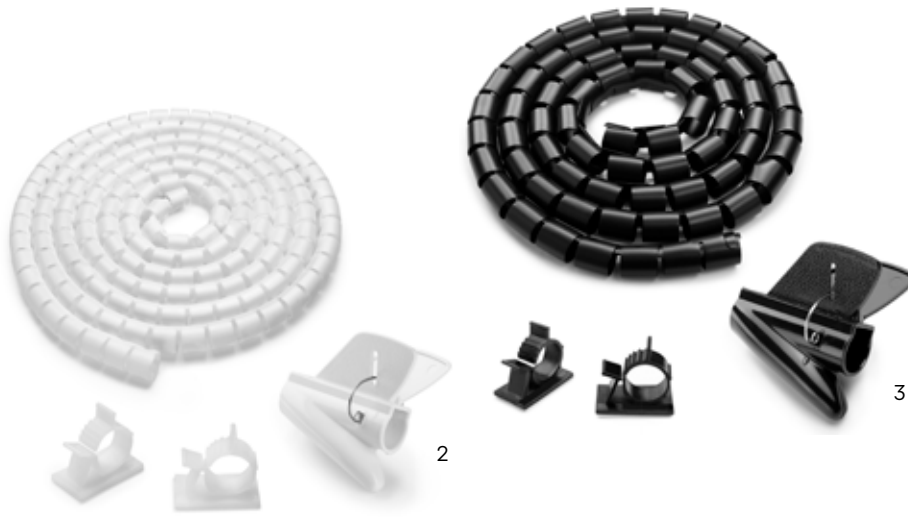

7003

Agrupador de cables flexible 3m.
3 m. Flexible cable bundler.

Medidas producto
Product measures
20x20x3000 mm.

1 x6

3



7500

Soporte adhesivo para enchufe.
Adhesive plug holder.

Medidas producto
Product measures
70x53x28 mm.

2 x10

2



7200

Raspa recogedora de cables.
Fishbone cable organiser.

Medidas producto
Product measures
7x75x34 mm.

3 x12

0



3

7300

Soportes para ordenador portátil.
Laptop feet.

Medidas producto
Product measures
Ø 4,5 cm (grandi)
Ø 3,5cm (piccoli)

4 x12



CINTAS Y ADHESIVOS

TAPES AND ADHESIVES

Cintas y adhesivos de fijación
Fixing tapes and adhesives

123

Cintas y adhesivos de reparación
Repair tapes and adhesives

128

Cintas y adhesivos antideslizantes
Non-slip tapes and adhesives

130

Cintas y adhesivos de aislamiento
Insulation tapes and adhesives

131

Cintas y adhesivos de sujeción
Grip tapes and adhesives

132



Cinta para manualidades.

Handicrafts tape.



Double Sided SCRAPBOOKING

1
Kg*/cm²



FÁCIL DE CORTAR
EASY TO CUT

2141

Cinta adhesiva doble cara. Ideal para realizar todo tipo de manualidades al ser muy fina y poderse cortar con los dedos con gran facilidad sin necesidad de tijeras o cuchillas.

Two-sided adhesive tape. Ideal for all kinds of handicrafts, as it is very thin and can be cut easily with your fingers without the need to use scissors or cutters.

Medidas producto
Product measures
19mm. x 5m.

📦 1 📦 x14

Water Resistant.

4
Kg*/cm²

water resistant

🌡️ -25° / 80°

🏠 INTERIOR / EXTERIOR
INDOOR / OUTDOOR

💧 RESISTENTE A LA HUMEDAD
MOISTURE RESISTANT

🕒 ADHESIVO/ADHESIVE
INSTANT



2142

Cinta adhesiva doble cara resistente al agua. Especialmente diseñada para soportar ambientes cálidos y húmedos, así como el contacto directo con el agua.

Two-sided adhesive tape with reinforced mesh. Specially designed to withstand hot and humid environments, as well as direct contact with water.

Medidas producto
Product measures
19mm. x 1,5m.

📦 1 📦 x14



Double Sided
WATER RESISTANT

¡Cinta con malla de refuerzo!

Tape with reinforced mesh!

Double Sided INSTANT TAPE



FÁCIL DE CORTAR
EASY TO CUT

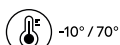

USO INTERIOR
INDOOR USE

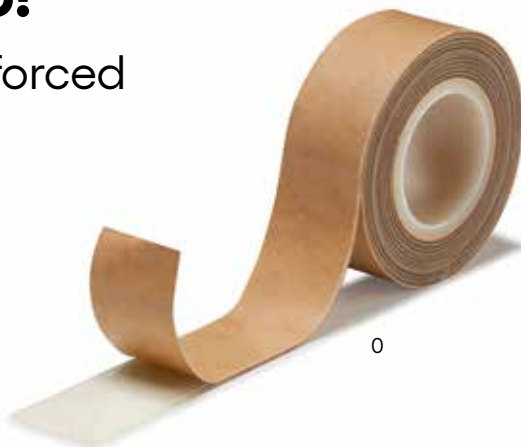

1976

Cinta adhesiva doble cara transparente con malla reforzada. Extrema resistencia, sujeción extrafuerte. Apta para usos de interior.

Two-sided adhesive tape with reinforced mesh. Extreme strength, extra strong hold. Suitable for indoor and outdoor use.

Medidas producto
Product measures
19mm. x 1,5m.

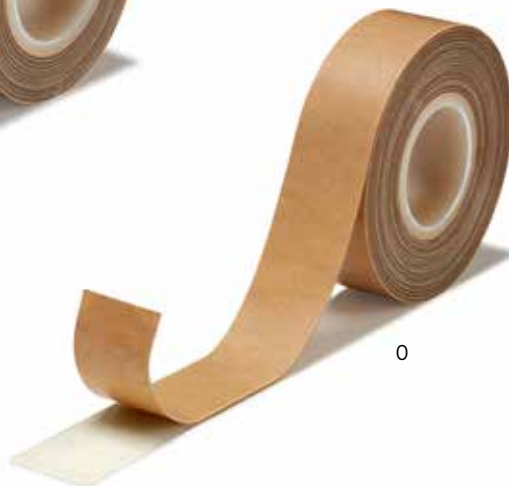

1977

Cinta adhesiva doble cara transparente con malla reforzada. Extrema resistencia, sujeción extrafuerte. Apta para usos de interior.

Two-sided adhesive tape with reinforced mesh. Extreme strength, extra strong hold. Suitable for indoor and outdoor use.

Medidas producto
Product measures
19mm. x 2,5m.



Double Sided ULTRA STRONG

1,3
kg*/cm²

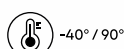

INTERIOR / EXTERIOR
INDOOR / OUTDOOR

RESISTENTE RAYOS UV
UV RESISTANT

1996

Cinta adhesiva doble cara para exteriores. Excelente resistencia al envejecimiento, humedad, agua y radiación UV. Alto grado de adhesividad inicial. Operativa a altas temperaturas (hasta 80°C).

Outdoors double sided adhesive tape. Excellent resistance to ageing, humidity, water, and UV rays. High degree of initial adhesiveness. Operational at high temperature (up to 80°C).

Medidas producto
Product measures
19mm. x 1,5m.





Cintas adhesivas doble cara. Un buen adhesivo... ¡En ambas caras!

Double sided adhesive tapes.
A good adhesive...
On both sides!

**Double Sided
UNIVERSAL**

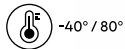

2007

Medidas producto
Product measures
15mm. x 15m.



2

2000

Medidas producto
Product measures
15mm. x 1,5m.



2

2001

Medidas producto
Product measures
15mm. x 75cm.



2

2008

Medidas producto
Product measures
25mm. x 15m.

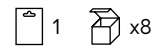

2

2005

Medidas producto
Product measures
15mm. x 2,5m.



2

2006

Medidas producto
Product measures
25mm. x 2,5m.



2

2002

Plaquitas de cinta
adhesiva doble cara.
Two-sided adhesive
tape strips.

Medidas producto
Product measures
30 x 13mm.

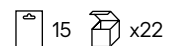

2

(*) DIN EN 1943

Magnética.

Magnetic.



3

1970

Cinta magnética adhesiva.
Fuerza magnética de 47 g/cm².
Se puede cortar fácilmente con tijeras o con un cúter.
Temperatura de servicio -20°C a 80°C.
Adhesive magnetic tape.
Magnetic force of 47 g/cm².
It can be easily cut with scissors or a cutter.
Operating temperature: -20°C to 80°C.

Medidas producto
Product measures
19mm. x 1m.



1971

Lámina magnética autoadhesiva.
Fuerza magnética de 24 g/cm².
Se puede cortar fácilmente con tijeras o con un cúter.
Temperatura de servicio -20°C a 80°C.
Self-adhesive magnetic sheet.
Magnetic force of 24 g/cm².
It can be easily cut with scissors or a cutter.
Operating temperature: -20°C to 80°C.

Medidas producto
Product measures
100 x 85 mm.



3

Cinta fijación moquetas.

Carpets fixing tape.

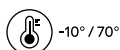

1980

Cinta adhesiva 2 caras para moqueta.
Two-sided adhesive tape for carpets and rugs.

Medidas producto
Product measures
50mm. x 5m.



2



1981

Cinta adhesiva 2 caras para moqueta.
Two-sided adhesive tape for carpets and rugs.

Medidas producto
Product measures
50mm. x 25m.



2



Adhesivo acrílico. ¡Resiste temperaturas extremas!

Acrylic adhesive.

Resists extreme temperatures!

Double Sided EXTRA STRONG RED RIBBON

TRANSPARENTE
TRANSPARENT



INTERIOR / EXTERIOR
INDOOR / OUTDOOR



-40° / 150°

2140

Plaquitas de cinta adhesiva doble cara. Apta para usos de interior y exterior. Two-sided adhesive tape strips. Suitable for indoor and outdoor use.

Medidas producto
Product measures
30 x 13mm.

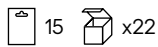

0

Double Sided EXTRA STRONG RED RIBBON

TRANSPARENTE
TRANSPARENT



INTERIOR / EXTERIOR
INDOOR / OUTDOOR



-40° / 150°

1997

Cinta adhesiva doble cara transparente y muy resistente. Apta para usos de interior y exterior. Two-sided transparent and high-resistance adhesive tape. Suitable for indoor and outdoor use.

Medidas producto
Product measures
19mm. x 1,5m.



2

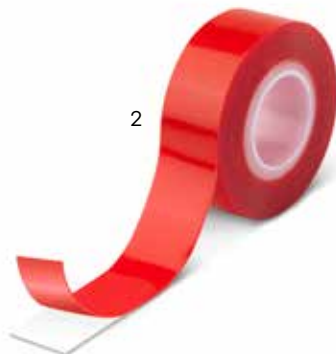

1998

Cinta adhesiva doble cara transparente y muy resistente. Apta para usos de interior y exterior. Two-sided transparent and high-resistance adhesive tape. Suitable for indoor and outdoor use.

Medidas producto
Product measures
19mm. x 2,5m.



2

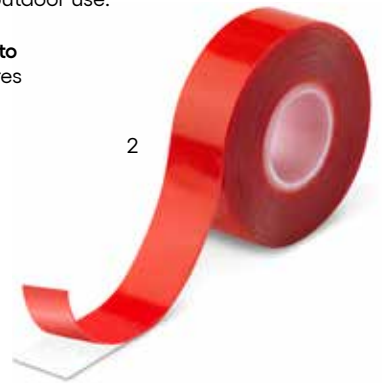

Limpio y seguro. Masilla adhesiva removible multi usos.

Clean and safe.
Multipurpose removable
adhesive putty.



8

1994

Masilla adhesiva removible.
Adhesive removable putty.

Cantidad producto
Amount of product
50gr.

 1  x48



Triple capa.

Triple layer.

1 Polietileno / polyethylene

2 Soporte téxtil / Textile support

3 Adhesivo / Adhesive

1983

Cinta americana textil.
Cloth adhesive tape.

Medidas producto
Product measures
25mm. x 10m.

 1  x10

1984

Cinta americana textil.
Cloth adhesive tape.

Medidas producto
Product measures
50mm. x 10m.

 1  x4

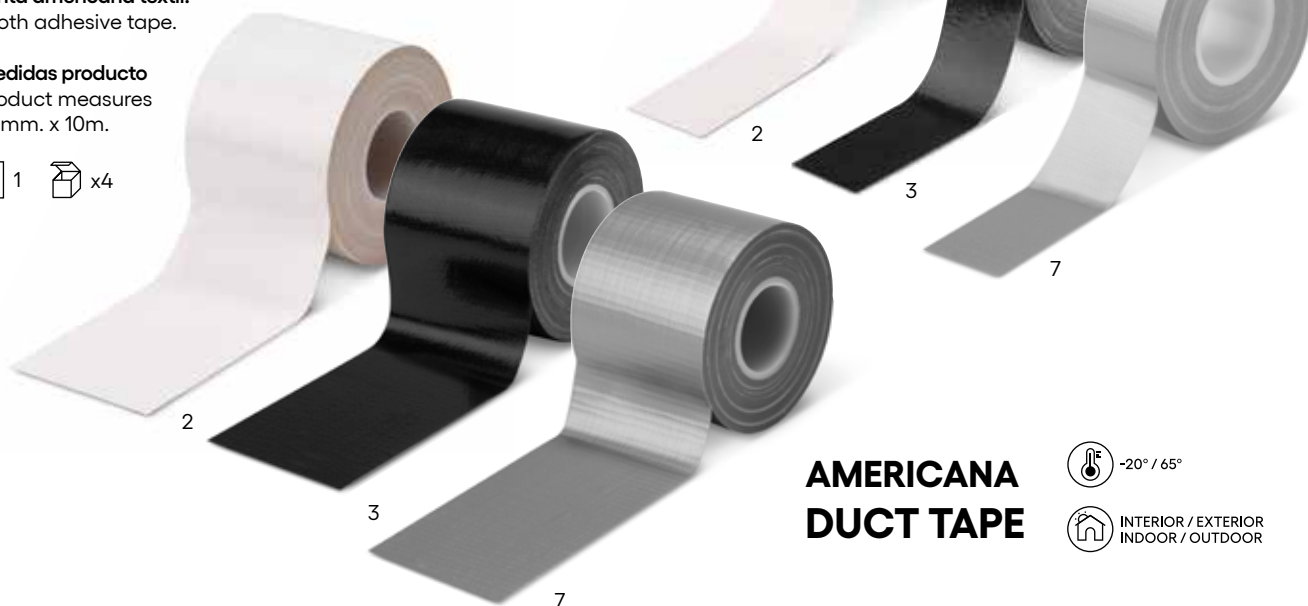

**AMERICANA
DUCT TAPE**

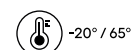



Cinta adhesiva de aluminio. ¡Resiste temperaturas extremas!

Aluminum adhesive tape.

Resists extreme temperatures!

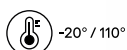

-20° / 110°



INTERIOR / EXTERIOR
INDOOR / OUTDOOR



1

2

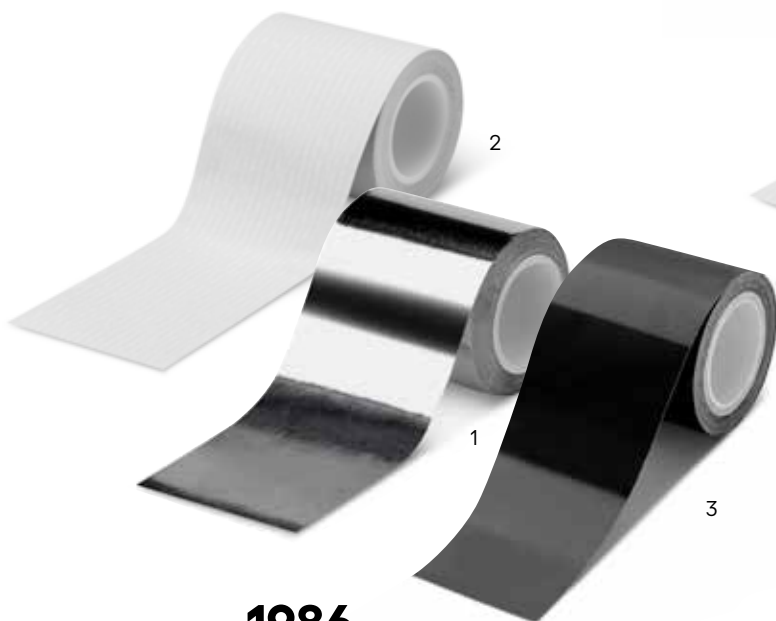

2

1

3

1986

Cinta adhesiva de aluminio.
Temperatura de servicio:
 -20°C a 110°C (aplicación
 entre 15°C y 35°C).
 Aluminium adhesive tape.
 Working temperature:
 -20°C to 110°C (application
 between 15°C and 35°C).

Medidas producto
 Product measures
 50mm. x 5m.



1987

Cinta adhesiva de aluminio.
Temperatura de servicio:
 -20°C a 110°C (aplicación
 entre 15°C y 35°C).
 Aluminium adhesive tape.
 Working temperature:
 -20°C to 110°C (application
 between 15°C and 35°C).

Medidas producto
 Product measures
 50mm. x 10m.

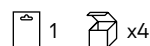

Cintas adhesivas antiresbalones. Especiales para la seguridad.

Non-slip safety adhesive tapes.



ANTI-RESBALONES ANTI-SLIP

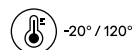

1988

Cinta adhesiva antiresbalones.
Non-slip adhesive tape.

Medidas producto
Product measures
25mm. x 15m.



1989

Cinta adhesiva antiresbalones.
Non-slip adhesive tape.

Medidas producto
Product measures
25mm. x 5m.

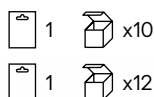

1990

Cinta adhesiva antiresbalones.
Non-slip adhesive tape.

Medidas producto
Product measures
50mm. x 5m.



1991

Cinta adhesiva antiresbalones especial para suelos mojados.
Special non-slip adhesive tape for wet floors.

Medidas producto
Product measures
25mm. x 5m.



water resistant

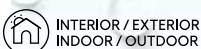
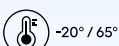

SEMITRASPARENTE
SEMITRASPARENT

0

1992

Discos adhesivos antiresbalones especial duchas y bañeras.
Special non-slip adhesive discs for showers and baths.

Medidas producto
Product measures
Ø38 mm.

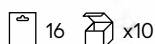

water resistant



SEMITRASPARENTE
SEMITRASPARENT

0

Cinta autosoldable.

Gracias a la vulcanización en 5 min. el producto formará una masa compacta impermeable y muy resistente.

Self-bonding tape.

Thanks to the vulcanisation in just 5 minutes the product will form a waterproof compact mass extremely resistant.



Aislante eléctrico.

Electrical insulation.



1995

Cinta autosoldable.
Aislante eléctrica y sellante de escapes de agua.
Self-bonding tape.
Electrical insulation and water sealant.

Medidas producto
Product measures
19mm. x 3m.

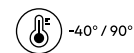
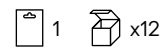

Sellante de fugas y escapes de agua.

Water sealant.



HOOK & LOOP



2143

Tiras adhesivas de cierre de gancho y bucle.
Adhesive hook-and-loop fastener strips.

Medidas producto
Product measures
20mm x 10cm.

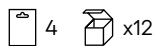

2

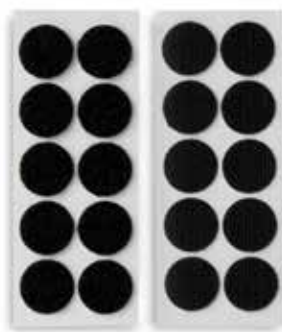

3

2146

Discos adhesivos de cierre de gancho y bucle.
Adhesive hook-and-loop fastener discs.

Medidas producto
Product measures
Ø20mm.

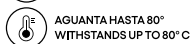
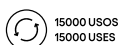
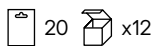

5

3

2009

Cinta autoadherente reutilizable.
Para organizar manojos de cables y otros objetos.
Reusable self-adhesive tape.
For tidying up bundles of cables and other objects.

Medidas producto
Product measures
9mm. x 3m.





2144

Rollo adhesivo de cierre de gancho y bucle.
Adhesive hook-and-loop fastener roll.

Medidas producto
Product measures
20mm x 1,5m.

1 x10

- ADHESIVO
ADHESIVE
- AGUANTA HASTA 80°
WITHSTANDS UP TO 80° C
- 15000 USOS
15000 USES



2

3

ESPECIAL TEXTIL SPECIAL TEXTILE

2145

Rollo adhesivo de cierre de gancho y bucle.
Adhesive hook-and-loop fastener roll.

Medidas producto
Product measures
20mm x 1,5m.

1 x10

- ADHESIVO PLANCHADO
IRON-ON ADHESIVE
- 15000 USOS
15000 USES



2

3



SEGURIDAD INFANTIL EN EL HOGAR

CHILD SAFETY
AT HOME

Mobiliario
Furniture

135

Puertas y ventanas
Doors and windows

143

Baño
Bathroom

146

Electricidad
Electricity

148

Coche y paseo
Car & Walking

149



Consulta
el video para
esta categoría:

Check the
video for this
category:





PROTECTORES DE GOLPES

IMPACT PROTECTORS



5000

Protector de cantos. Fijación adhesiva.
Corner Guard. Adhesive fastening.

Medidas producto
Product measures
24x43x43 mm

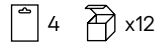

PROPIEDADES

- Material: PVC flexible y transparente, no tóxico.
- Protege de daños accidentales por colisión.
- Aplicable en mesas, sillas y otro mobiliario con cantos peligrosos.

FEATURES

- Material: Flexible, transparent PVC, nontoxic.
- Protects against accidental injuries from collisions.
- Can be used on tables, chairs and other furniture with sharp corners.



5001

Protector de cantos. Fijación adhesiva.
Corner Guard. Adhesive fastening.

Medidas producto
Product measures
20x34x25 mm

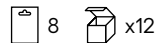

PROPIEDADES

- Material: PVC flexible y transparente, no tóxico.
- Protege de daños accidentales por colisión.
- Aplicable en mesas, sillas y otro mobiliario con cantos peligrosos.

FEATURES

- Material: Flexible, transparent PVC, nontoxic.
- Protects against accidental injuries from collisions.
- Can be used on tables, chairs and other furniture with sharp corners.



5002

Protector de cantos acolchado. Fijación adhesiva.
Padded Corner Guard. Adhesive fastening.

Medidas producto
Product measures
24x52x52 mm



PROPIEDADES

- Material: Caucho de espuma flexible, sin látex ni agentes tóxicos.
- Protege de daños accidentales por colisión.
- Aplicable en mesas, sillas y otro mobiliario con cantos peligrosos.

FEATURES

- Material: Nontoxic and latex-free flexible foam rubber.
- Protects against accidental injuries from collisions.
- Can be used on tables, chairs and other furniture with sharp corners.

5003

Rollo protector de cantos acolchado (2m).
Fijación adhesiva.
Padded Edge Guard (2m roll).
Adhesive fastening.

Medidas producto
Product measures
26x2000x26 mm



PROPIEDADES

- Material: Caucho de espuma flexible, sin látex ni agentes tóxicos.
- Protege de daños accidentales por colisión.
- Aplicable en mesas, sillas y otro mobiliario con cantos peligrosos.

FEATURES

- Material: Nontoxic and latex-free flexible foam rubber.
- Protects against accidental injuries from collisions.
- Can be used on tables, chairs and other furniture with sharp corners.





5004

Rollo protector de cantos acolchado (2m)
+ 4 esquineras. Fijación adhesiva.

Padded Edge Guard (2 m roll) + 4 Corner Guards.
Adhesive fastening.

Medidas producto
Product measures
13x2000x13 mm



PROPIEDADES

- Material: Caucho de espuma flexible, sin látex ni agentes tóxicos.
- Protege de daños accidentales por colisión.
- Aplicable en mesas, sillas y otro mobiliario con cantos peligrosos.

FEATURES

- Material: Nontoxic and latex-free flexible foam rubber.
- Protects against accidental injuries from collisions.
- Can be used on tables, chairs and other furniture with sharp corners.

5110

Protector adhesivo acolchado para cantos y paredes.
Adhesive padded edge and wall guard.

Medidas producto
Product measures
1000x120x10 mm



PROPIEDADES

- Doble función:
 - > Puede ser colocado en las esquinas de paredes y columnas para proteger de posibles golpes.
 - > También se puede instalar en plano para evitar rozaduras y golpes contra la pared.
- Fácil instalación ya que no requiere de herramientas y se puede cortar fácilmente con tijeras.
- Incorpora un hendidado vertical para facilitar más su doblado e instalación en las esquinas.
- Permite la aplicación de una capa de pintura para que quede integrado con el color de la pared y pasar así más desapercibido.

FEATURES

- Double function:
 - > It can be placed on wall and column corners to protect them from bumps.
 - > It can also be installed flat on the wall to avoid scratches and bumps.
- Easy installation, no tools required. It can be easily cut with scissors.
- It incorporates a vertical creasing that facilitates its folding and installation on corners.
- A layer of paint can be applied to integrate it with the wall colour and thus go unnoticed.

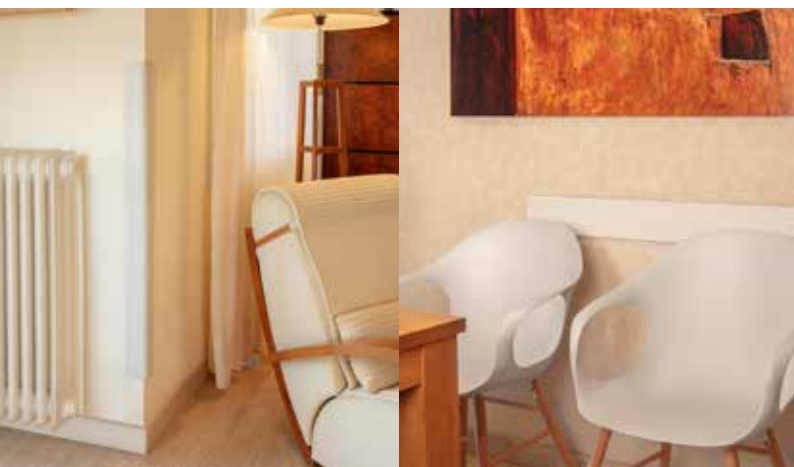



Pequeños exploradores a salvo

Little explorers out
of harm's way



CIERRES DE SEGURIDAD PARA MUEBLES

SAFETY CATCHES FOR FURNITURE



5100

Cierre de seguridad multiuso largo. Fijación adhesiva.
Long Multipurpose Safety Lock. Adhesive fastening.

Medidas producto
Product measures
36x163x13 mm

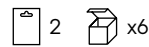

PROPIEDADES

- Impide la apertura de armarios, frigoríficos, inodoros, etc...
- Gran adaptabilidad a múltiples aparatos domésticos gracias a su correa flexible.

FEATURES

- Prevents children from opening cupboards, fridges, the bathroom, etc.
- Can easily adapt to multiple appliances thanks to its flexible strap.



5101

Cierre de seguridad multiuso corto. Fijación adhesiva.
Short Multipurpose Safety Lock. Adhesive fastening.

Medidas producto
Product measures
36x107x13 mm

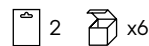

PROPIEDADES

- Impide la apertura de armarios, frigoríficos, inodoros, etc...
- Gran adaptabilidad a múltiples aparatos domésticos gracias a su correa flexible.

FEATURES

- Prevents children from opening cupboards, fridges, the bathroom, etc.
- Can easily adapt to multiple appliances thanks to its flexible strap.



5102

Cierre de seguridad multiuso ajustable.

Fijación adhesiva.

Adjustable Multipurpose Safety Lock.
Adhesive fastening.

Medidas producto

Product measures

56x210x14 mm



PROPIEDADES

- Impide la apertura de armarios, frigoríficos, inodoros, etc...
- Gran adaptabilidad a múltiples aparatos domésticos gracias a su correa flexible.

FEATURES

- Prevents children from opening cupboards, fridges, the bathroom, etc.
- Can easily adapt to multiple appliances thanks to its flexible strap.



5103

Cierre de seguridad lateral.

Fijación adhesiva.

Lateral Safety Lock.
Adhesive fastening.

Medidas producto

Product measures

41x76x76 mm



PROPIEDADES

- Impide la apertura de cajones.
- El recubrimiento de material antideslizante facilita el uso.

FEATURES

- Prevents children from opening drawers.
- The anti-slip surface makes it easy to use.





2

5104

Cierre de seguridad lateral con pestillo.
Fijación adhesiva.
Lateral Safety Lock with Latch.
Adhesive fastening.

Medidas producto
Product measures
44x83x83 mm

 1  x6

PROPIEDADES

- Impide la apertura de cajones.
- El recubrimiento de material antideslizante facilita el uso.

FEATURES

- Prevents children from opening drawers.
- The anti-slip surface makes it easy to use.





2

5105

Cierre de seguridad frontal.
Fijación adhesiva.
Exterior Safety Lock.
Adhesive fastening.

Medidas producto
Product measures
35x98x16 mm

 1  x6

PROPIEDADES

- Impide la apertura de armarios.
- Adaptable también para cajones extraíbles.

FEATURES

- Prevents children from opening cabinets.
- Can also be adapted to drawers.



2

5106

Cierre de seguridad para armarios.
Safety Slide Lock for Cabinets.

Medidas producto
Product measures
17x246x57 mm



PROPIEDADES

- Impide la apertura de armarios.
- Interior reforzado con un material blando que no daña los tiradores.
- Distancia máxima entre tiradores: 12,8cm.

FEATURES

- Prevents children from opening cabinets.
- Interior reinforced with a soft material that won't damage handles.
- Maximum distance between handles: 12.8 cm.

5107

Cierre de seguridad interno para armarios y cajones. Fijación con tornillos (incluidos).
Interior Safety Lock for Cabinets and Drawers.
Screw fastening (screws included).

Medidas producto
Product measures
48x45x85 mm



PROPIEDADES

- Impide la apertura de armarios y cajones.
- Su instalación es interna, por lo que queda oculta y no altera la estética del mobiliario.

FEATURES

- Prevents children from opening cabinets and drawers.
- It is installed on the inside of cabinets and drawers, hiding it from view and preserving the furniture's aesthetics.



2



TOPES SALVA DEDOS PARA PUERTAS

FINGER GUARD FOR DOORS



PROPIEDADES

- Evita que el niño se pille los dedos al cerrar la puerta.
- Al ser un material blando no daña la puerta.

FEATURES

- Prevents children from slamming their hands in the door.
- Its soft material won't damage doors.

5210

SURTIDO ASSORTMENT

Disponemos de caja surtida para estos productos.
Assorted boxes are available for these products.



5200

Medidas producto
Product measures
20x89x97 mm

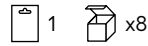

2

5211

Medidas producto
Product measures
13x100x100 mm

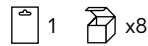

4

5212

Medidas producto
Product measures
13x97x98 mm

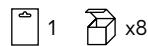

6

5213

Medidas producto
Product measures
13x100x106 mm

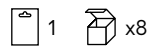

7

5214

Medidas producto
Product measures
13x97x105 mm

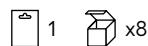

9



RETENEDOR FLEXIBLE PARA PUERTAS

DOOR FLEXIBLE RETAINER



5203

Retenedor de puerta flexible.
Flexible door holder.

Medidas producto
Product measures
38x128x36 mm

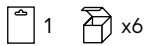

PROPIEDADES

- Flexible.
- Bloquea la puerta, impide su cierre y evita que el niño se pille los dedos.
- Evita los impactos contra la pared y los cierres violentos a causa de la acción del viento, por ejemplo.
- Los extremos de goma no dañan el suelo.
- Fácil instalación, no precisa herramientas.
- Reposicionable.

FEATURES

- Flexible.
- Blocks and keeps the door open, thus preventing children from slamming their hands.
- Prevents hitting the door against the wall or slamming it shut due to wind, for instance.
- Plastic ends do not damage the floor.
- Easy to install, no tools required.
- Can be rearranged.

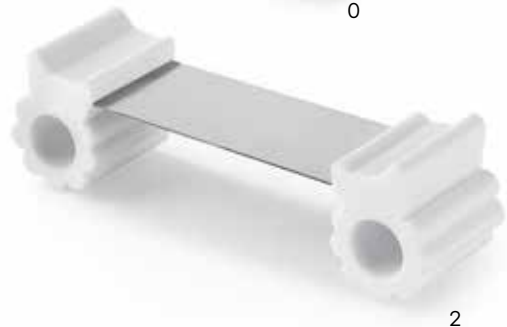
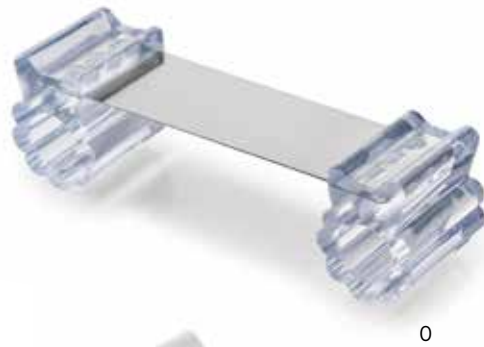



BLOQUEADOR DE SEGURIDAD PARA PUERTAS

SAFETY BLOCK FOR SLIDING DOORS

5201

Medidas producto
Product measures
25x127x14 mm

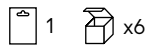

PROPIEDADES

- Limita la apertura total de puertas y ventanas correderas.
- Su forma de cuña permite adaptarse a cualquier tipo de puerta o ventana corredera sin dañarlas.
- La fijación con cinta adhesiva auto-adherente permite retirar la cuña y abrir en su totalidad puertas y ventanas.

FEATURES

- Restricts how wide sliding doors and windows can be opened.
- Its wedge shape means it will fit any type of sliding door or window without damaging it.
- As the block is stuck into place with self-adhesive tape, it can be removed to fully open doors and windows.

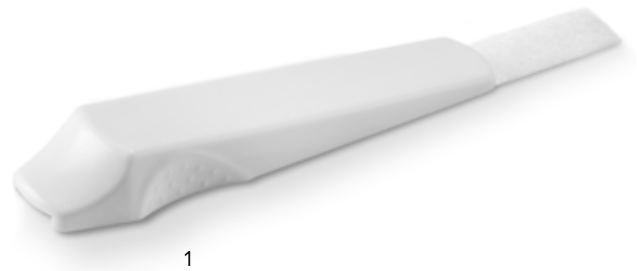



PROTECCIÓN EN BAÑERAS Y DUCHAS

PROTECTION IN BATHS AND SHOWERS

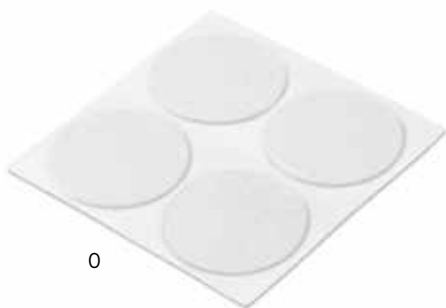

0

5301

Discos adhesivos anti-resbalones.
Adhesive non-slip pads.

Medidas producto
Product measures
1x38x38 mm

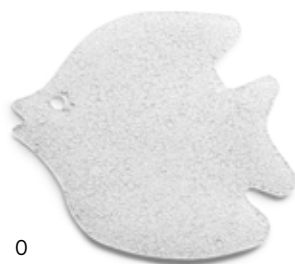
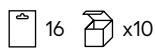

0

5302

Figuras adhesivas anti-resbalones. Pez.
Adhesive non-slip figures. Fish.

Medidas producto
Product measures
1x104x88 mm

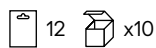

0

5304

Figuras adhesivas anti-resbalones. Pato.
Adhesive non-slip figures. Duck.

Medidas producto
Product measures
1x101x100 mm

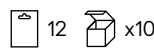

PROPIEDADES

- Material: PVC con adhesivo resistente al agua.
- Recomendado para el interior de duchas y bañeras.

FEATURES

- Material: PVC with waterproof adhesive.
- Recommended for showers and bathtubs.



3

5305

Termómetro infantil digital Cocodrilo.
Crocodile digital thermometer for bathtub.

Medidas producto
Product measures
42x106x77 mm

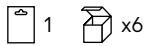

8

5306

Termómetro infantil digital Pato.
Duckling digital thermometer for bathtub.

Medidas producto
Product measures
62x97x67 mm

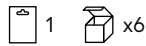

PROPIEDADES

- Termómetro con un divertido diseño para que los niños controlen la temperatura del agua de la bañera.
- Visualización de la temperatura en pantalla y luz LED de advertencia.
- Lecturas de temperatura precisas que se actualizan automáticamente cada 10 segundos.
- Doble función, el termómetro flota en la bañera y sirve de juguete apto para el baño de los niños.
- Incluye 2 pilas de botón LR44.
- Se apaga automáticamente tras 30 minutos de inactividad.
- Cumple normativas: marcaje producto CE, Directiva seguridad juguetes 2009/48/EC (TSD) ensayado según normas EN71 y EN62115, Directivas compatibilidad electromagnética 2014/30/EU (EMC) y baja tensión 2014/35/EU (LVD), Libre de Ftalatos y otros elementos químicos peligrosos según ROHS y REACH.

FEATURES

- Thermometer with a fun design for children to control bathtub water temperature.
- On-screen temperature display and LED warning light.
- Accurate temperature readings that automatically update every 10 seconds.
- Dual function, the thermometer floats in the bathtub and doubles as a bath-approved toy for children.
- Includes 2 LR44 button cells.
- Automatically turns off after 30 minutes of inactivity.
- Complies with regulations: CE product marking, Toy Safety Directive 2009/48/EC (TSD) tested according to EN71 and EN62115, Electromagnetic Compatibility Directive 2014/30/EU (EMC) and Low Voltage Directive 2014/35/EU (LVD), Free of phthalates and other hazardous chemicals according to ROHS and REACH.



2

5307

Cesta malla con ventosa 43x53 cm.
Mesh bag with suction cup 43 x 53 cm.

Medidas producto
Product measures
640x430x38 mm

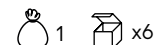



ELECTRICIDAD

ELECTRICITY



2

5400

Protector giratorio adhesivo para enchufe.
Adhesive swivel socket cover.

Medidas producto
Product measures
36x33x4 mm



ENCHUFES TIPO C
PLUGS TYPE C

PROPIEDADES

- Impide que el niño introduzca objetos o sus mismos dedos en el enchufe.
- Permite la utilización del enchufe con normalidad.

FEATURES

- Prevents children from inserting their fingers or other objects into plug sockets.
- Sockets can be used as normal.

ENCHUFES TIPO A
PLUGS TYPE A

PROPIEDADES

- Impide que el niño introduzca objetos o sus mismos dedos en el enchufe.
- Incluye una pequeña llave que facilita la extracción del protector del enchufe.
- Especial para enchufes de países de Centro y Sur América.

FEATURES

- This guard prevents the child from inserting objects or their fingers into the plug socket.
- The guard comes with a small key that facilitates the removal of the plug guard.
- This guard is specially designed for plugs sockets in Central and South American countries.



2

5402

Protector a presión para enchufe.
Snap-on plug socket guard.

Medidas producto
Product measures
23x36x22 mm



2

5407

Protector a presión para enchufe.
Snap-on plug socket guard.

Medidas producto
Product measures
45x45x27 mm



ENCHUFES TIPO G
PLUGS TYPE G

PROPIEDADES

- Impide que el niño introduzca objetos o sus mismos dedos en el enchufe.
- Incluye una pequeña llave que facilita la extracción del protector del enchufe.
- Especial para enchufes tipo G, presente en países como Malta y Chipre.

FEATURES

- This guard prevents the child from inserting objects or their fingers into the plug socket.
- The guard comes with a small key that facilitates the removal of the plug guard.
- It is also specially designed for G-type plug sockets, which are used in countries such as Malta and Cyprus.



2

ENCHUFES TIPO C
PLUGS TYPE C

5401

Protector a presión para enchufe.
Snap-on plug socket guard.

Medidas producto
Product measures
14x33x21 mm

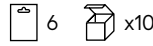

PROPIEDADES

- Impide que el niño introduzca objetos o sus mismos dedos en el enchufe.
- Incluye una pequeña llave que facilita la extracción del protector del enchufe.

FEATURES

- Prevents children from inserting their fingers or other objects into plug sockets.
- The guard comes with a small key that facilitates the removal of the plug guard.



COCHE Y PASEO

CAR & WALKING



5502

Ganchos giratorios para cochecito de bebé.
Swivel hooks for baby stroller.

Medidas producto
Product measures
146x44x51 mm

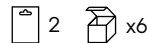

PROPIEDADES

- Ganchos giratorios multiusos ideales para instalar en el carrito para poder llevar el bolso, bolsas de compra o cualquier otra bolsa de mano.
- Muy fáciles de instalar y de retirar.
- Se instalan en el tubo de los mangos del cochecito mediante tiras de velcro ajustables.
- Carga máxima por gancho de 5,0kg.

FEATURES

- Universal multi-purpose swivel hooks to carry handbags or shopping bags in the stroller.
- Very easy to install and remove.
- They are installed by means of adjustable straps.
- Maximum load per hook 5.0 kg.



PROPIEDADES

- Mosquetón multiuso que facilita el ir cargado con bolsas de mano o de la compra.
- Incorpora una banda acolchada que lo hace más suave al tacto, evita daños en el mango del cochecito y ayuda a cargar mejor el peso.
- Apto para todos los tipos de coche de bebé.
- Ligero y fácil de quitar/poner en el cochecito (tanto lleno como vacío).
- Fabricado en aluminio, lo que le otorga propiedades muy resistentes y duraderas.
- Carga máxima de hasta 45kg.

FEATURES

- Makes carrying handbags or shopping bags easier.
- Includes a wrap that cushions, preventing damage to the stroller handle and helping to better distribute weight.
- Made of aluminium, which makes it very resistant and durable.
- Maximum load 45 kg.

5503

Mosquetón multiuso para cochecito de bebé.
Universal multi-purpose carabiner for baby stroller.

Medidas producto
Product measures
142x22x81 mm

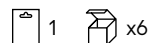

PROTECTORES PARA PARKING

PARKING LOT CAR
PROTECTION

Protectores parking
Parking protection

151



Protectores adhesivos para plazas parking

Adhesive protectors for parking lot



1

4102

Protector parking para columna.

Parking protector for column.

Medidas producto
Product measures
400x308x10 mm.

 1  x62





1

4101

Protector parking para cantos.

Parking protector for edges.

Medidas producto
Product measures
490x150x15 mm.

 1  x60





1

4103

Protector parking frontal.

Frontal parking protector.

Medidas producto
Product measures
195x330x40 mm.

 1  x30



1

4104

Protector parking lateral.

Lateral parking protector.

Medidas producto
Product measures
75x490x15 mm.

 1  x50





1

4105

Protector parking en rollo 2m.

Parking protect 2m. roll.

Medidas producto
Product measures
200x2000x5 mm.

 1  x30

COMPLEMENTOS PARA EL HOGAR

HOME
COMPLEMENTS

Rejillas de ventilación
Air grilles

153

Complementos varios
Other complements

161

Filtros de agua
Bathroom

165

Fundas para tablas de planchar
Ironing boards covers

168



GROSOR
THICKNESS
0,8 mm

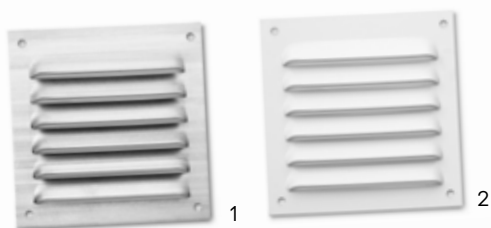

100x100 mm

1250

Rejilla de aluminio.
Sección de ventilación 25cm².
Fijación con tornillos
(no incluidos).
Aluminium air grille.
Ventilation section 25cm².
Screw-fastening
(screws not included).

Und.  x10



1273

Rejilla de aluminio.
CON MOSQUITERA.
Fijación con tornillos
(no incluidos).
Aluminium air grille.
WITH FLY SCREEN.
Screw-fastening
(screws not included).

Und.  x10

100x200 mm



1251

Rejilla de aluminio.
Sección de ventilación
50cm².
Fijación con tornillos
(no incluidos).
Aluminium air grille.
Ventilation section 50cm².
Screw-fastening
(screws not included).

Und.  x10



1274

Rejilla de aluminio.
CON MOSQUITERA.
Fijación con tornillos (no incluidos).
Aluminium air grille.
WITH FLY SCREEN.
Screw-fastening
(screws not included).

Und.  x10

100x300 mm



1264

Rejilla de aluminio.
Sección de ventilación 80cm².
Fijación con tornillos (no incluidos).
Aluminium air grille.
Ventilation section 80cm².
Screw-fastening
(screws not included).

Und.  x10

GROSOR
THICKNESS
0,8 mm

150x150 mm



1253

Rejilla de aluminio.
Sección de ventilación
75cm².
Fijación con tornillos
(no incluidos).
Aluminium air grille.
Ventilation section 75cm².
Screw-fastening (screws
not included).

Und. x10

1275

Rejilla de aluminio.
CON MOSQUITERA.
Fijación con tornillos
(no incluidos).
Aluminium air grille.
WITH FLY SCREEN.
Screw-fastening
(screws not included).

Und. x10



150x300 mm



1254

Rejilla de aluminio.
Sección de ventilación
150cm².
Fijación con tornillos
(no incluidos).
Aluminium air grille.
Ventilation section 150cm².
Screw-fastening (screws
not included).

Und. x10

1277

Rejilla de aluminio
CON MOSQUITERA.
Fijación con tornillos
(no incluidos).
Aluminium air grille
WITH FLY SCREEN.
Screw-fastening
(screws not included).

Und. x10



GROSOR
THICKNESS
0,8 mm

170x170 mm

1255

Rejilla de aluminio.
Sección de ventilación
150cm².
Fijación con tornillos
(no incluidos).
Aluminium air grille.
Ventilation section 150cm².
Screw-fastening (screws
not included).

Und.  x10

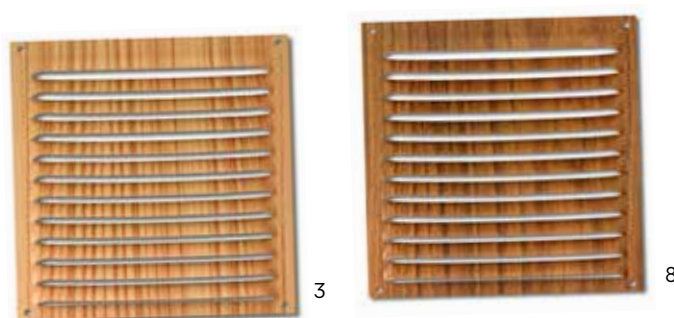
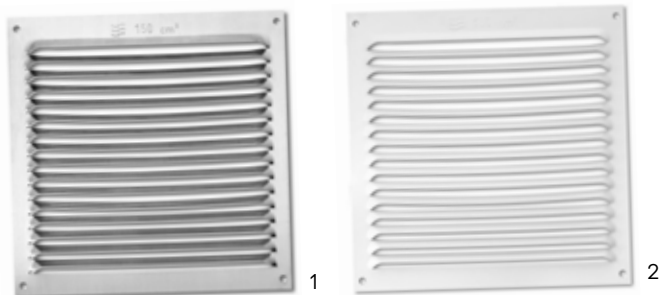

1278

Rejilla de aluminio.
CON MOSQUITERA.
Fijación con tornillos
(no incluidos).
Aluminium air grille.
WITH FLY SCREEN.
Screw-fastening
(screws not included).

Und.  x10

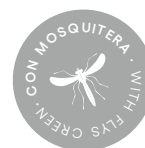

200x200 mm

1252

Rejilla de aluminio.
Sección de ventilación
125cm².
Fijación con tornillos
(no incluidos).
Aluminium air grille.
Ventilation section 125cm².
Screw-fastening (screws
not included).

Und.  x10

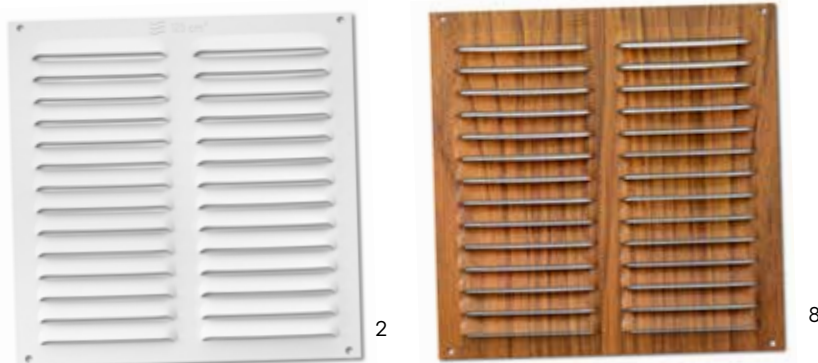
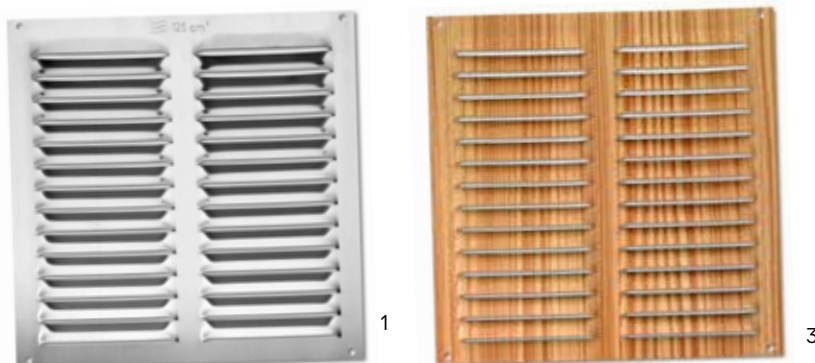

1276

Rejilla de aluminio.
CON MOSQUITERA.
Fijación con tornillos
(no incluidos).
Aluminium air grille.
WITH FLY SCREEN.
Screw-fastening
(screws not included).

Und.  x10



GROSOR
THICKNESS
0,8 mm

200x400 mm



1256

Rejilla de aluminio.
Sección de ventilación
175cm².
Fijación con tornillos
(no incluidos).
Aluminium air grille.
Ventilation section 175cm².
Screw-fastening (screws
not included).

Und.  x10



1279

Rejilla de aluminio.
CON MOSQUITERA.
Fijación con tornillos
(no incluidos).
Aluminium air grille.
WITH FLY SCREEN.
Screw-fastening
(screws not included).

Und.  x10



300x300 mm

GROSOR
THICKNESS
0,8 mm

1257

Rejilla de aluminio.
Sección de ventilación
300cm².
Fijación con tornillos
(no incluidos).
Aluminium air grille.
Ventilation section
300cm².
Screw-fastening (screws
not included).

Und.  x10



1

1280

Rejilla de aluminio
CON MOSQUITERA.
Fijación con tornillos
(no incluidos).
Aluminium air grille
WITH FLY SCREEN.
Screw-fastening
(screws not included).

Und.  x10



2



5



3



8

GROSOR
THICKNESS
0,8 mm

150x150 mm



1270

Rejilla de aluminio adhesiva.
Sección de ventilación 75cm².
Fijación opcional con tornillos (no incluidos).
Adhesive aluminium air grille.
Ventilation section 75cm².
Optional screw-fastening (screws not included).

Und.  x10

170x170 mm

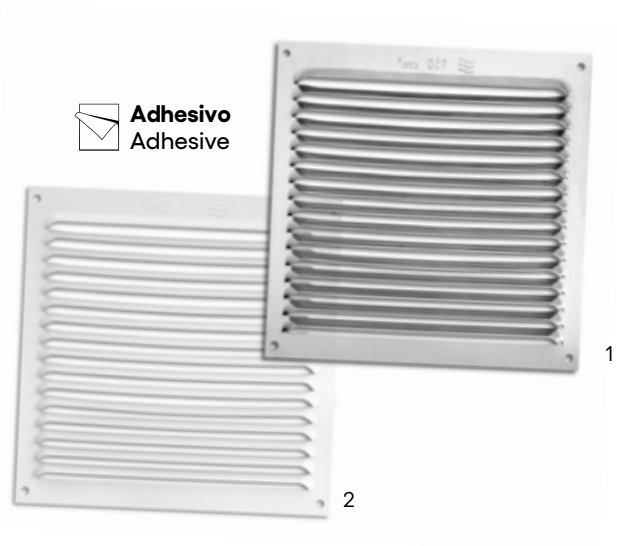

1271

Rejilla de aluminio adhesiva.
Sección de ventilación 150cm².
Fijación opcional con tornillos (no incluidos).
Adhesive aluminium air grille.
Ventilation section 150cm².
Optional screw-fastening (screws not included).

Und.  x10



1272

Rejilla de aluminio adhesiva.
Sección de ventilación 125cm².
Fijación opcional con tornillos (no incluidos).
Adhesive aluminium air grille.
Ventilation section 125cm².
Optional screw-fastening (screws not included).

Und.  x10

200x200 mm

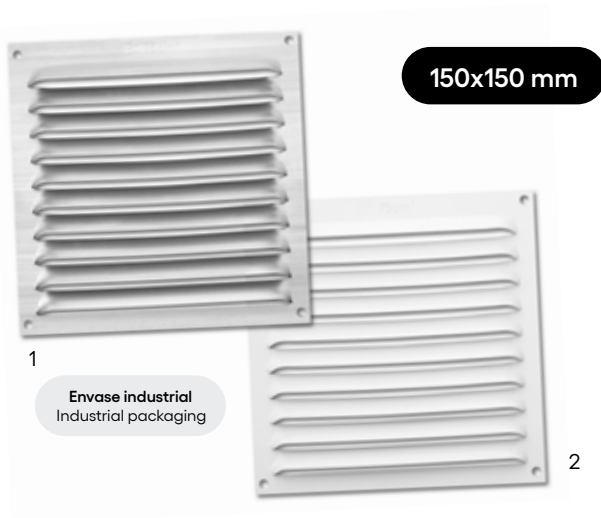

150x150 mm

1

Envase industrial
Industrial packaging

2

1265

Rejilla de aluminio.
Sección de ventilación 75cm².
Fijación con tornillos (no incluidos).
Aluminium air grille.
Screw-fastening (screws
not included).

Und.  x100

Grosor 0,6 mm.
Thickness 0,6 mm.



170x170 mm

2

1

1261

Rejilla de aluminio con persiana
y mecanismo de cierre para
poder graduar la aireación.
Sección de ventilación ~80cm².
Fijación con tornillos (no incluidos).
Aluminium air grille with blind
and closing mechanism for
adjusting ventilation.
Ventilation section ~80cm².
Screw-fastening (screws
not included).

Grosor 0,8 mm.
Thickness 0,8 mm.

Und.  x10





Ø 100-130 mm

2

1267

Rejilla redonda con
mosquitera para tubos
Ø100-130mm.

Round air vent grille
for tubes Ø100-130
mm. with fly screen.

 1  x10





150x150 mm



1259

Rejilla de aluminio con marco.
Sección de ventilación 35cm².
Fijación con tornillos (no incluidos).
Aluminium air grille with frame.
Ventilation section 35cm².
Screw-fastening (screws
not included).

Grosor 0,8 mm.
Thickness 0,8 mm.

Und.  x10

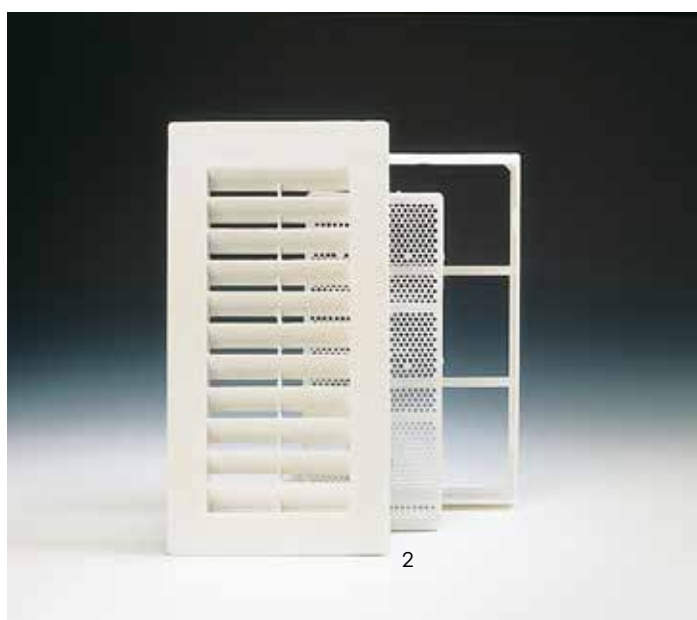

260x132 mm



1262

Rejilla de ventilación para
conductos shunt.
Sección de ventilación 45cm²
(sin mosquitera 105cm²).
Shunt air grille.
Ventilation section 45cm².
(without fly screen 105cm²).

Medidas producto
Product measures
260x132 mm.

Und.  x10

1191

Arandela para llaves.
Key ring.

Medidas producto
Product measures
Ø22 x 4,5 mm.

5  x20

Und.  x50

Und.  x100



0



1192*

Llavero porta-etiquetas.
Key label holders.

Medidas producto
Product measures
22x56x3 mm.

7  x20

Und.  x25

Und.  x70

* Envase surtido para este producto.
Assorted pack available for this product.



1190

Pinza sujeta-mantel.
Table cloth nippers.

Medidas producto
Product measures
33x50x14 mm.

4  x10

Und.  x50



2

1193*

Llavero porta-etiquetas.
Key label holders.

Medidas producto
Product measures
37 x 58 x 3 mm.

Und.  x25

Und.  x70

* Envase surtido para este producto.
Assorted pack available for this product.



1



1194

Pinza sujeta-mantel.
Table cloth nippers.

Medidas producto
Product measures
41x14x55mm.

4  x10

Und.  x50



Complementos cocina.

Kitchen
complements.



Topos
Polka dots



Hojas
Leaves

1141

Agarradores para la cocina
20x20cm con acolchado
100% algodón y polyester.
20x20 cm padded kitchen
potholder, 100% cotton
and polyester.

Medidas producto
Product measures
200x200x5 mm.



COMPOSICIÓN:

- Tejido 100% algodón estampado.
- Incluye acolchado de algodón y polyester.
- Material auto extingüible.
- Set de 2 unidades.

COMPOSITION:

- 100% printed cotton.
- Cotton and polyester padding included.
- Self-extinguishing material.
- Two units set.



Topos
Polka dots



Hojas
Leaves

1148

Guantes de horno para la
cocina 30x18cm con acolchado
100% algodón y polyester.
30x18 cm padded kitchen oven
mitts, 100% cotton and polyester.

Medidas producto
Product measures
300x180x15 mm.



COMPOSICIÓN:

- Tejido 100% algodón estampado.
- Incluye acolchado de algodón y polyester.
- Material auto extingüible.
- Forro interior de TST (técnico sin tejer).
- Set de 2 unidades.

COMPOSITION:

- 100% printed cotton.
- Cotton and polyester padding included.
- Self-extinguishing material.
- Nonwoven fabric inner lining.
- Two units set.



2

2030

Abrebotellas adhesivo.
Fijación opcional con
tornillos (no incluidos).
Key ring. Adhesive
bottle opener.
Optional screw-fastening
(screws not included).

Medidas producto
Product measures
58 x 61 x 33 mm.

1 x6

3011

Patín bombona butano.
Butane skid.

Medidas producto
Product measures
68 x Ø310 mm.

1 x10



4



1

3107

Cuchillas
para rascador.
Scraper blades.

Medidas producto
Product measures
22 x 43 x 0,15mm.

5 x30



7

3106

Rascador.
Scraper.

Medidas producto
Product measures
109 x 49 x 13 mm.

1 x40

Protección anti-vibración y desplazamientos.

Anti-vibration and anti-walk pads.



3104

Almohadilla anti-vibración.
Anti-vibration pads.

Medidas producto
Product measures
10x75x75 mm.

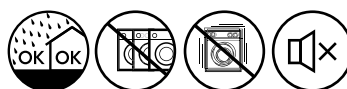
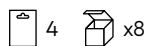

Ayuda a mantener las tuberías limpias.

Help for keeping pipes clear and clean.



3015

Filtro de acero inoxidable para sumidero. Adecuado para sumideros de Ø42-62mm.
Stainless steel drain filter. Suitable to Ø42-62mm drains.

Medidas producto
Product measures
5 x Ø65 mm.



3016

Filtro de acero inoxidable para sumidero. Adecuado para sumideros de Ø52-72mm.
Stainless steel drain filter. Suitable to Ø52-72mm drains.

Medidas producto
Product measures
5 x Ø80 mm.



Aireadores con dos posiciones.

Aerators with two positions.

**AHORRA
SAVES**

40%



1320

Aireador con rótula direccional y dos posiciones. Fijación con abrazadera 100% adaptable.
Swivel tap aerators with two positions. Fully adaptable clamp fitting.

Medidas producto
Product measures
86x38x36 mm.

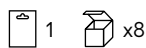

1321

Aireador con rótula direccional y dos posiciones. Fijación con rosca H22 y adaptador M24.
Swivel tap aerator with two positions. Fitted using an H22 thread and M24 adaptor.

Medidas producto
Product measures
58x36x36 mm.

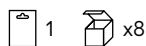

1322

Aireador con tubo flexible y dos posiciones. Fijación con abrazadera 100% adaptable.
Aerator with flexible hose and two positions. Fully adaptable clamp fitting.

Medidas producto
Product measures
158x36x36 mm.

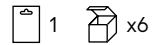

1323

Aireador con tubo flexible metálico y dos posiciones. Fijación con rosca H22 y adaptador M24.
Aerator with flexible metal hose and two positions. Fitted using an H22 thread and M24 adaptor.

Medidas producto
Product measures
141x36x36 mm.

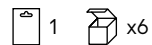

1324

Aireador con tubo flexible y dos posiciones. Fijación con rosca H22 y adaptador M24.
Aerator with flexible hose and two positions. Fitted using an H22 thread and M24 adaptor.

Medidas producto
Product measures
155x36x36 mm.

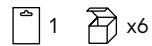

* Ahorro del 30-40% según modelo. Presión 3-5 Bar.
Ensayos realizados por Applus.

* Save 30-40% according to model. Pressure 3-5 bar.
Tests conducted by Applus.



**AHORRA
SAVES**

70%



1325
Aireador de latón.
Fijación con rosca H22.
Brass aerator.
H22 thread fitting.

Medidas producto
Product measures
17x23x23 mm

1 x10



1326
Aireador de latón.
Fijación con rosca M24.
Brass aerator.
M24 thread fitting.

Medidas producto
Product measures
13x23x23 mm

1 x10



1327
Aireador de latón con
rótula direccional.
Fijación con rosca M24.
Brass swivel aerator.
Fitted using an
M24 adaptor.

Medidas producto
Product measures
34x25x25 mm

1 x10



1310
Recambio para
depurador de agua.
Water filter
replacement.

Medidas producto
Product measures
4,7 cm

1 x10



1328
Aireador de latón con
rótula direccional.
Fijación con rosca H22.
Brass swivel aerator.
Fitted using an
H22 thread.

Medidas producto
Product measures
36x23x23 mm

1 x10



1308
Depurador de agua.
Water filter.

Medidas producto
Product measures
13,3 cm

1 x6

* Ahorro del 70%. Presión 3-5 Bar.
Ensayos realizados por Applus.

* Save up to 70%. Pressure 3-5 bar.
Tests conducted by Applus.

Fundas para tablas de planchar.

Ironing
board covers.

COMPLEMENTOS PARA EL HOGAR - FUNDAS PARA TABLAS DE PLANCHAR
HOME COMPLEMENTS - IRONING BOARDS COVERS

168

COTTON

1340

Funda COTTON para tabla de planchar.
100% Algodón con muletón.
COTTON cover for ironing board.
100% cotton with felt backing.

Medidas producto
Product measures
130x48cm.



100% ALGODÓN
100% COTTON



INCLUYE CLIP DE FIJACIÓN
FASTENING CLIP INCLUDED



Topos
Polka dots



Círculos
Circles



Mandala
Mandala

CAPAS
LAYERS

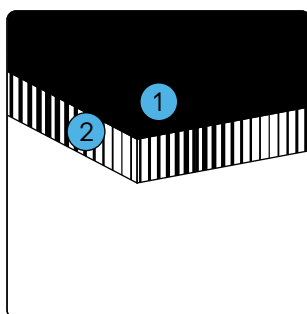

COMPOSICIÓN:

- 1 Tejido 100% algodón de 90gr/m² estampado con colores sólidos.
 - 2 Muletón de polyester y fibras mixtas de 200gr/m².
- Sistema de fijación con cordoncillos y clip de fijación.

COMPOSITION:

- 1 90gr/m² 100% cotton, printed with solid colours.
 - 2 200gr/m² felt backing in polyester and mixed fibres.
- Adjustable drawcord with clip for a tight fit.

METAL

1341

Funda METAL para tabla de planchar. 100% Algodón metalizado con muletón. METAL cover for ironing board. 100% metallised cotton with felt backing.

Medidas producto
Product measures
130x48cm.



100% ALGODÓN
METALIZADO
100% METALLIZED
COTTON



INCLUYE CLIP
DE FIJACIÓN
FASTENING
CLIP INCLUDED



Metalizado
Metallic

CAPAS
LAYERS

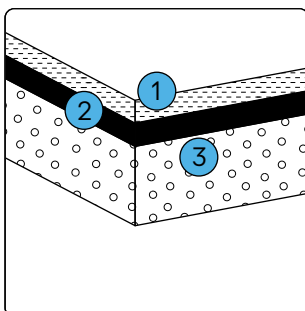

COMPOSICIÓN:

- 1 Acabado de aluminio (sin amianto) para distribuir mejor el calor.
 - 2 Tejido 100% algodón de 90gr/m2.
 - 3 Muletón de polyester y fibras mixtas de 200gr/m2.
- Sistema de fijación con cordoncillos y clip de fijación.

COMPOSITION:

- 1 Aluminium finish (asbestos-free) for an improved heat distribution.
 - 2 90gr/m2 100% cotton.
 - 3 200gr/m2 felt backing in polyester and mixed fibres.
- Adjustable drawcord with clip for a tight fit.

COTTON PLUS

1343

Funda COTTON PLUS para tabla de planchar.
100% Algodón con espuma y muletón.
COTTON PLUS cover for ironing board.
100% cotton, padded, with felt backing.

Medidas producto
Product measures
130x48cm.



100% ALGODÓN
100% COTTON



INCLUYE CLIP DE FIJACIÓN
FASTENING CLIP INCLUDED



Rayas
Stripes



Círculos
Circles



Siluetas
Silhouettes

CAPAS
LAYERS

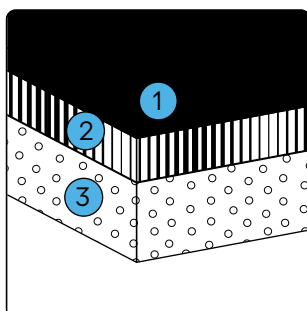

COMPOSICIÓN:

- 1 Tejido 100% algodón de 115gr/m2 estampado con colores sólidos.
 - 2 Capa de espuma de 2mm de grosor.
 - 3 Muletón espeso 100% polyester.
- Sistema de fijación con cordoncillos y clip de fijación.

COMPOSITION:

- 1 115gr/m2 100% cotton, printed with solid colours.
 - 2 2mm thick foam layer.
 - 3 Thick 100% polyester felt backing.
- Adjustable drawcord with clip for a tight fit.

METAL PLUS

1345

Funda METAL PLUS para tabla de planchar. 100% Algodón metalizado con espuma y muletón.
METAL PLUS cover for ironing board. 100% metallised cotton, padded, with felt backing.

Medidas producto
Product measures
130x48cm.



100% ALGODÓN
100% COTTON



PLANCHADO FÁCIL
EASY IRONING



INCLUYE CLIP DE FIJACIÓN
FASTENING CLIP INCLUDED



Pictos verdes
Green drawings



Pictos azules
Blue drawings



Aves
Birds

CAPAS
LAYERS

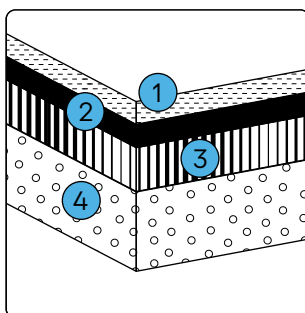

COMPOSICIÓN:

- 1 Acabado de aluminio (sin amianto) para distribuir mejor el calor.
 - Perforaciones termo reflejantes especiales para el planchado a vapor (con una pasada plancha las dos caras).
- 2 Tejido 100% algodón estampado con colores sólidos.
- 3 Capa de espuma de 2mm de grosor.
- 4 Muletón espeso 100% polyester.
 - Sistema de fijación con cordoncillos y clip de fijación.

COMPOSITION:

- 1 Aluminium finish (asbestos free) for an improved heat distribution.
 - Special heat-reflecting holes for steam ironing . (can iron both sides on a single pass).
- 2 100% cotton, printed with solid colours.
- 3 2mm thick foam layer.
- 4 Thick 100% polyester felt backing.
 - Adjustable drawcord with clip for a tight fit.

ELASTIC FIT

1342

Funda universal
ELASTIC FIT
para tabla de planchar.
100% Algodón elástico
con muletón.
ELASTIC FIT universal
cover for ironing board.
100% flexible cotton
with felt backing.

Medidas producto
Product measures
135x50cm.



100% ALGODÓN
ELÁSTICO
100% ELASTIC
COTTON



ELÁSTICA
UNIVERSAL
UNIVERSAL
ELASTIC



Hojas
Leaves



Topos
Polka dots



Flores
Flowers

CAPAS
LAYERS

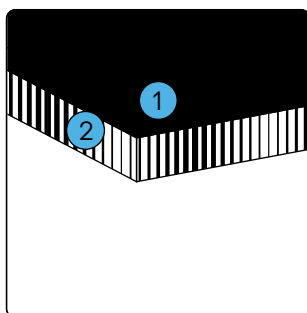

COMPOSICIÓN:

- 1 Tejido 100% algodón extensible estampado con colores sólidos.
 - 2 Muletón espeso 100% polyester.
- Adaptación perfecta y rápida gracias a la goma elástica en los bordes.
 - Universal, se adapta a todas las tablas de planchar hasta un máximo de 130x45cm.

COMPOSITION:

- 1 100% elasticated cotton fabric.
 - 2 Thick 100% polyester backing.
- Perfect and quick fit thanks to the rubber band on the edges.
 - Universal, fits any ironing board of up to 130x45 cm.

TITANIUM

1346

Fundas TITANIUM para tabla de planchar. 100% Algodón metalizado con espuma y muletón.
TITANIUM cover for ironing board. 100% metallised cotton, padded, with felt backing.

Medidas producto
Product measures
130x48cm.



100% ALGODÓN
TITANIZADO
100% TITANIZED
COTTON



RESISTENTE AL
CALOR
HEAT RESISTANT



INCLUYE CLIP
DE FIJACIÓN
FASTENING
CLIP INCLUDED



Hojas
Leaves



Siluetas
Silhouettes



Flores cerezo
Cherry tree flowers

CAPAS
LAYERS

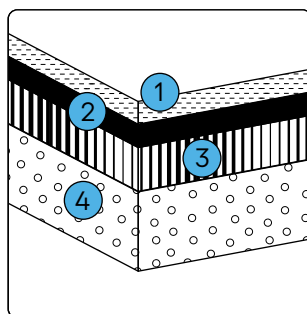

COMPOSICIÓN:

- 1 Acabado de titanio y resinas acrílicas. Resistente al calor.
- Perforaciones termo reflejantes especiales para el planchado a vapor (con una pasada plancha las dos caras).
- 2 Capa de tejido 100% algodón estampado de 145gr/m2.
- 3 Capa de espuma de 2mm de grosor.
- 4 Espeso muletón de 100% polyester.
- Sistema de fijación con cordoncillos y clip de fijación.

COMPOSITION:

- 1 Titanium and acrylic resins finish. Heat-resistant.
- Special heat-reflecting holes for steam ironing (can iron both sides on a single pass).
- 2 145 gr/m2 100% printed cotton layer.
- 3 2mm thick foam layer.
- 4 100% thick polyester felt backing.
- Adjustable drawcord with clip for a tight fit.

POWER VAP

1347

Funda POWER VAP para tabla de planchar. Especial para centros de planchado a vapor. 100% Algodón con lámina de aluminio, espuma+muletón. POWER VAP cover for ironing board. Perfect for steam stations. 100% cotton with aluminium layer, padded, with felt backing.

Medidas producto
Product measures
130x480 cm.

👜 1 📦 x25

 DOBLA LA FUERZA DEL VAPOR
DOUBLES THE STRENGTH OF STEAM

 FUNCIÓN ANTI-GOTEO
ANTI DRIP FUNCTION

 INCLUYE CLIP DE FIJACIÓN
FASTENING CLIP INCLUDED

Letras
Letters



Rayas
Stripes



Topos
Polka dots



Flores
Flowers

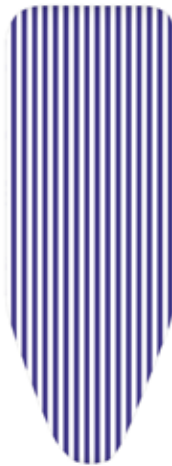

Rayas
Stripes



Topos
Polka dots



Flores
Flowers

XL

1347L

Funda POWER VAP para tabla de planchar. Especial para centros de planchado a vapor. 100% Algodón con lámina de aluminio, espuma+muletón. POWER VAP cover for ironing board. Perfect for steam stations. 100% cotton with aluminium layer, padded, with felt backing.

Medidas producto
Product measures
140x55 cm.

👜 1 📦 x20

CAPAS
LAYERS

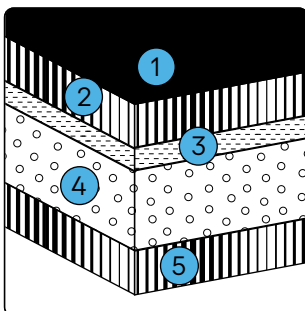

COMPOSICIÓN:

- 1 Tejido 100% algodón estampado con colores sólidos.
 - 2 Capa de espuma de 2mm de grosor.
 - 3 Lámina de aluminio para retener y distribuir mejor el calor. Actúa de capa protectora para que no traspase el agua.
 - 4 Muletón espeso 100% polyester.
 - 5 Segunda capa de espuma de 2mm de grosor.
- Sistema de fijación con cordoncillos y clip de fijación.

COMPOSITION:

- 1 100% cotton, printed with solid colours.
 - 2 2mm thick foam layer.
 - 3 Aluminium layer for an improved heat retention and distribution. Acts as a protective layer to prevent water from dripping.
 - 4 Thick 100% polyester felt backing.
 - 5 SSecond 2mm thick foam layer.
- Adjustable drawcord with clip for a tight fit.

PARKING PROTEK

1344

Funda PARKING PROTEK para tabla de planchar.
100% Algodón con espuma y muletón.
PARKING PROTEK cover for ironing board.
100% cotton, padded, with felt backing.

Medidas producto
Product measures
130x48cm.

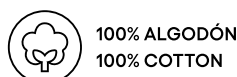

● Zona especial PARKING PROTEK de tejido ignífugo.
Special PARKING PROTEK area made of fireproof fabric.



Peces
Fish



Círculos
Circles



Hojas
Leaves

CAPAS
LAYERS

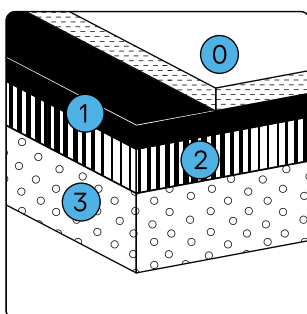

COMPOSICIÓN:

- 0 Zona especial PARKING PROTEK de tejido ignífugo.
 - 1 Tejido 100% algodón de 140gr/m2.
 - 2 Capa de espuma de 2mm de grosor.
 - 3 Muletón espeso 100% polyester.
- Sistema de fijación con cordoncillos y clip de fijación.

COMPOSITION:

- 0 Special PARKING PROTEK area made of fireproof fabric.
 - 1 140 g/m2 of 100% cotton fabric.
 - 2 2-mm-thick foam layer.
 - 3 Thick 100% polyester felt.
- Adjustable drawcord with clip for a tight fit.

E-COVER

1348

Funda E-COVER para tabla de planchar. 100% Algodón con muletón.
E-COVER cover for ironing board. 100% cotton with felt backing.

Medidas producto
Product measures
130x48cm.



100% ALGODÓN
ORGÁNICO
100% ORGANIC
COTTON



100% LANA NATURAL
100% NATURAL WOOL



TEJIDO NATURAL
SIN QUÍMICOS
NATURAL FABRIC
NO CHEMICALS



Beige
Beige

CAPAS
LAYERS

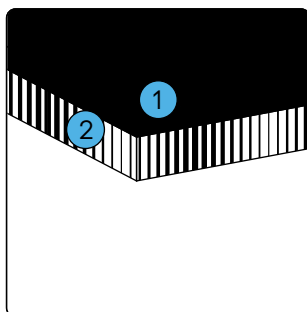

COMPOSICIÓN:

- 1 Tejido 100% algodón natural sin tratamientos químicos.
 - 2 Muletón lana natural.
- Sistema de fijación con cordoncillos.

COMPOSITION:

- 1 100% natural cotton fabric free of chemicals.
 - 2 Natural wool felt.
- Drawstring fastening system.

SOPORTE AL PUNTO DE VENTA

POINT OF SALE ASSISTANCE

Servicio de atención al cliente
Customer service

179

Trabajamos con usted
We work with you

180

Compra por impulso
Impulse buying

181

Expositores y material P.L.V.
Displays racks and P.O.S material

182

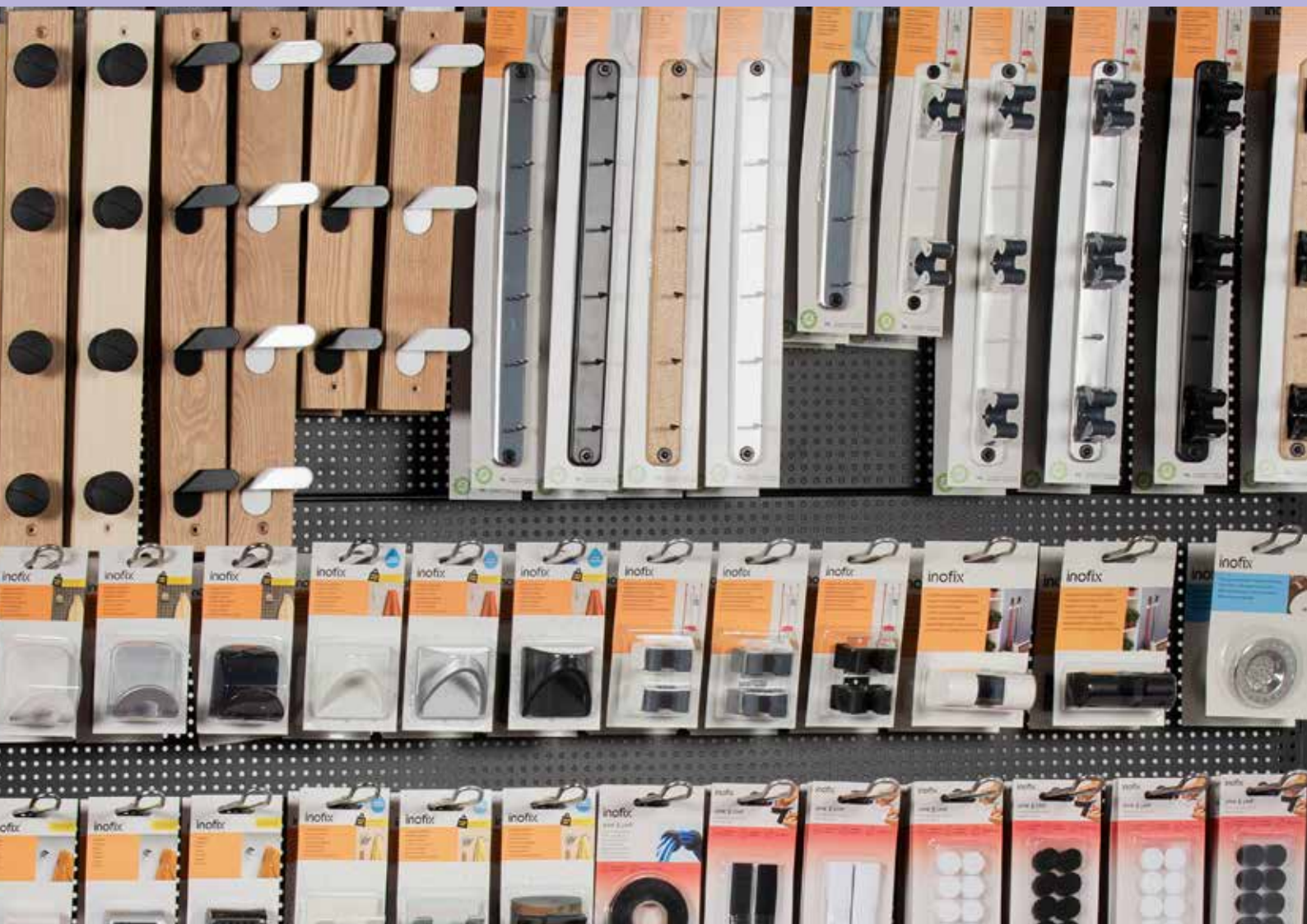



SERVICIO DE ATENCIÓN AL CLIENTE.

CUSTOMER
SERVICE.

Le facilitamos toda la información de los productos y le ayudamos a resolver sus dudas técnicas.

Realizamos el seguimiento de sus expediciones y gestionamos eficazmente las incidencias que pudieran surgir.

We provide you with full information about our products and help you resolving any technical doubt you may have.

We track all of your orders and give an immediate response to any incidents that may arise.

TRABAJAMOS CON USTED.

WE WORK WITH YOU.

Máxima rentabilidad en el punto de venta.

Maximum profitability at the point of sale.



ESTUDIO

A partir de nuestro conocimiento sobre el mercado, elaboramos informes y estadísticas para cada familia de productos.

STUDY

We draw up reports and statistics for each product family based on our knowledge of the market.

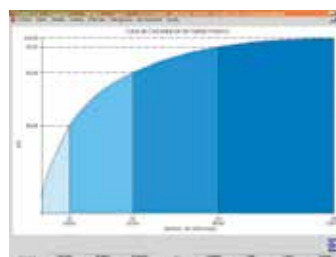

ANÁLISIS

Analizando las ventas de nuestros clientes podemos establecer que surtido de productos es el óptimo para cada punto de venta.

ANALYSIS

We analyse our customer sales in order to provide the most suitable selection of products for each point of sale.

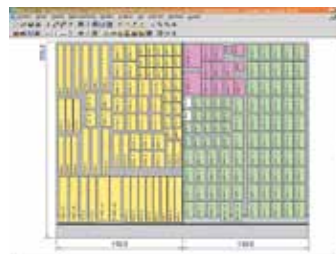

IMPLANTACIÓN

Proponemos la disposición espacial de las referencias para que se genere una mayor rotación en el punto de venta.

IMPLEMENTATION

We suggest how our best sellers should be arranged in each point of sale to ensure greater turnover.



COMPRA POR IMPULSO.

IMPULSE BUYING.

Para dinamizar el punto de venta disponemos de variadas soluciones para facilitar la exposición. Nuestras presentaciones impulsan la venta centrando la atención sobre el producto y destacando sus cualidades.

We can offer a variety of display options to boost sales in retail outlets. Our displays drive sales up by drawing attention to our products and highlighting their qualities.



RISTRAS

Colgar los blísters en ristras posibilita la venta cruzada.

STRIPS

Hanging blister strips stimulates sales.



BOLSAS

La presentación en bolsa permite ofrecer una mayor cantidad de producto a un menor coste para el consumidor.

BAGS

Bag presentation makes selling in bigger quantities possible, at a lower price for consumers.



EXPOSITORES SOBREMESA

Los distintos expositores facilitan la venta en mostradores o en las zonas bajas de los lineales.

COUNTER DISPLAY BOXES

To promote sales. Suitable for counters and for shelves in the stores.



EXPOSITORES Y MATERIAL P.L.V.

DISPLAY RACKS AND P.O.S MATERIAL.

Para facilitar la labor del punto de venta y maximizar la exposición de productos, colaboramos con displays y expositores pensados para múltiples espacios.

In order to make the work of points of sale easier and display as many products as possible, we have designed display racks to fit in different spaces.

EXPOSITORES MURALES

DISPLAY RACKS

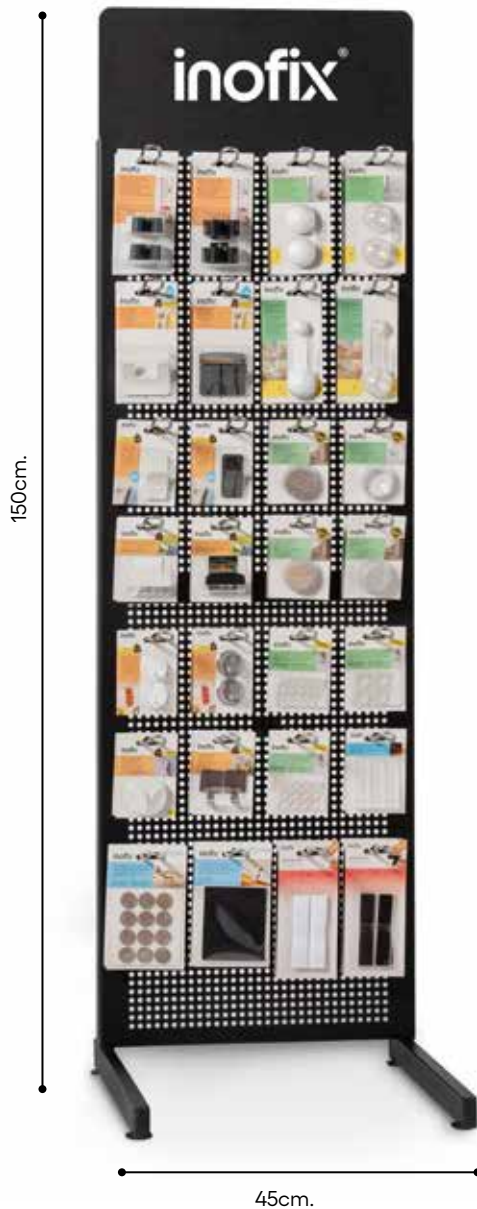

0008-1-

Mueble
expositor metálico.
Metal display rack.

Medidas expositor
Display rack measures
alto/high: 150cm.
ancho/width: 45cm.
fondo/depth: 50cm.

GANCHOS DE REPUESTO REPLACEMENT HOOKS



0001-2+

10 ganchos de
repuesto para expositor.
10 Display rack hooks.

Medidas ganchos:
Hooks measures:
Largo/Length: 20 cm.

Los expositores se sirven sin producto.
Display racks are delivered without products.

EXPOSITORES MURALES

DISPLAY RACKS



0001-1C

Mueble
expositor metálico.
Metal display rack.

Medidas expositor
Display rack measures
alto/high: 220cm.
ancho/width: 130cm.
fondo/depth: 50cm.

EXPOSITORES MURALES

DISPLAY RACKS

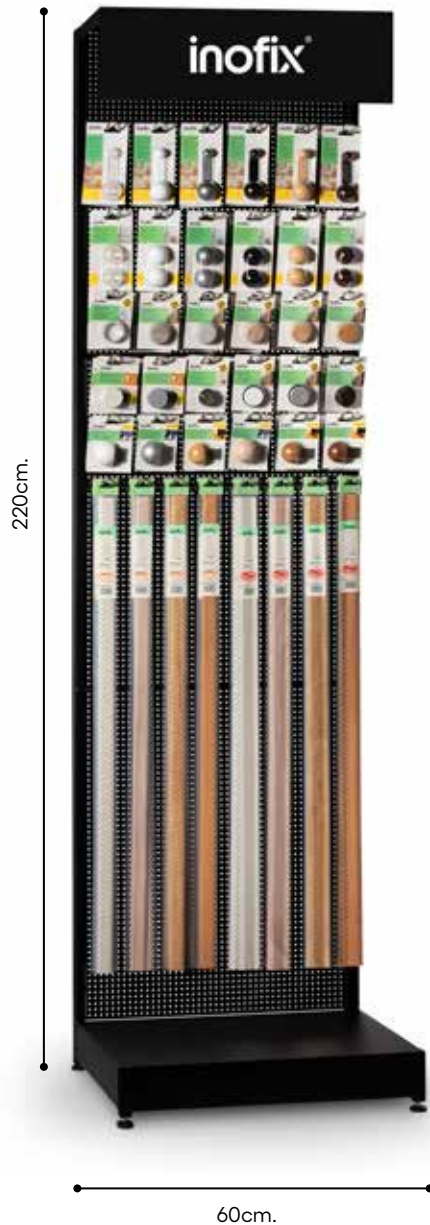

0001-5C

**Mueble
expositor metálico.**
Metal display rack.

Medidas expositor
Display rack measures
alto/high: 220cm.
ancho/width: 60cm.
fondo/depth: 50cm.

GANCHOS DE REPUESTO REPLACEMENT HOOKS



0001-3A

**10 ganchos etiqueteros
de repuesto para expositor.**
10 display rack hooks
with label holder.

Medidas ganchos:
Hooks measures:
Largo/Length: 30 cm.

Los expositores se sirven sin producto.
Display racks are delivered without products.

EXPOSITORES ESPECÍFICOS DE GAMA

DISPLAY RACKS FOR SPECIFIC RANGE OF PRODUCTS



0010-7+

Expositor
Canaleta eléctrica.
Cable duct display rack.

Medidas expositor
Display rack measures
alto/high: 223cm.
ancho/width: 90cm.
fondo/depth: 46cm.



0010-8+

Expositor
Canaleta eléctrica.
Cable duct display rack.

Medidas expositor
Display rack measures
alto/high: 223cm.
ancho/width: 45cm.
fondo/depth: 46cm.

Los expositores se sirven sin producto.
Display racks are delivered without products.

EXPOSITORES ESPECÍFICOS DE GAMA

DISPLAY RACKS FOR SPECIFIC RANGE OF PRODUCTS



0002-8A

Expositor Cablefix.
Cablefix display rack.

Medidas expositor
Display rack measures
alto/high: 178cm.
ancho/width: 54cm.
fondo/depth: 36cm.

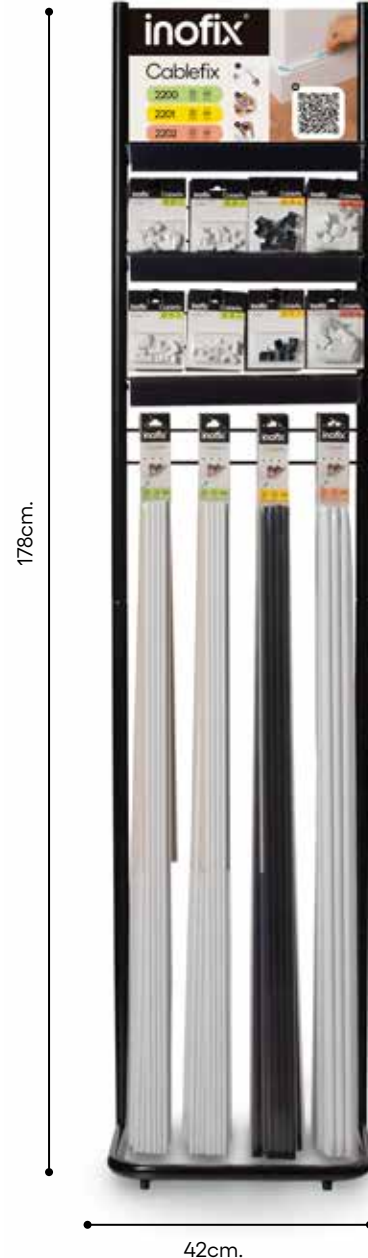

0002-4A

Expositor Cablefix.
Cablefix display rack.

Medidas expositor
Display rack measures
alto/high: 178cm.
ancho/width: 42cm.
fondo/depth: 36cm.

Los expositores se sirven sin producto.
Display racks are delivered without products.

EXPOSITORES ESPECÍFICOS DE GAMA

DISPLAY RACKS FOR SPECIFIC RANGE OF PRODUCTS



0003-1+

Expositor tapajuntas
con 20 ganchos.
Coverstrip display
rack with 20 hooks.

Medidas expositor
Display rack measures
alto/high: 160cm.
ancho/width: 60cm.
fondo/depth: 35cm.

EXPOSITORES ESPECÍFICOS DE GAMA

DISPLAY RACKS FOR SPECIFIC RANGE OF PRODUCTS



0005*

Expositor gama seguridad infantil.
Display rack for child safety items.

Medidas expositor
Display rack measures
alto/high: 150cm.
ancho/width: 79cm.
fondo/depth: 38cm.

* Expositor disponible en español, portugués e inglés.
Display rack available in Spanish, Portuguese and English.



0007-1-

Expositor gama gadgets ordenación de cables.
Display rack for cable management items.

Medidas expositor
Display rack measures
alto/high: 150cm.
ancho/width: 57cm.
fondo/depth: 38cm.

* Expositor disponible en español y portugués.
Display rack available in Spanish and Portuguese.

Los expositores se sirven sin producto.
Display racks are delivered without products.

MATERIAL SOPORTE P.L.V.

P.O.S SUPPORT MATERIAL

0002-2-

Display gama Cablefix
con peana.
Cablefix counter display.

Medidas
Measures
30x42 cm.



0010-6+

Display gama canaleta.
Cable duct display.

Medidas
Measures
36x36 cm.



0006-1-

Expositor sobremesa
ordenación de cables.
Tabletop display cable
management.

Medidas expositor
Display rack measures
alto/high: 50cm.
ancho/width: 35,5cm.
fondo/depth: 22cm.



Los expositores se sirven sin producto.
Display racks are delivered without products.

MATERIAL SOPORTE P.L.V.

P.O.S SUPPORT MATERIAL

0010-9-*

Display seguridad infantil.
Child safety display.

Medidas
Measures
55x30 cm.

* Display disponible en español.
Para otros idiomas
contacte con nosotros.
Display available in Spanish.
Contact us for other
languages availability.



0030-0-

Ristra Infix vacía
con capacidad para
10 blísters o bolsas.
Infix empty string
with capacity for 10
blisters or bags.

Medidas
Measures
65x6,3 cm.



0017-0-

Expositor PLV para blísters.
Empty display box.

Medidas
Measures
7x37,5x28,5 cm.



0012-0-

Demostrador mod. 2037.
Demonstrator mod. 2037.



Los expositores se sirven sin producto.
Display racks are delivered without products.



TABLA DE INFORMACIÓN DE ARTICULOS

ARTICLE INFORMATION TABLE

¿Cómo leer la tabla?
How to read the table?







194

La tabla
The table

195

¿CÓMO LEER LA TABLA?

HOW TO READ THE TABLE?

1	2	3	4	5	6
MODELO MODEL	COLOR COLOUR	ARTÍCULO ARTICLE	EAN ARTÍCULO EAN ARTICLE	EMBALAJE PACKING	EAN EMBALAJE EAN PACKING
1420		Contera redonda interior Ø 20 mm - Inner round ferrule Ø20 mm.			
	blanco - white	1420-2G 000		 x50	 8414419009608
	negro - black	1420-3- 000	8414419142039	 x20	 8414419802230
	negro - black	1420-3G 000		 x50	 8414419002890

1 Número de referencia del modelo y descripción.
Model reference number and description.

2 Colores o acabados.
Colours or finishes.

3 Referencia del artículo y número de código de color o acabado.
Article reference and colour or finish code.

4 Código de barras EAN13 del artículo.
EAN13 article bar code.

5 Embalaje.
Packing.

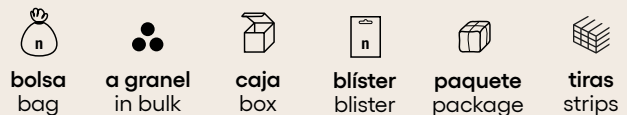

6 EAN13 embalaje...
EAN13 packing...

MEDIDAS PRODUCTOS / PRODUCT MEASURES













































Las medidas indicadas en todos los modelos se especifican según criterio (alto x ancho x fondo).
Standard measurements are given for all models (height x width x depth).

SAINT GENIS S.A.



































Se reserva el derecho a alterar las características de los productos incluidos en el presente catálogo, así como a incorporar o eliminar algunos productos de la colección.

Reserves the right to change the characteristics of the products included in this catalogue and to add or remove any products from the collection.

MODELO MODEL	COLOR COLOUR	ARTÍCULO ARTICLE	EAN ARTÍCULO EAN ARTICLE	EMBALAJE PACKING	EAN EMBALAJE EAN PACKING
1050		Pinza sujeta-zócalos para tubo de Ø 30-35 mm. - Socle clamp for tube Ø 30-35 mm.			
	negro - black	1050-3G	000	 x50	U. 8414419003842
1071		Pie nivelador Ø 30 (M10x33) - Levelling leg Ø30 mm. (M10 x 33 mm.)			
	negro - black	1071-3G	000	 x25	U. 8414419011397
1073		Pie nivelador Ø 30 (M8x40) - Levelling leg Ø30 mm. (M8 x 40 mm.)			
	negro - black	1073-3G	000	 x25	U. 8414419011403
1075		Pie nivelador Ø 40 (M10x46) - Levelling leg Ø40 mm. (M10 x 46 mm.)			
	negro - black	1075-3G	000	 x25	U. 8414419011823
1076		Pie nivelador Ø 40 (M8x45) - Levelling leg Ø 40 (M8 x 45 mm.)			
	negro - black	1076-3G	000	 x25	U. 8414419011830
1078		Pomo con espiga Ø 30 (M6x22) - Screw knob Ø30 mm. (M6 x 22 mm.)			
	negro - black	1078-3G	000	 x25	U. 8414419011847
1079		Pomo con espiga Ø 40 (M8x32) - Screw knob Ø40 mm. (M8 x 32 mm.)			
	negro - black	1079-3G	000	 x25	U. 8414419011854
1080		Pomo con espiga Ø 50 (M10x37) - Screw knob Ø 50 mm. (M10 x 37 mm.)			
	negro - black	1080-3G	000	 x25	U. 8414419822788
1081		Pomo con espiga Ø 60 (M10x37) - Screw knob Ø60 mm. (M10 x 37 mm.)			
	negro - black	1081-3G	000	 x25	U. 8414419822795
1082		Pomo triangular con espiga Ø 70 (M10x33) - Triangular screw knob Ø70 mm. (M10 x 33 mm.)			
	negro - black	1082-3G	000	 x25	U. 8414419822801
1141		Agarradores para la cocina 20x20 cm. - Potholders 20x20 cm.			
	topos - Polka dots	1141-4-	000 8414419015227	 x30 	8414419839212
	hojas - leaves	1141-6-	000 8414419015241	 x30 	8414419839236
1148		Guantes horno 30x18 cm. - 30x18 cm oven mitts			
	topos - Polka dots	1148-4-	000 8414419015258	 x24 	8414419839243
	hojas - leaves	1148-6-	000 8414419015272	 x24 	8414419839267
1190		Pinza sujeta-mantel - Table cloth nippers			
	transparente - transparent	1190-0-	000 8414419119000	 x10 	8414419838505
	transparente - transparent	1190-0G	000	 x50	U. 8414419838529
	blanco - white	1190-2-	001 8414419014893	 x10 	8414419838482
	blanco - white	1190-2G	000	 x50	U. 8414419003682









MODELO MODEL	COLOR COLOUR	ARTÍCULO ARTICLE	EAN ARTÍCULO EAN ARTICLE	EMBALAJE PACKING	EAN EMBALAJE EAN PACKING
1191		Arandela para llaves - Key ring			
	surtidas - assorted	1191-0- 000	8414419119109	 x20 	8414419801936
	surtidas - assorted	1191-0G 000		 x100 	8414419003699
	negro - black	1191-3G 000		 x50 	8414419003705
	verde - green	1191-5G 000		 x50 	8414419003712
	rojo - red	1191-6G 000		 x50 	8414419003729
	azul - blue	1191-8G 000		 x50 	8414419003736
	amarillo - yellow	1191-9G 000		 x50 	8414419003743
1192		Llavero porta-etiquetas - Key label holders			
	surtido - assortment	1192-0- 000	8414419119208	 x20 	8414419801943
	surtido - assortment	1192-0G 000		 x70 	8414419003750
	blanco - white	1192-2G 000		 x25 	8414419003767
	negro - black	1192-3G 000		 x25 	8414419003774
	naranja - orange	1192-4G 000		 x25 	8414419003583
	verde - green	1192-5G 000		 x25 	8414419003590
	rojo - red	1192-6G 000		 x25 	8414419003606
	azul - blue	1192-8G 000		 x25 	8414419003613
	amarillo - yellow	1192-9G 000		 x25 	8414419003620
1193		Llavero porta-etiquetas - Key label holders			
	surtidas - assorted	1193-0G 000		 x70 	8414419003637
	blanco - white	1193-2G 000		 x25 	8414419003644
	negro - black	1193-3G 000		 x25 	8414419003651
	naranja - orange	1193-4G 000		 x25 	8414419003668
	verde - green	1193-5G 000		 x25 	8414419003675
	rojo - red	1193-6G 000		 x25 	8414419003514
	azul - blue	1193-8G 000		 x25 	8414419003521
	amarillo - yellow	1193-9G 000		 x25 	8414419003538
1194		Pinza sujeta-mantel metálica - Metallic table cloth nippers			
	acero inox. - stainless steel	1194-1- 000	8414419119413	 x10 	8414419838406
	acero inox. - stainless steel	1194-1G 000		 x50 	8414419838420
1205		Ventosa doble Ø 31 mm - Double suction pad Ø31 mm.			
	transparente - transparent	1205-2- 000	8414419120525	 x10 	8414419801950
1206		Colgador ventosa Ø 33 mm - Suction hook Ø33 mm.			
	surtido - assortment	1206-0- 000	8414419120600	 x10 	8414419801967

MODELO MODEL	COLOR COLOUR	ARTÍCULO ARTICLE	EAN ARTÍCULO EAN ARTICLE	EMBALAJE PACKING	EAN EMBALAJE EAN PACKING
	transparente - transparent	1206-1- 000	8414419120617	 x10  4	8414419835788
	blanco - white	1206-2- 000	8414419120624	 x10  4	8414419801974
1207	 Colgador ventosa Ø 42 mm - Suction hook Ø42 mm.				
	surtido - assortment	1207-0- 000	8414419120709	 x8  4	8414419821460
	transparente - transparent	1207-1- 000	8414419120716	 x8  4	8414419835795
	blanco - white	1207-2- 000	8414419120723	 x8  4	8414419821477
1208	 Colgador ventosa Ø 42 mm articulado - Articulated suction hook Ø42 mm.				
	blanco - white	1208-2- 000	8414419120822	 x8  2	8414419821422
1216	 Colgador ventosa Ø 22 mm - Suction hook Ø22 mm.				
	cromado - chrome	1216-1- 000	8414419121614	 x10  4	8414419802018
1217	 Colgador ventosa Ø 35 mm - Suction hook Ø35 mm.				
	cromado - chrome	1217-1- 000	8414419121713	 x10  4	8414419802025
1218	 Colgador ventosa Ø 45 mm - Suction hook Ø45 mm.				
	cromado - chrome	1218-1- 000	8414419121812	 x10  2	8414419802032
1232	 Ventosa Ø 22 mm sin gancho - Suction pad Ø22 mm.				
	transparente - transparent	1232-2G 000		 x50  u.	8414419008984
1233	 Ventosa Ø 35 mm sin gancho - Suction pad Ø35 mm.				
	transparente - transparent	1233-2G 000		 x50  u.	8414419008991
1234	 Ventosa Ø 45 mm sin gancho - Suction pad Ø45 mm.				
	transparente - transparent	1234-2G 000		 x50  u.	8414419009004
1236	 Ventosa Ø 33 mm sin gancho - Suction pad Ø33 mm.				
	transparente - transparent	1236-2G 000	8414419016002	 x50  u.	8414419009028
1237	 Ventosa Ø 42 mm sin gancho - Suction pad Ø42 mm.				
	transparente - transparent	1237-2G 000	8414419016019	 x50  u.	8414419009011
1250	 Rejilla aluminio 100x100 mm - sección de ventilación 25 cm² - Aluminium air grille 100x100 mm. - 25 cm² ventilation section				
	natural - natural	1250-1G 000	8414419003491	 x10  u.	8414419813106
	natural - natural	1250-1G 001	8414419016262	 x10  u.	8414419846357
	blanco - white	1250-2G 000	8414419003507	 x10  u.	8414419813113
	blanco - white	1250-2G 001	8414419016279	 x10  u.	8414419846364
	madera clara - light wood	1250-3G 000	8414419009035	 x10  u.	8414419812611
	madera clara - light wood	1250-3G 001	8414419016286	 x10  u.	8414419846371
	madera oscura - dark wood	1250-8G 000	8414419003392	 x10  u.	8414419813120

MODELO MODEL	COLOR COLOUR	ARTÍCULO ARTICLE	EAN ARTÍCULO EAN ARTICLE	EMBALAJE PACKING	EAN EMBALAJE EAN PACKING
	madera oscura - dark wood	1250-8G 001	8414419016293	 x10	U. 8414419846388
1251	 Rejilla aluminio 100x200 mm - sección de ventilación 50 cm² - Aluminium air grille 100x200 mm. - 50 cm² ventilation section				
	natural - natural	1251-1G 000	8414419003408	 x10	U. 8414419813137
	natural - natural	1251-1G 001	8414419016873	 x10	U. 8414419844773
	blanco - white	1251-2G 000	8414419003415	 x10	U. 8414419813144
	blanco - white	1251-2G 001	8414419016309	 x10	U. 8414419846395
	madera clara - light wood	1251-3G 000	8414419009042	 x10	U. 8414419812628
	madera clara - light wood	1251-3G 001	8414419016316	 x10	U. 8414419846401
	bronce - bronze	1251-4G 001	8414419016323	 x10	U. 8414419846418
	madera oscura - dark wood	1251-8G 000	8414419003446	 x10	U. 8414419813175
	madera oscura - dark wood	1251-8G 001	8414419016330	 x10	U. 8414419846432
1252	 Rejilla aluminio 200x200 mm - sección de ventilación 125 cm² - Aluminium air grille 200x200 mm. - 125 cm² ventilation section				
	natural - natural	1252-1G 000	8414419003453	 x10	U. 8414419813182
	natural - natural	1252-1G 001	8414419016880	 x10	U. 8414419841031
	blanco - white	1252-2G 000	8414419003460	 x10	U. 8414419813199
	blanco - white	1252-2G 001	8414419016347	 x10	U. 8414419846449
	madera clara - light wood	1252-3G 000	8414419009066	 x10	U. 8414419812635
	madera clara - light wood	1252-3G 001	8414419016354	 x10	U. 8414419846456
	bronce - bronze	1252-4G 001	8414419016361	 x10	U. 8414419846463
	madera oscura - dark wood	1252-8G 000	8414419003330	 x10	U. 8414419813229
	madera oscura - dark wood	1252-8G 001	8414419016378	 x10	U. 8414419846470
1253	 Rejilla aluminio 150x150 mm - sección de ventilación 75 cm² - Aluminium air grille 150x150 mm. - 75 cm² ventilation section				
	natural - natural	1253-1G 000	8414419003347	 x10	U. 8414419813236
	natural - natural	1253-1G 001	8414419016385	 x10	U. 8414419846487
	blanco - white	1253-2G 000	8414419003354	 x10	U. 8414419813243
	blanco - white	1253-2G 001	8414419016392	 x10	U. 8414419846494
	madera clara - light wood	1253-3G 000	8414419009059	 x10	U. 8414419812642
	madera clara - light wood	1253-3G 001	8414419016408	 x10	U. 8414419846500
	bronce - bronze	1253-4G 001	8414419016415	 x10	U. 8414419846517
	madera oscura - dark wood	1253-8G 000	8414419003385	 x10	U. 8414419813274
	madera oscura - dark wood	1253-8G 001	8414419016422	 x10	U. 8414419846524
1254	 Rejilla aluminio 150x300 mm - sección de ventilación 150 cm² - Aluminium air grille 150x300 mm. - 150 cm² ventilation section				
	natural - natural	1254-1G 000	8414419003248	 x10	U. 8414419812659
	natural - natural	1254-1G 001	8414419016439	 x10	U. 8414419846531
	blanco - white	1254-2G 000	8414419003255	 x10	U. 8414419813281

MODELO MODEL	COLOR COLOUR	ARTÍCULO ARTICLE	EAN ARTÍCULO EAN ARTICLE	EMBALAJE PACKING	EAN EMBALAJE EAN PACKING
	blanco - white	1254-2G 001	8414419016446	 x10	u. 8414419846548
	madera clara - light wood	1254-3G 000	8414419009073	 x10	u. 8414419812666
	madera clara - light wood	1254-3G 001	8414419016453	 x10	u. 8414419846555
	madera oscura - dark wood	1254-8G 000	8414419003279	 x10	u. 8414419813304
	madera oscura - dark wood	1254-8G 001	8414419016460	 x10	u. 8414419846562







1255  **Rejilla aluminio 170x170 mm - sección de ventilación 150 cm² - Aluminium air grille 170x170 mm. - 150 cm² ventilation section**

































	natural - natural	1255-1G 000	8414419003286	 x10	u. 8414419813311
	natural - natural	1255-1G 001	8414419016477	 x10	u. 8414419846579
	blanco - white	1255-2G 000	8414419003293	 x10	u. 8414419813328
	blanco - white	1255-2G 001	8414419016484	 x10	u. 8414419846586
	madera clara - light wood	1255-3G 000	8414419009080	 x10	u. 8414419812673
	madera clara - light wood	1255-3G 001	8414419016491	 x10	u. 8414419846593
	bronce - bronze	1255-4G 001	8414419016507	 x10	u. 8414419846609
	madera oscura - dark wood	1255-8G 000	8414419003156	 x10	u. 8414419813359
	madera oscura - dark wood	1255-8G 001	8414419016514	 x10	u. 8414419846616



































1256  **Rejilla aluminio 200x400 mm - sección ventilación 175cm² - Aluminium air grille 200x400 mm. - 175 cm² ventilation section**







































	natural - natural	1256-1G 000	8414419003163	 x10	u. 8414419812680
	natural - natural	1256-1G 001	8414419016897	 x10	u. 8414419844292
	blanco - white	1256-2G 000	8414419003170	 x10	u. 8414419813366
	blanco - white	1256-2G 001	8414419016903	 x10	u. 8414419841147
	madera clara - light wood	1256-3G 000	8414419009097	 x10	u. 8414419812697
	madera clara - light wood	1256-3G 001	8414419016521	 x10	u. 8414419846623
	bronce - bronze	1256-4G 001	8414419016538	 x10	u. 8414419846630
	plata - silver	1256-5G 000	8414419003194	 x10	u. 8414419813373
	plata - silver	1256-5G 001	8414419016545	 x10	u. 8414419846647
	madera oscura - dark wood	1256-8G 000	8414419003217	 x10	u. 8414419813397
	madera oscura - dark wood	1256-8G 001	8414419016552	 x10	u. 8414419846654

1257  **Rejilla aluminio 300x300 mm - sección ventilación 300 cm² - Aluminium air grille 300x300 mm. - 300 cm² ventilation section**

























































	natural - natural	1257-1G 000	8414419003224	 x10	u. 8414419813403
	natural - natural	1257-1G 001	8414419016910	 x10	u. 8414419843523
	blanco - white	1257-2G 000	8414419003231	 x10	u. 8414419813410
	blanco - white	1257-2G 001	8414419016569	 x10	u. 8414419846661
	madera clara - light wood	1257-3G 000	8414419009103	 x10	u. 8414419813427
	madera clara - light wood	1257-3G 001	8414419016576	 x10	u. 8414419846678
	bronce - bronze	1257-4G 001	8414419016583	 x10	u. 8414419846685











MODELO MODEL	COLOR COLOUR	ARTÍCULO ARTICLE	EAN ARTÍCULO EAN ARTICLE	EMBALAJE PACKING	EAN EMBALAJE EAN PACKING
	plata - silver	1257-5G 000	8414419003071	 x10	u. 8414419813441
	plata - silver	1257-5G 001	8414419016590	 x10	u. 8414419846692
	madera oscura - dark wood	1257-8G 000	8414419003095	 x10	u. 8414419813465
	madera oscura - dark wood	1257-8G 001	8414419016606	 x10	u. 8414419846715
1259		Rejilla aluminio 150x150 marco y mosquitera - sección ventilación 35 cm² - Aluminium air grille 150x150 mm with flyscreen - 35 cm² ventilation section			
	natural - natural	1259-1G 000	8414419010260	 x10	u. 8414419813496
	natural - natural	1259-1G 001	8414419016613	 x10	u. 8414419846722
	blanco - white	1259-2G 000	8414419003125	 x10	u. 8414419813502
	blanco - white	1259-2G 001	8414419016620	 x10	u. 8414419846739
1260		Rejilla aluminio 150x150 mm con marco - Aluminium air grille 150x150mm with frame			
	blanco - white	1260-2G 000	8414419003132	 x10	u. 8414419813519
	blanco - white	1260-2G 001	8414419016637	 x10	u. 8414419846746
1261		Rejilla aluminio regulable 170x170 mm - sección de ventilación 80 cm² - Adjustable aluminium air grille 170x170 mm - 80 cm² ventilation section			
	natural - natural	1261-1G 000	8414419002999	 x10	u. 8414419813526
	blanco - white	1261-2G 000	8414419003002	 x10	u. 8414419813533
1262		Rejilla shun 260x132 mm con mosquitera - sección ventilación 54 cm² - Shunt air grille 260x132 mm with flyscreen - 54 cm² ventilation section			
	blanco - white	1262-2G 001	8414419003019	 x10	u. 8414419813540
	blanco - white	1262-2G 002	8414419016866	 x10	u. 8414419847064
1264		Rejilla aluminio 100x300 mm - sección de ventilación 80 cm² - Aluminium air grille 100x300 mm. - 80 cm² ventilation section			
	natural - natural	1264-1G 000	8414419003033	 x10	u. 8414419813557
	natural - natural	1264-1G 001	8414419016644	 x10	u. 8414419846753
	blanco - white	1264-2G 000	8414419003040	 x10	u. 8414419813564
	blanco - white	1264-2G 001	8414419016651	 x10	u. 8414419846760
1265		Rejilla aluminio 150x150 mm - sección de ventilación 75 cm² - Aluminium air grille 150x150 mm. - 75cm² ventilation section			
	natural - natural	1265-1G 000	8414419003057	 x100	u. 8414419813571
	blanco - white	1265-2G 000	8414419002920	 x100	u. 8414419813588
1266		Rejilla aluminio 170x170 mm - sección de ventilación 150 cm² - Aluminium air grille 170x170 mm - 150cm² ventilation section			
	natural - natural	1266-1G 000	8414419003903	 x100	u. 8414419813595
	blanco - white	1266-2G 000	8414419003910	 x100	u. 8414419813601
1267		Rejilla redonda con mosquitera Ø 100-130 mm. - Round air grille with fly screen Ø100-130mm.			
	blanca - white	1267-2- 000	8414419013100	 x10 	8414419831919
1270		Rejilla aluminio adhesiva 150x150 mm - sección de ventilación 75 cm² - Adhesive aluminium air grille 150x150 mm - 75 cm² ventilation section			

MODELO MODEL	COLOR COLOUR	ARTÍCULO ARTICLE	EAN ARTÍCULO EAN ARTICLE	EMBALAJE PACKING	EAN EMBALAJE EAN PACKING
	natural - natural	1270-1G 000	8414419002937	 x10 u.	8414419812703
	natural - natural	1270-1G 001	8414419016668	 x10 u.	8414419846777
	blanco - white	1270-2G 000	8414419002944	 x10 u.	8414419813618
	blanco - white	1270-2G 001	8414419016941	 x10 u.	8414419848931
1271		Rejilla aluminio adhesiva 170x170 mm - sección de ventilación 150 cm² - Adhesive aluminium air grille 170x170 mm - 150 cm² ventilation section			
	natural - natural	1271-1G 000	8414419002951	 x10 u.	8414419813625
	natural - natural	1271-1G 001	8414419016675	 x10 u.	8414419846784
	blanco - white	1271-2G 000	8414419002968	 x10 u.	8414419813632
	blanco - white	1271-2G 001	8414419016682	 x10 u.	8414419846791
1272		Rejilla aluminio adhesiva 200x200 mm - sección de ventilación 125 cm² - Adhesive aluminium air grille 200x200 mm - 125cm² ventilation section			
	natural - natural	1272-1G 000	8414419002975	 x10 u.	8414419813649
	natural - natural	1272-1G 001	8414419016705	 x10 u.	8414419846814
	blanco - white	1272-2G 000	8414419002982	 x10 u.	8414419813656
	blanco - white	1272-2G 001	8414419016712	 x10 u.	8414419846821
1273		Rejilla aluminio 100x100 mm. con mosquitera - Aluminium air grille 100x100 mm. with fly screen			
	natural - natural	1273-1G 000	8414419127319	 x10 u.	8414419839526
	natural - natural	1273-1G 001	8414419016699	 x10 u.	8414419846807
	blanco - white	1273-2G 000	8414419127326	 x10 u.	8414419839533
	blanco - white	1273-2G 001	8414419016927	 x10 u.	8414419841048
1274		Rejilla aluminio 100x200 mm. con mosquitera - Aluminium air grille 100x200 mm. with fly screen			
	natural - natural	1274-1G 000	8414419127418	 x10 u.	8414419839380
	natural - natural	1274-1G 001	8414419016729	 x10 u.	8414419846845
	blanco - white	1274-2G 000	8414419127425	 x10 u.	8414419839397
	blanco - white	1274-2G 001	8414419016736	 x10 u.	8414419846852
1275		Rejilla aluminio 150x150 mm. con mosquitera - Aluminium air grille 150x150 mm. with fly screen			
	natural - natural	1275-1G 000	8414419127517	 x10 u.	8414419839403
	natural - natural	1275-1G 001	8414419016743	 x10 u.	8414419846869
	blanco - white	1275-2G 000	8414419127524	 x10 u.	8414419839410
	blanco - white	1275-2G 001	8414419016750	 x10 u.	8414419846883
1276		Rejilla aluminio 200x200 mm. con mosquitera - Aluminium air grille 200x200 mm. with fly screen			
	natural - natural	1276-1G 000	8414419127616	 x10 u.	8414419839427
	natural - natural	1276-1G 001	8414419016767	 x10 u.	8414419846906
	blanco - white	1276-2G 000	8414419127623	 x10 u.	8414419839434
	blanco - white	1276-2G 001	8414419016774	 x10 u.	8414419846913



























MODELO MODEL	COLOR COLOUR	ARTÍCULO ARTICLE	EAN ARTÍCULO EAN ARTICLE	EMBALAJE PACKING	EAN EMBALAJE EAN PACKING
1277		Rejilla aluminio 150x300 mm. con mosquitera - Aluminium air grille 150x300 mm. with fly screen			
	natural - natural	1277-1G 000	8414419127715	 x10	u. 8414419839441
	natural - natural	1277-1G 001	8414419016781	 x10	u. 8414419846920
	blanco - white	1277-2G 000	8414419127722	 x10	u. 8414419839458
	blanco - white	1277-2G 001	8414419016798	 x10	u. 8414419846944
1278		Rejilla aluminio 170x170 mm. con mosquitera - Aluminium air grille 170x170 mm. with fly screen			
	natural - natural	1278-1G 000	8414419127814	 x10	u. 8414419839465
	natural - natural	1278-1G 001	8414419016804	 x10	u. 8414419846968
	blanco - white	1278-2G 000	8414419127821	 x10	u. 8414419839472
	blanco - white	1278-2G 001	8414419016811	 x10	u. 8414419846975
1279		Rejilla aluminio 200x400 mm. con mosquitera - Aluminium air grille 200x400 mm. with fly screen			
	natural - natural	1279-1G 000	8414419127913	 x10	u. 8414419839489
	natural - natural	1279-1G 001	8414419016828	 x10	u. 8414419846982
	blanco - white	1279-2G 000	8414419127920	 x10	u. 8414419839496
	blanco - white	1279-2G 001	8414419016835	 x10	u. 8414419847002
1280		Rejilla aluminio 300x300 mm. con mosquitera - Aluminium air grille 300x300 mm. amb mosquitera			
	natural - natural	1280-1G 000	8414419128019	 x10	u. 8414419839502
	natural - natural	1280-1G 001	8414419016842	 x10	u. 8414419847026
	blanco - white	1280-2G 000	8414419128026	 x10	u. 8414419839519
	blanco - white	1280-2G 001	8414419016859	 x10	u. 8414419847040
1290		Colgador adherente reutilizable base 60x47 mm. - Re-usable sticky hook, base 60x47 mm.			
transparente - transparent	1290-0- 000	8414419012905	 x10	 1 8414419830745	
1291		Colgador adherente reutilizable base 80x62 mm. - Re-usable sticky hook, base 80x62 mm.			
transparente - transparent	1291-0- 000	8414419129108	 x10	 1 8414419830363	
1292		Colgador Stick&Go! con gancho móvil - Reusable sticky hanger with swinging hook			
	transparente - transparent	1292-0- 000	8414419015531	 x10	 1 8414419840836
	acero inox. - stainless steel	1292-7- 000	8414419015548	 x10	 1 8414419840850
1293		Colgador Stick&Go! con 3 ganchos móviles - Reusable sticky hanger with 3 swinging hooks			
	transparente - transparent	1293-0- 000	8414419015555	 x6	 1 8414419840874
	acero inox. - stainless steel	1293-7- 000	8414419015562	 x6	 1 8414419840898
1294		Soporte de fijación con rosca Stick&Go! - Reusable fixing bracket with thread			
transparente - transparent	1294-0- 000	8414419015579	 x10	 2 8414419840911	



MODELO MODEL	COLOR COLOUR	ARTÍCULO ARTICLE	EAN ARTÍCULO EAN ARTICLE	EMBALAJE PACKING	EAN EMBALAJE EAN PACKING
1295		Colgador escoba Stick&Go! - Reusable adhesive broom hook			
	blanco - white	1295-0- 000	8414419129504	 x8 	8414419840812
	negro - black	1295-3- 000	8414419129535	 x8 	8414419841451
1296		Colgador adherente reutilizable "J" - Re-usable sticky hook "J"			
	transparente - transparent	1296-0- 000	8414419129603	 x6 	8414419846241
1308		Depurador agua - Water filter			
	chromo-blanco - chrome-white	1308-1- 000	8008520013083	 x6 	8414419802131
1310		Recambio depurador - Water filter replacement			
	blanco - white	1310-2- 000	8008520013106	 x10 	8414419802148
1320		Aireador con rótula. Fijación abrazadera - Swivel tap aerator. Fully adaptable clamp fitting.			
	chromo-blanco - chrome-white	1320-1- 000	8414419011861	 x8 	8414419824850
1321		Aireador con rótula. Fijación rosca - Swivel tap aerator. Fitted using an H22 thread and M24 adaptor.			
	chromo-blanco - chrome-white	1321-1- 000	8414419011878	 x8 	8414419824874
1322		Aireador con tubo flexible. Fijación abrazadera - Aerator with flexible hose. Fully adaptable clamp fitting.			
	chromo-blanco - chrome-white	1322-1- 000	8414419011960	 x6 	8414419824997
1323		Aireador con tubo flexible metálico. Fijación rosca - Aerator with flexible metal hose. Fitted using an H22 thread and M24 adaptor.			
	chromado - chrome	1323-1- 000	8414419011977	 x6 	8414419825017
1324		Aireador con tubo flexible. Fijación rosca - Aerator with flexible hose. Fitted using an H22 thread and M24 adaptor.			
	chromo-blanco - chrome-white	1324-1- 000	8414419011984	 x6 	8414419825031
1325		Aireador de latón cromado. Rosca H22 - Brass aerator. H22 thread fitting.			
	chromado - chrome	1325-1- 000	8414419012004	 x10 	8414419825079
1326		Aireador de latón cromado. Rosca M24 - Brass aerator. M24 thread fitting.			
	chromado - chrome	1326-1- 000	8414419011991	 x10 	8414419825055
1327		Aireador de latón cromado con rótula. Rosca M24 - Brass swivel aerator. Fitted using an M24 adaptor.			
	chromado - chrome	1327-1- 000	8414419012011	 x10 	8414419825093
1328		Aireador de latón cromado con rótula. Rosca H22 - Brass swivel aerator. Fitted using an H22 thread.			
	chromado - chrome	1328-1- 000	8414419012028	 x10 	8414419825116
1340		Funda plancha COTTON 130x48 cm. - 130x48 cm COTTON iron cover.			
	topos - Polka dots	1340-5- 000	8414419015166	 x40 	8414419839151
	círculos - circles	1340-6- 000	8414419015173	 x40 	8414419839168

MODELO MODEL	COLOR COLOUR	ARTÍCULO ARTICLE	EAN ARTÍCULO EAN ARTICLE	EMBALAJE PACKING	EAN EMBALAJE EAN PACKING
	mandala - mandala	1340-7- 000	8414419015180	 x40 	8414419839175
1341		Funda plancha METAL 130x48cm. - 130x48 cm METAL iron cover.			
	metalizado - metallized	1341-1- 000	8414419013216	 x40 	8414419832053
1342		Funda plancha ELASTIC FIT 135x50 cm. - 135x50 cm ELASTIC FIT iron cover.			
	hojas - leaves	1342-1- 001	8414419013223	 x25 	8414419832060
	flores - flowers	1342-3- 001	8414419013247	 x25 	8414419832084
	topos - Polka dots	1342-4- 000	8414419013254	 x25 	8414419832091
1343		Funda plancha COTTON PLUS 130x48 cm. - 130x48 cm COTTON PLUS iron cover.			
	rayas - stripes	1343-5- 000	8414419014824	 x30 	8414419825932
	círculos - circles	1343-6- 000	8414419015197	 x30 	8414419839182
	siluetas - silhouettes	1343-7- 000	8414419015203	 x30 	8414419839199
1344		Funda plancha PARKING PROTEK 130x48cm. - 130x48 cm PARKING PROTEK iron cover.			
	peces - fish	1344-1- 000	8414419013308	 x30 	8414419832145
	círculos - circles	1344-2- 000	8414419013315	 x30 	8414419832152
	hojas - leaves	1344-3- 000	8414419134430	 x30 	8414419844780
1345		Funda plancha METAL PLUS 130x48cm. - 130x48 cm METAL PLUS iron cover.			
	pictos azules - blue drawing	1345-1- 000	8414419013322	 x30 	8414419832169
	pictos verdes - green drawings	1345-2- 000	8414419013339	 x30 	8414419832176
	aves - birds	1345-5- 000	8414419134553	 x30 	8414419843585
1346		Funda plancha TITANIUM 130x48cm. - 130x48 cm TITANIUM iron cover.			
	flores cerezo - cherry tree flowers	1346-1- 000	8414419013360	 x30 	8414419832206
	siluetas - silhouettes	1346-3- 001	8414419013384	 x30 	8414419832220
	hojas - leaves	1346-4- 000	8414419014831	 x30 	8414419838123
1347		Funda plancha POWER VAP 130x48 cm. - 130x48 cm POWER VAP iron cover			
	topos - Polka dots	1347-1- 000	8414419013469	 x25 	8414419833050
	rayas - stripes	1347-2- 000	8414419013483	 x25 	8414419833074
	flores - flowers	1347-5- 000	8414419134751	 x25 	8414419843592
1347L		Funda plancha POWER VAP 140x55cm. - 140x55 cm POWER VAP iron cover			
	topos - Polka dots	1347L1- L00	8414419013476	 x20 	8414419833067
	rayas - stripes	1347L2- L00	8414419013537	 x20 	8414419833128
	flores - flowers	1347L5- L00	8414419015975	 x20 	8414419843608
1348		Funda plancha E-COVER 130x48cm. - 130x48 cm E-COVER iron cover.			
	beige - beige	1348-1- 000	8414419134812	 x25 	8414419844797









































MODELO MODEL	COLOR COLOUR	ARTÍCULO ARTICLE	EAN ARTÍCULO EAN ARTICLE	EMBALAJE PACKING	EAN EMBALAJE EAN PACKING	
1416		Contera redonda interior Ø 16 mm - Inner round ferrule Ø16 mm.			 x50	u. 8414419002876
	negro - black	1416-3G	000			
1418		Contera redonda interior Ø 18 mm - Inner round ferrule Ø18 mm.			 x50	u. 8414419009592
	blanco - white	1418-2G	000			
	negro - black	1418-3G	000	 x50	u. 8414419002883	
1420		Contera redonda interior Ø 20 mm - Inner round ferrule Ø20 mm.				 x50
	blanco - white	1420-2G	000			
	negro - black	1420-3-	001	8414419142039	 x10	 4 8414419842267
	negro - black	1420-3G	000	 x50	u. 8414419002890	
1422		Contera redonda interior Ø 22 mm - Inner round ferrule Ø22 mm.			 x50	u. 8414419009615
	blanco - white	1422-2G	000			
	negro - black	1422-3-	001	8414419142237	 x10	 4 8414419842632
	negro - black	1422-3G	000	 x50	u. 8414419002906	
1425		Contera redonda interior Ø 25 mm - Inner round ferrule Ø25 mm.			 x50	u. 8414419009622
	blanco - white	1425-2G	000			
	negro - black	1425-3-	001	8414419142534	 x10	 4 8414419842656
	negro - black	1425-3G	000	 x50	u. 8414419002913	
1428		Contera redonda interior Ø 28 mm - Inner round ferrule Ø28 mm.			 x50	u. 8414419009639
	blanco - white	1428-2G	000			
	negro - black	1428-3-	001	8414419142831	 x10	 4 8414419842670
	negro - black	1428-3G	000	 x50	u. 8414419002821	
1430		Contera redonda interior Ø 30 mm - Inner round ferrule Ø30 mm.			 x50	u. 8414419009646
	blanco - white	1430-2G	000			
	negro - black	1430-3-	001	8414419143036	 x10	 4 8414419842694
	negro - black	1430-3G	000	 x50	u. 8414419002838	
1432		Contera redonda interior Ø 32 mm - Inner round ferrule Ø32 mm.			 x50	u. 8414419002845
1435		Contera redonda interior Ø 35 mm - Inner round ferrule Ø35 mm.			 x50	u. 8414419002852
1440		Tope adhesivo de madera y con tornillo - Adhesive wooden door stop with screws			 x10	 1 8414419818019
	sapelly - sapelly	1440-0-	001	8414419144002		
	roble - oak	1440-3-	001	8414419144033	 x10	 1 8414419818026

MODELO MODEL	COLOR COLOUR	ARTÍCULO ARTICLE	EAN ARTÍCULO EAN ARTICLE	EMBALAJE PACKING	EAN EMBALAJE EAN PACKING
	haya - beech	1440-8- 001	8414419144088	 x10 	8414419818033
1443		Contera redonda interior Ø 40 mm - Inner round ferrule Ø40 mm.			
	negro - black	1443-3G 000		 x50 	8414419002791
1444		Contera redonda interior Ø 45 mm - Inner round ferrule Ø45 mm.			
	negro - black	1444-3G 000		 x50 	8414419002807
1446		Contera redonda interior Ø 60 mm - Inner round ferrule Ø 60 mm			
	negro - black	1446-3G 000		 x100 	8414419013568
1448		Contera redonda interior Ø 80 mm - Inner round ferrule Ø 80 mm			
	negro - black	1448-3G 000		 x25 	8414419848399
1450		Contera redonda interior Ø 50 mm - Inner round ferrule Ø50 mm.			
	negro - black	1450-3G 000		 x50 	8414419002814
1470		Tope de madera semiesferico y adhesivo - Semispherical adhesive wooden door stop			
	roble - oak	1470-3- 001	8414419147034	 x12 	8414419818057
	roble - oak	1470-3P 000	8414419009448	 x25 	8414419810518
1472		Colgador madera 2 ganchos - Two hook rack in wood			
	sapelly - sapelly	1472-0- 000	8414419147201	 x6 	8414419821484
	haya - beech	1472-8- 000	8414419147287	 x6 	8414419821491
1473		Colgador madera 3 ganchos - Three hook rack in wood			
	sapelly - sapelly	1473-0- 000	8414419147300	 x6 	8414419821026
	haya - beech	1473-8- 000	8414419147386	 x6 	8414419821033
1516	 Ø 16 mm	Contera redonda exterior Ø 16 mm - Outer round-shaped tip Ø 16 mm			
	transparente - transparent	1516-0- 000	8414419151604	 x10 	8414419843370
	transparente - transparent	1516-0G 000		 x50 	8414419843479
1518	 Ø 18 mm	Contera redonda exterior Ø 18 mm - Outer round-shaped tip Ø 18 mm			
	transparente - transparent	1518-0- 000	8414419151802	 x10 	8414419843394
	transparente - transparent	1518-0G 000		 x50 	8414419843486
1520	 Ø 20 mm	Contera redonda exterior Ø 20 mm - Outer round-shaped tip Ø 20 mm			
	transparente - transparent	1520-0- 000	8414419152007	 x10 	8414419843417
	transparente - transparent	1520-0G 000		 x50 	8414419843493
1522	 Ø 22 mm	Contera redonda exterior Ø 22 mm - Outer round-shaped tip Ø 22 mm			
	transparente - transparent	1522-0- 000	8414419152205	 x10 	8414419843431

MODELO MODEL	COLOR COLOUR	ARTÍCULO ARTICLE	EAN ARTÍCULO EAN ARTICLE	EMBALAJE PACKING	EAN EMBALAJE EAN PACKING
	transparente - transparent	1522-0G 000		 x50	u. 8414419843509
1525	 Contera redonda exterior Ø 25 mm - Outer round-shaped tip Ø 25 mm				
	transparente - transparent	1525-0- 000	8414419152502	 x10	 8414419843455
	transparente - transparent	1525-0G 000		 x50	u. 8414419843516
1610	 Contera redonda exterior flexible Ø 10 mm - Flexible outer round ferrule Ø10 mm.				
	negro - black	1610-3G 000		 x50	u. 8414419002760
1612	 Contera redonda exterior flexible Ø 12 mm - Flexible outer round ferrule Ø12 mm.				
	negro - black	1612-3G 000		 x50	u. 8414419002777
1614	 Contera redonda exterior flexible Ø 14 mm - Flexible outer round ferrule Ø14 mm.				
	negro - black	1614-3G 000		 x50	u. 8414419002784
1616	 Contera redonda exterior flexible Ø 16 mm - Flexible outer round ferrule Ø16 mm.				
	negro - black	1616-3G 000		 x50	u. 8414419002685
1618	 Contera redonda exterior flexible Ø 18 mm - Flexible outer round ferrule Ø18 mm.				
	negro - black	1618-3G 000		 x50	u. 8414419002692
1620	 Contera redonda exterior flexible Ø 20 mm - Flexible outer round ferrule Ø20 mm.				
	negro - black	1620-3G 000		 x50	u. 8414419002708
1622	 Contera redonda exterior flexible Ø 22 mm - Flexible outer round ferrule Ø22 mm.				
	negro - black	1622-3G 000		 x50	u. 8414419002715
1625	 Contera redonda exterior flexible Ø 25 mm - Flexible outer round ferrule Ø25 mm.				
	negro - black	1625-3G 000		 x50	u. 8414419002722
1628	 Contera redonda exterior flexible Ø 28 mm - Flexible outer round ferrule Ø28 mm.				
	negro - black	1628-3G 000		 x50	u. 8414419002739
1630	 Contera redonda exterior flexible Ø 30 mm - Flexible outer round ferrule Ø30 mm.				
	negro - black	1630-3G 000		 x50	u. 8414419002746
1632	 Contera redonda exterior flexible Ø 32 mm - Flexible outer round ferrule Ø32 mm.				
	negro - black	1632-3- 001	8414419163232	 x10	 8414419842717
	negro - black	1632-3G 000		 x50	u. 8414419002753
1635	 Contera redonda exterior flexible Ø 35 mm - Flexible outer round ferrule Ø35 mm.				
	negro - black	1635-3- 001	8414419163539	 x10	 8414419842731
	negro - black	1635-3G 000		 x50	u. 8414419002616













































MODELO MODEL	COLOR COLOUR	ARTÍCULO ARTICLE	EAN ARTÍCULO EAN ARTICLE	EMBALAJE PACKING	EAN EMBALAJE EAN PACKING
1640		Contera redonda exterior flexible Ø 40 mm - Flexible outer round ferrule Ø40 mm.			
	negro - black	1640-3-	001 8414419164031	 x9  4	8414419842755
	negro - black	1640-3G	000	 x50  u.	8414419002623
1645		Contera redonda exterior flexible Ø 45 mm - Flexible outer round ferrule Ø45 mm			
	negro - black	1645-3G	000	 x50  u.	8414419002630
1650		Contera redonda exterior flexible Ø 50 mm - Flexible outer round ferrule Ø50 mm.			
	negro - black	1650-3G	000	 x50  u.	8414419002647
1710		Contera exterior con arandela Ø 10 mm - Outer ferrule with washer Ø10 mm.			
	blanco - white	1710-2G	000	 x50  u.	8414419002654
	negro - black	1710-3-	001 8414419171039	 x10  8	8414419842779
	negro - black	1710-3G	000	 x50  u.	8414419002661
1712		Contera exterior con arandela Ø 12 mm - Outer ferrule with washer Ø12 mm.			
	blanco - white	1712-2G	000	 x50  u.	8414419002678
	negro - black	1712-3-	001 8414419171237	 x10  8	8414419842793
	negro - black	1712-3G	000	 x50  u.	8414419002548
1714		Contera exterior con arandela Ø 14 mm - Outer ferrule with washer Ø14 mm.			
	blanco - white	1714-2G	000	 x50  u.	8414419002555
	negro - black	1714-3-	001 8414419171435	 x10  8	8414419842816
	negro - black	1714-3G	000	 x50  u.	8414419002562
1716		Contera exterior con arandela Ø 16 mm - Outer ferrule with washer Ø16 mm.			
	blanco - white	1716-2G	000	 x50  u.	8414419002579
	negro - black	1716-3-	001 8414419171633	 x10  8	8414419842830
	negro - black	1716-3G	000	 x50  u.	8414419002586
1718		Contera exterior con arandela Ø 18 mm - Outer ferrule with washer Ø18 mm.			
	blanco - white	1718-2G	000	 x50  u.	8414419002593
	negro - black	1718-3-	001 8414419171831	 x10  8	8414419842854
	negro - black	1718-3G	000	 x50  u.	8414419002609
1720		Contera exterior con arandela Ø 20 mm - Outer ferrule with washer Ø20 mm.			
	blanco - white	1720-2G	000	 x50  u.	8414419002470
	negro - black	1720-3-	001 8414419172036	 x10  4	8414419842878
	negro - black	1720-3G	000	 x50  u.	8414419002487
1722		Contera exterior con arandela Ø 22 mm - Outer ferrule with washer Ø22 mm.			





















































MODELO MODEL	COLOR COLOUR	ARTÍCULO ARTICLE	EAN ARTÍCULO EAN ARTICLE	EMBALAJE PACKING	EAN EMBALAJE EAN PACKING
	blanco - white	1722-2G 000		 x50	u. 8414419002494
	negro - black	1722-3- 001	8414419172234	 x10	 4 8414419842892
	negro - black	1722-3G 000		 x50	u. 8414419002500
1725		Contera exterior con arandela Ø 25 mm - Outer ferrule with washer Ø25 mm.			
	blanco - white	1725-2G 000		 x50	u. 8414419002517
	negro - black	1725-3- 001	8414419172531	 x10	 4 8414419842915
	negro - black	1725-3G 000		 x50	u. 8414419002524
1728		Contera exterior con arandela Ø 28 mm - Outer ferrule with washer Ø28 mm.			
	blanco - white	1728-2G 000		 x50	u. 8414419002531
	negro - black	1728-3- 001	8414419172838	 x10	 4 8414419842939
	negro - black	1728-3G 000		 x50	u. 8414419002395
1730		Contera exterior con arandela Ø 30 mm - Outer ferrule with washer Ø30 mm.			
	blanco - white	1730-2G 000		 x50	u. 8414419002401
	negro - black	1730-3- 001	8414419173033	 x10	 4 8414419842953
	negro - black	1730-3G 000		 x50	u. 8414419002418
1810		Contera interior ovalada 15x25 mm - Inner oval ferrule 15x25 mm.			
	negro - black	1810-3G 000		 x50	u. 8414419002425
1812		Contera interior ovalada 15x30 mm - Inner oval ferrule 15x30 mm.			
	negro - black	1812-3G 000		 x50	u. 8414419002432
1814		Contera interior ovalada 20x40 mm - Inner oval ferrule 20x40 mm.			
	negro - black	1814-3G 000		 x50	u. 8414419002449
1816		Contera interior cuadrada 16 mm - Inner square ferrule 16 mm.			
	negro - black	1816-3G 000		 x50	u. 8414419002456
1818		Contera interior cuadrada 18 mm - Inner square ferrule 18 mm.			
	negro - black	1818-3G 000		 x50	u. 8414419002463
1820		Contera interior cuadrada 20 mm - Inner square ferrule 20 mm.			
	negro - black	1820-3- 001	8414419182035	 x10	 4 8414419842977
	negro - black	1820-3G 000		 x50	u. 8414419002296
1822		Contera interior cuadrada 22 mm - Inner square ferrule 22 mm.			
	negro - black	1822-3G 000		 x50	u. 8414419002302
1825		Contera interior cuadrada 25 mm - Inner square ferrule 25 mm.			
	negro - black	1825-3- 001	8414419182530	 x10	 4 8414419842991















































MODELO MODEL	COLOR COLOUR	ARTÍCULO ARTICLE	EAN ARTÍCULO EAN ARTICLE	EMBALAJE PACKING	EAN EMBALAJE EAN PACKING
	negro - black	1825-3G 000		 x50	u. 8414419002319
1830		Contera interior cuadrada 30 mm - Inner square ferrule 30 mm.			
	negro - black	1830-3- 001	8414419183032	 x10	 4 8414419843011
	negro - black	1830-3G 000		 x50	u. 8414419002326
1835		Contera interior cuadrada 35 mm - Inner square ferrule 35 mm.			
	negro - black	1835-3- 001	8414419183537	 x10	 4 8414419843035
	negro - black	1835-3G 000		 x50	u. 8414419002333
1840		Contera interior cuadrada 40 mm - Inner square ferrule 40 mm.			
	negro - black	1840-3- 001	8414419184039	 x9	 4 8414419843059
	negro - black	1840-3G 000		 x50	u. 8414419002340
1845		Contera interior cuadrada 45 mm - Inner square ferrule 45 mm.			
	negro - black	1845-3G 000		 x50	u. 8414419002357
1847		Contera exterior goma base ancha y efecto ventosa Ø 19 mm - Exterior rubber ferrule Ø 19mm. with wide base and washer			
	negro - black	1847-3- 000	8414419184732	 x8	 1 8414419836518
	negro - black	1847-3G 000		 x10	u. 8414419835429
	gris - grey	1847-7- 000	8414419184770	 x8	 1 8414419836532
	gris - grey	1847-7G 000		 x10	u. 8414419835436
1848		Contera exterior goma base ancha y efecto ventosa Ø 22 mm - Exterior rubber ferrule Ø 22mm. with wide base and washer			
	negro - black	1848-3- 000	8414419184831	 x8	 1 8414419836556
	negro - black	1848-3G 000		 x10	u. 8414419835443
	gris - grey	1848-7- 000	8414419184879	 x8	 1 8414419836570
	gris - grey	1848-7G 000		 x10	u. 8414419835450
1849		Contera exterior goma Ø 25mm. para andadores - Exterior rubber ferrule Ø25mm with washer for walking frames			
	negro - black	1849-3- 000	8414419184930	 x8	 2 8414419836594
	negro - black	1849-3G 000		 x25	u. 8414419836396
	gris - grey	1849-7- 000	8414419014374	 x8	 2 8414419836617
	gris - grey	1849-7G 000		 x25	u. 8414419836426
1850		Contera interior cuadrada 50 mm - Inner square ferrule 50 mm.			
	negro - black	1850-3G 000		 x50	u. 8414419002364
1851		Contera interior rectangular 10x20 mm - Inner rectangular ferrule 10x20 mm.			
	negro - black	1851-3G 000		 x50	u. 8414419002371
1852		Contera interior rectangular 10x25 mm - Inner rectangular ferrule 10x25 mm.			





















































MODELO MODEL	COLOR COLOUR	ARTÍCULO ARTICLE	EAN ARTÍCULO EAN ARTICLE	EMBALAJE PACKING	EAN EMBALAJE EAN PACKING
	negro - black	1852-3G 000		 x50	u. 8414419002388
1853	 Contera interior rectangular 15x20 mm - Inner rectangular ferrule 15x20 mm.				
	negro - black	1853-3G 000		 x50	u. 8414419002197
1854	 Contera interior rectangular 15x25 mm - Inner rectangular ferrule 15x25 mm.				
	negro - black	1854-3G 000		 x50	u. 8414419002203
1855	 Contera interior rectangular 15x30 mm - Inner rectangular ferrule 15x30 mm.				
	negro - black	1855-3G 000		 x50	u. 8414419002210
1856	 Contera interior rectangular 20x30 mm - Inner rectangular ferrule 20x30 mm.				
	negro - black	1856-3G 000		 x50	u. 8414419002227
1857	 Contera interior rectangular 20x35 mm - Inner rectangular ferrule 20x35 mm.				
	negro - black	1857-3G 000		 x50	u. 8414419002234
1858	 Contera interior rectangular 20x40 mm - Inner rectangular ferrule 20x40 mm.				
	negro - black	1858-3G 000		 x50	u. 8414419002241
1859	 Contera interior rectangular 20x50 mm - Inner rectangular ferrule 20x50 mm.				
	negro - black	1859-3G 000		 x50	u. 8414419002258
1860	 Contera interior rectangular 30x40 mm - Inner rectangular ferrule 30x40 mm.				
	negro - black	1860-3G 000		 x50	u. 8414419002265
1861	 Contera exterior goma Ø 17mm. con arandela para muletas - Outer rubber ferrule Ø17 mm.				
	negro - black	1861-3- 000	8414419186132	 x8	 2 8414419836631
	negro - black	1861-3G 001	8414419013575	 x25	u. 8414419002272
1862	 Contera exterior goma Ø 19mm. con arandela para muletas - Outer rubber ferrule Ø19 mm.				
	negro - black	1862-3- 000	8414419186231	 x8	 2 8414419836655
	negro - black	1862-3G 001		 x25	u. 8414419002289
	gris - grey	1862-7- 000	8414419186279	 x8	 2 8414419836679
	gris - grey	1862-7G 000		 x25	u. 8414419835405
1863	 Contera exterior goma Ø 21mm. con arandela para muletas - Outer rubber ferrule Ø21 mm.				
	negro - black	1863-3- 000	8414419186330	 x8	 2 8414419836693
	negro - black	1863-3G 001		 x25	u. 8414419006867
	gris - grey	1863-7- 000	8414419186378	 x8	 2 8414419836716
	gris - grey	1863-7G 000		 x25	u. 8414419835412
1864	 Contera interior 20x50 mm para escalera - Inner ferrule for ladder 20x50 mm.				

MODELO MODEL	COLOR COLOUR	ARTÍCULO ARTICLE	EAN ARTÍCULO EAN ARTICLE	EMBALAJE PACKING	EAN EMBALAJE EAN PACKING
	negro - black	1864-3G 000		 x50	u. 8414419006874
1865		Contera interior rectangular 40x60 mm - Inner rectangular ferrule 40x60 mm.			
	negro - black	1865-3G 000		 x50	u. 8414419006881
1866		Contera interior rectangular 30x50 mm - Inner rectangular ferrule 30x50 mm.			
	negro - black	1866-3G 000		 x50	u. 8414419006898
1867		Contera interior rectangular 30x80 mm - Inner rectangular ferrule 30x80 mm.			
	negro - black	1867-3G 000		 x50	u. 8414419009950
1868		Contera interior rectangular 40x80 mm - Inner rectangular ferrule 40x80 mm.			
	negro - black	1868-3G 000		 x50	u. 8414419006904
1869		Contera interior cuadrada 60 mm - Inner square ferrule 60 mm.			
	negro - black	1869-3G 000		 x50	u. 8414419007758
1870		Contera abrazadera circular para tubo Ø 22-25 mm - Round clamp ferrule for tube of Ø22-25 mm.			
	negro - black	1870-3G 000		 x50	u. 8414419006911
1871		Contera abrazadera longitudinal para tubo Ø 22-25 mm - Longitudinal clamp ferrule for tube of Ø22-25 mm.			
	negro - black	1871-3G 000		 x50	u. 8414419006928
1876		Contera doble alojamiento Ø 16 mm - Double ferrule Ø 16 mm			
	blanco - white	1876-2G 000		 x50	u. 8414419007017
1878		Contera doble alojamiento Ø 18 mm - Double ferrule Ø 18 mm			
	blanco - white	1878-2G 000		 x50	u. 8414419007000
1880		Contera interior cuadrada 80 mm - Inner square ferrule 80 mm.			
	negro - black	1880-3G 000		 x25	u. 8414419848382
1910		Contera redonda exterior goma Ø 10 mm - Outer round rubber ferrule Ø10 mm.			
	negro - black	1910-3- 001	8414419191037	 x10  4	8414419843073
	negro - black	1910-3G 000		 x25	u. 8414419010710
	negro - black	1910-3P 000	8414419010451	 x14 	8414419809079
1912		Contera redonda exterior goma Ø 12 mm - Outer round rubber ferrule Ø12 mm.			
	negro - black	1912-3- 001	8414419191235	 x10  4	8414419843097
	negro - black	1912-3G 000		 x25	u. 8414419006935
	negro - black	1912-3P 000	8414419010468	 x14 	8414419809086
1914		Contera redonda exterior goma Ø 14 mm - Outer round rubber ferrule Ø14 mm.			
	negro - black	1914-3- 001	8414419191433	 x10  4	8414419843110

MODELO MODEL	COLOR COLOUR	ARTÍCULO ARTICLE	EAN ARTÍCULO EAN ARTICLE	EMBALAJE PACKING	EAN EMBALAJE EAN PACKING
	negro - black	1914-3G	000	 x25	u. 8414419006805
1916		Contera redonda exterior goma Ø 16 mm - Outer round rubber ferrule Ø16 mm.			
	negro - black	1916-3-	001	 x10	 4 8414419843134
	negro - black	1916-3G	000	 x25	u. 8414419006812
	negro - black	1916-3P	000	 x14	 16 8414419809062
1917		Contera redonda exterior goma Ø 17 mm - Outer round rubber ferrule Ø17 mm.			
	negro - black	1917-3-	001	 x10	 4 8414419843158
	negro - black	1917-3G	000	 x25	u. 8414419006829
1918		Contera redonda exterior goma Ø 18 mm - Outer round rubber ferrule Ø18 mm.			
	negro - black	1918-3-	001	 x10	 4 8414419843172
	negro - black	1918-3G	000	 x25	u. 8414419010727
	negro - black	1918-3P	000	 x16	 16 8414419809093
1919		Contera redonda exterior goma Ø 19 mm - Outer round rubber ferrule Ø19 mm			
	negro - black	1919-3G	001	 x25	u. 8414419840126
1920		Contera redonda exterior goma Ø 20 mm - Outer round rubber ferrule Ø20 mm.			
	negro - black	1920-3-	001	 x10	 4 8414419843196
	negro - black	1920-3G	000	 x25	u. 8414419010734
	negro - black	1920-3P	000	 x20	 8 8414419809109
1921		Contera redonda exterior goma Ø 21 mm - Outer round rubber ferrule Ø21 mm.			
	negro - black	1921-3G	001	 x25	u. 8414419840133
1922		Contera redonda exterior goma Ø 22 mm - Outer round rubber ferrule Ø22 mm.			
	negro - black	1922-3-	001	 x10	 4 8414419843219
	negro - black	1922-3G	000	 x25	u. 8414419010741
	negro - black	1922-3P	000	 x20	 8 8414419809116
1925		Contera redonda exterior goma Ø 25 mm - Outer round rubber ferrule Ø25 mm.			
	negro - black	1925-3-	001	 x10	 4 8414419843233
	negro - black	1925-3G	000	 x25	u. 8414419006850
	negro - black	1925-3P	000	 x25	 8 8414419809123
1930		Contera redonda exterior goma Ø 30 mm - Outer round rubber ferrule Ø30 mm.			
	negro - black	1930-3-	001	 x9	 4 8414419843257
	negro - black	1930-3G	000	 x25	u. 8414419010758
1935		Contera redonda exterior goma Ø 35 mm - Outer round rubber ferrule Ø35 mm.			

MODELO MODEL	COLOR COLOUR	ARTÍCULO ARTICLE	EAN ARTÍCULO EAN ARTICLE	EMBALAJE PACKING	EAN EMBALAJE EAN PACKING
	negro - black	1935-3- 001	8414419193536	 x9 	8414419843271
	negro - black	1935-3G 000		 x25 	8414419010765
1970	 Cinta magnética adhesiva 19mm x 1m - Adhesive magnetic tape 19mm x 1m				
	negro - black	1970-3- 000	8414419197039	 x12 	8414419842502
1971	 Lámina magnética autoadhesiva 100 x 85 mm. - Self-adhesive magnetic sheet 100 x 85 mm				
	negro - black	1971-3- 000	8414419197138	 x22 	8414419842526
1976	 Cinta adhesiva reforzada 19 mm x 1,5 m. - Reinforced adhesive tape 19 mm x 1,5 m.				
	transparente - transparent	1976-0- 001	8414419197602	 x14 	8414419841512
1977	 Cinta adhesiva reforzada 19 mm x 2,5 m. - Reinforced adhesive tape 19 mm x 2,5 m.				
	transparente - transparent	1977-0- 001	8414419197701	 x12 	8414419841536
1980	 Cinta adhesiva moqueta 50 mm x 5 m - Carpet adhesive tape 50 mm. x 5 m.				
	blanco - white	1980-2- 000	8414419198029	 x48 	8414419801233
1981	 Cinta adhesiva moqueta 50 mm x25 m - Carpet adhesive tape 50 mm. x 25 m.				
	blanco - white	1981-2- 000	8414419198128	 x24 	8414419801240
1983	 Cinta americana 25 mm x 10 m - Cloth adhesive tape 25 mm. x 10 m.				
	blanco - white	1983-2- 000	8414419198326	 x10 	8414419801264
	negro - black	1983-3- 000	8414419198333	 x10 	8414419801271
	gris - grey	1983-7- 000	8414419198371	 x10 	8414419801288
1984	 Cinta americana 50 mm x 10 m - Cloth adhesive tape 50 mm. x 10 m.				
	blanco - white	1984-2- 000	8414419198425	 x4 	8414419817425
	negro - black	1984-3- 000	8414419198432	 x4 	8414419817432
	gris - grey	1984-7- 000	8414419198470	 x4 	8414419817449
1986	 Cinta aluminio 50 mm x 5 m - Aluminium adhesive tape 50 mm. x 5 m.				
	aluminio - aluminium	1986-1- 000	8414419198616	 x6 	8414419810426
	blanco - white	1986-2- 000	8414419198623	 x6 	8414419810419
	negro - black	1986-3- 000	8414419198630	 x6 	8414419844759
1987	 Cinta aluminio 50 mm x 10 m - Aluminium adhesive tape 50 mm. x 10 m.				
	aluminio - aluminium	1987-1- 000	8414419198715	 x4 	8414419810433
	blanco - white	1987-2- 000	8414419198722	 x4 	8414419810440
1988	 Cinta antideslizante 25 mm x 15 m. - Non-slip adhesive tape 25 mm. x 15 m.				
	transparente - transparent	1988-0- 001	8414419198807	 x8 	8414419825468
	negro - black	1988-3- 001	8414419198838	 x8 	8414419825475

MODELO MODEL	COLOR COLOUR	ARTÍCULO ARTICLE	EAN ARTÍCULO EAN ARTICLE	EMBALAJE PACKING	EAN EMBALAJE EAN PACKING
	negro-amarillo - black-yellow	1988-9- 001	8414419198890	 x8	 1 8414419825482
1989	 Cinta antideslizante 25 mm x 5 m - Non-slip adhesive tape 25 mm. x 5 m.				
	transparente - transparent	1989-0- 000	8414419198906	 x10	 1 8414419801370
	negro - black	1989-3- 003	8414419198937	 x12	 1 8414419838253
	negro-amarillo - black-yellow	1989-9- 000	8414419198999	 x10	 1 8414419801394
1990	 Cinta antideslizante 50 mm x 5 m - Non-slip adhesive tape 50 mm. x 5 m.				
	negro - black	1990-3- 001	8414419199033	 x10	 1 8414419801400
1991	 Cinta anti-resbalones para suelos mojados 25mm x 5m - Non-slip adhesive tape for wet floor 25mm x 5 m.				
	transparente - transparent	1991-0- 000	8414419199101	 x6	 1 8414419810402
1992	 Discos adhesivos antiresbalones Ø 38 mm. - Non-slip adhesive discs Ø 38 mm				
	transparente - transparent	1992-0- 000	8414419199200	 x10	 16 8414419826304
1994	 Masilla adhesiva removible - Adhesive removable putty 50 gr.				
	azul - blue	1994-8- 000	8414419199484	 x14	 1 8414419809277
1995	 Cinta autosoldable 19 mm x 3 m - Self-bonding tape 19 mm. x 3 m.				
	blanco - white	1995-2- 000	8414419199521	 x12	 1 8414419809826
	negro - black	1995-3- 000	8414419199538	 x12	 1 8414419809833
1996	 Cinta adhesiva 2 caras para exteriores 19 mm x 1,5 m - Outdoors double sided adhesive tape 19 mm x 1,5 m				
	negro - black	1996-3- 000	8414419199637	 x14	 1 8414419842595
1997	 Cinta adhesiva 2 caras 19 mm x 1,5 m. - Double sided adhesive tape 19 mm. x 1,5 m.				
	transparente - transparent	1997-2- 001	8414419199729	 x14	 1 8414419809963
1998	 Cinta adhesiva 2 caras 19 mm x 2,5 m. - Double sided adhesive tape 19 mm. x 2,5 m.				
	transparente - transparent	1998-2- 002	8414419199828	 x12	 1 8414419843554
2000	 Cinta adhesiva 2 caras 15 mm x 1,5 m - Double sided adhesive tape 15 mm. x 1,5 m.				
	blanco - white	2000-2- 000	8414419200029	 x14	 1 8414419810365
2001	 Cinta adhesiva 2 caras 15 mm x 0,75 m - Double sided adhesive tape 15 mm. x 0,75 m.				
	blanco - white	2001-2- 000	8414419200128	 x16	 1 8414419810372
2002	 Plaquetas cinta adhesiva dos caras 30 x 13 mm - Double sided adhesive strips 30 x 13 mm.				
	blanco - white	2002-2- 000	8414419200227	 x22	 15 8414419812550
2005	 Cinta adhesiva 2 caras 15 mm x 2,5 m - Double sided adhesive tape 15 mm. x 2,5 m.				
	blanco - white	2005-2- 000	8414419200524	 x20	 1 8414419802704

MODELO MODEL	COLOR COLOUR	ARTÍCULO ARTICLE	EAN ARTÍCULO EAN ARTICLE	EMBALAJE PACKING	EAN EMBALAJE EAN PACKING	
2006		Cinta adhesiva 2 caras 25 mm x 2,5 m - Double sided adhesive tape 25 mm. x 2,5 m.				
	blanco - white	2006-2- 000	8414419200623	 x20 	8414419802711	
2007		Cinta adhesiva 2 caras 15 mm x 15 m. - Double sided adhesive tape 15 mm. x 15 m.				
	blanco - white	2007-2- 001	8414419200722	 x12 	8414419825444	
2008		Cinta adhesiva 2 caras 25 mm x 15 m. - Double sided adhesive tape 25 mm. x 15 m.				
	blanco - white	2008-2- 001	8414419200821	 x8 	8414419825451	
2009		Cinta de cierre de gancho y bucle autoadherente 9 mm x 3 m - Self-adhesive hook-and-loop fastener tape, 9 mm x 3 m.				
	negro - black	2009-3- 001	8414419200937	 x12 	8414419854406	
	verde - green	2009-5- 000	8414419200951	 x22 	8414419802766	
2010		Colgador adhesivo metal-plástico grande - Adhesive hook				
	blanco - white	2010-2- 000	8414419201026	 x10 	8414419802773	
2011		Colgador adhesivo de acero inoxidable - Stainless steel adhesive hook				
	acero - steel	2011-1- 001	8414419201118	 x16 	8414419821149	
2013		Colgador adhesivo base de acero inoxidable - Adhesive hook with stainless steel base				
	cromado - chrome	2013-1- 000	8414419201316	 x10 	8414419802803	
	blanco - white	2013-2- 000	8414419201323	 x10 	8414419802810	
	negro - black	2013-3- 000	8414419201330	 x10 	8414419802827	
	cromado mate - matt chrome	2013-7- 000	8414419012868	 x10 	8414419830257	
	madera - wood	2013-9- 000	8414419201392	 x10 	8414419802834	
2018		Colgador adhesivo - Adhesive hook				
	acero - steel	2018-1- 001	8414419201811	 x12 	8414419821262	
2019		Colgador adhesivo - Adhesive hook				
	acero - steel	2019-1- 001	8414419201910	 x16 	8414419821156	
	blanco - white	2019-2- 001	8414419201927	 x16 	8414419821163	
2021		Tope de puerta adhesivo con efecto amortiguador - Adhesive door stop with shock-absorption effect				
	cromado - chrome	2021-1- 000	8414419202115	 x10 	8414419812154	
	blanco - white	2021-2- 000	8414419202122	 x10 	8414419812161	
	marrón - brown	2021-4- 000	8414419202146	 x10 	8414419812178	
	beige - beige	2021-6- 000	8414419202160	 x10 	8414419812185	
	cromo mate - matt chrome	2021-7- 000	8414419202177	 x10 	8414419812192	
2023		Tope de puerta adhesivo - Adhesive door stop				
	blanco - white	2023-2- 000	8414419202320	 x10 	8414419811652	

MODELO MODEL	COLOR COLOUR	ARTÍCULO ARTICLE	EAN ARTÍCULO EAN ARTICLE	EMBALAJE PACKING	EAN EMBALAJE EAN PACKING
	blanco - white	2023-2- 001	8414419202320	x10	8414419811652
	blanco - white	2023-2P 003	8414419008304	x12	8414419845831
	blanco - white	2023-2P 001	8414419008304	x7	8414419827073
	blanco - white	2023-2P 002	8414419008304	x7	8414419827073
	negro - black	2023-3- 000	8414419202337	x10	8414419811669
	marrón - brown	2023-4- 001	8414419202344	x10	8414419811676
	marrón - brown	2023-4P 002	8414419008311	x7	8414419827080
	beige - beige	2023-6- 001	8414419202368	x10	8414419811683
	beige - beige	2023-6P 002	8414419008328	x7	8414419827097
	gris - grey	2023-7- 000	8414419202375	x10	8414419811690
	gris - grey	2023-7P 002	8414419011724	x12	8414419845879
	parquet beige - light wood	2023-8- 000	8414419202382	x10	8414419811706
	parquet beige - light wood	2023-8P 001	8414419011731	x7	8414419827110
	parquet marrón - dark wood	2023-9- 000	8414419202399	x10	8414419811713
	parquet marrón - dark wood	2023-9P 001	8414419011748	x7	8414419827127

2025 **Tope y retenedor de puerta adhesivo - Adhesive door stop and door retainer**

























































	blanco - white	2025-2- 000	8414419202528	x10	8414419812208
	marrón - brown	2025-4- 000	8414419202542	x10	8414419812215































































2026 **Retenedor pinza adhesivo de puerta - Adhesive door retainer**



























































	blanco - white	2026-2- 000	8414419202627	x10	8414419818064
	marrón - brown	2026-4- 000	8414419202641	x10	8414419818071

























































2027 **Tope de puerta adhesivo silencioso - Silent adhesive door stop**













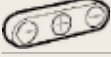





	cromado - chrome	2027-1- 000	8414419202719	x12	8414419812222
	cromado - chrome	2027-1P 000	8414419009400	x5	8414419809376
	blanco - white	2027-2- 000	8414419202726	x12	8414419812239
	blanco - white	2027-2P 000	8414419009752	x5	8414419810310
	dorado - golden	2027-3- 000	8414419202733	x12	8414419812246
	dorado - golden	2027-3P 000	8414419009769	x5	8414419810716
	marrón - brown	2027-4- 000	8414419202740	x12	8414419812253
	beige - beige	2027-6- 000	8414419202764	x12	8414419812260
	cromo mate - matt chrome	2027-7- 000	8414419202771	x12	8414419812277
	cromo mate - matt chrome	2027-7P 000	8414419009417	x5	8414419809383
	negro - black	2027-8- 000	8414419202788	x12	8414419812284
	madera - wood	2027-9- 000	8414419202795	x12	8414419812291
	madera - wood	2027-9P 000	8414419009424	x5	8414419809390

























































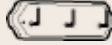

MODELO MODEL	COLOR COLOUR	ARTÍCULO ARTICLE	EAN ARTÍCULO EAN ARTICLE	EMBALAJE PACKING	EAN EMBALAJE EAN PACKING
2029		Tope de puerta adhesivo semiesferico - Semispherical adhesive door stop			
	blanco - white	2029-2- 000	8414419202924	 x12 	8414419816824
	marrón - brown	2029-4- 000	8414419202948	 x12 	8414419816848
	beige - beige	2029-6- 000	8414419202962	 x12 	8414419816855
2030		Descapsulador mural adhesivo - Adhesive bottle opener			
	blanco - white	2030-2- 001	8414419203020	 x6 	8414419829657
2031		Tope de puerta adhesivo base blanca - Adhesive door stop			
	blanco - white	2031-2- 000	8414419203129	 x10 	8414419818088
2032		Tope de puerta madera adhesivo - Wooden adhesive door stop			
	sapelly - sapelly	2032-0- 001	8414419203204	 x10 	8414419812307
	roble - oak	2032-3- 002	8414419203235	 x10 	8414419812314
	roble - oak	2032-3P 003	8414419009363	 x8 	8414419845916
	haya - beech	2032-8- 003	8414419203280	 x10 	8414419812321
	haya - beech	2032-8P 002	8414419007925	 x8 	8414419845930
2033		Tope de puerta adhesivo flexible - Flexible adhesive door stop			
	transparente - transparent	2033-0- 000	8414419203303	 x10 	8414419809628
	transparente - transparent	2033-0P 002	8414419011755	 x9 	8414419845954
	blanco - white	2033-2- 000	8414419203327	 x10 	8414419808270
	blanco - white	2033-2P 001	8414419009776	 x5 	8414419827219
	negro - black	2033-3- 000	8414419203334	 x10 	8414419808287
	marrón - brown	2033-4- 000	8414419203341	 x10 	8414419808294
	beige - beige	2033-6- 000	8414419203365	 x10 	8414419808300
	beige - beige	2033-6P 001	8414419009431	 x5 	8414419827226
	gris metalizado - silver grey	2033-7- 000	8414419203372	 x10 	8414419808317
2034		Retenedor de puerta adhesivo magnético - Adhesive magnetic door retainer			
	blanco - white	2034-2- 000	8414419203426	 x10 	8414419812338
	dorado - golden	2034-3- 000	8414419203433	 x10 	8414419812345
	marrón - brown	2034-4- 000	8414419203440	 x10 	8414419812352
	beige - beige	2034-6- 000	8414419203464	 x10 	8414419812369
	beige - beige	2034-6P 002	8414419011793	 x8 	8414419845978
	chromo mate - matt chrome	2034-7- 000	8414419203471	 x10 	8414419812376
	chromo mate - matt chrome	2034-7P 002	8414419011809	 x8 	8414419845992
	chromo mate - matt chrome	2034-7P 001	8414419011809	 x5 	8414419827257

























MODELO MODEL	COLOR COLOUR	ARTÍCULO ARTICLE	EAN ARTÍCULO EAN ARTICLE	EMBALAJE PACKING	EAN EMBALAJE EAN PACKING
2035		Tope retenedor de puerta giratorio adhesivo - Adhesive door stop with revolving retainer			
	transparente - transparent	2035-0- 000	8414419203501	 x10 	8414419812543
	blanco - white	2035-2- 000	8414419203525	 x10 	8414419811720
	blanco - white	2035-2P 002	8414419009783	 x9 	8414419846012
	negro - black	2035-3- 000	8414419203532	 x10 	8414419811737
	marrón - brown	2035-4- 000	8414419203549	 x10 	8414419811744
	beige - beige	2035-6- 000	8414419203563	 x10 	8414419811751
	beige - beige	2035-6P 002	8414419009455	 x9 	8414419846036
	gris-metalizado - silver grey	2035-7- 000	8414419203570	 x10 	8414419812383
2036		Retenedor puerta de madera magnético adhesivo - Adhesive wooden magnetic door retainer			
	sapelly - sapelly	2036-0- 001	8414419203600	 x10 	8414419812390
	roble - oak	2036-3- 001	8414419203631	 x10 	8414419812406
	roble - oak	2036-3P 001	8414419011762	 x5 	8414419827288
	haya - beech	2036-8- 001	8414419203686	 x10 	8414419812413
2037		Tope de puerta adhesivo y retenedor magnético - Adhesive door stop and magnetic retainer			
	cromado - chrome	2037-1- 000	8414419203716	 x10 	8414419808478
	blanco - white	2037-2- 000	8414419203723	 x10 	8414419808485
	dorado - golden	2037-3- 000	8414419203730	 x10 	8414419808492
	marrón - brown	2037-4- 000	8414419203747	 x10 	8414419808508
	beige - beige	2037-6- 000	8414419203761	 x10 	8414419808515
	cromo mate - matt chrome	2037-7- 000	8414419203778	 x10 	8414419808522
	negro mate - matt black	2037-8- 000	8414419203785	 x10 	8414419845695
2038		Tope puerta de madera adhesivo - Wooden adhesive door stop			
	haya - beech	2038-8- 000	8414419203884	 x10 	8414419812420
	haya - beech	2038-8P 000	8414419009325	 x5 	8414419810389
2039		Tope adhesivo de madera - Wooden adhesive door stop			
	sapelly - sapelly	2039-0- 001	8414419203907	 x10 	8414419812437
	sapelly - sapelly	2039-0P 002	8414419009370	 x10 	8414419846050
	roble - oak	2039-3- 003	8414419203938	 x10 	8414419812444
	roble - oak	2039-3P 003	8414419009387	 x10 	8414419846074
	haya - beech	2039-8- 001	8414419203983	 x10 	8414419812451
	haya - beech	2039-8P 002	8414419009394	 x10 	8414419846098
2040		Colgador adhesivo - Adhesive hook			
	acero - steel	2040-1- 000	8414419204010	 x16 	8414419820685































































MODELO MODEL	COLOR COLOUR	ARTÍCULO ARTICLE	EAN ARTÍCULO EAN ARTICLE	EMBALAJE PACKING	EAN EMBALAJE EAN PACKING
	blanco - white	2040-2- 000	8414419204027	 x16  2	8414419820692
	madera - wood	2040-9- 000	8414419204096	 x16  2	8414419820708
2042	 Colgador adhesivo visillos - Adhesive hook for net curtains				
	transparente - transparent	2042-0- 000	8414419012882	 x20  4	8414419830349
	cromado - chrome	2042-1- 000	8414419204218	 x20  4	8414419802988
	blanco - white	2042-2- 000	8414419204225	 x20  4	8414419802995
	dorado - golden	2042-3- 000	8414419204232	 x20  4	8414419803008
	marrón - brown	2042-4- 000	8414419204249	 x20  4	8414419803015
	cromado mate - matt chrome	2042-7- 000	8414419204270	 x20  4	8414419803022
2044	 Colgador adhesivo metal-plástico grande - Adhesive hook				
	blanco - white	2044-2- 000	8414419204423	 x10  1	8414419819894
2045	 Colgador adhesivo base de acero inoxidable - Adhesive hook with stainless steel base				
	cromado - chrome	2045-1- 000	8414419204515	 x10  1	8414419819917
	blanco - white	2045-2- 000	8414419204522	 x10  1	8414419819924
	negro - black	2045-3- 000	8414419204539	 x10  1	8414419819931
	cromado mate - matt chrome	2045-7- 000	8414419012875	 x10  1	8414419830264
	madera - wood	2045-9- 000	8414419204591	 x10  1	8414419819948
2050	 Tope de puerta semiesférico con adhesivo extrafuerte - Extra strong adhesive semispherical door stop				
	transparente - transparent	2050-2- 000	8414419205024	 x10  1	8414419812468
	transparente - transparent	2050-2P 001	8414419011786	 x10  4	8414419827745
2054	 Tope de puerta silencioso con adhesivo extrafuerte - Extra strong adhesive silent door stop				
	transparente - transparent	2054-0- 000	8414419011335	 x10  1	8414419820036
2055	 Colgador escobas adhesivo de acero templado - Hardened steel adhesive broom hook				
	cromado mate - matt chrome	2055-7H C01	8414419106253	 x50  u.	8414419814769
	negro mate - matt black	2055-3H C01	8414419017092	 x50  u.	8414419854352
	blanco - white	2055-2H C01	8414419001565	 x50  u.	8414419809260
	blanco - white	2055-2- 000	8414419008267	 x8  2	8414419815919
	blanco - white	2055-2H 000	8414419001565	 x50  u.	8414419824393
	negro mate - matt black	2055-3- 000	8414419017085	 x8  2	8414419854338
	negro mate - matt black	2055-3H 000	8414419017092	 x50  u.	8414419854376
	cromado mate - matt chrome	2055-7- 000	8414419008564	 x8  2	8414419815926
	cromado mate - matt chrome	2055-7H 000	8414419106253	 x50  u.	8414419824409























































MODELO MODEL	COLOR COLOUR	ARTÍCULO ARTICLE	EAN ARTÍCULO EAN ARTICLE	EMBALAJE PACKING	EAN EMBALAJE EAN PACKING
2056		Colgador escobas carenado adhesivo - Adhesive broom hook with cover			
	blanco - white	2056-2- 000	8414419205628	 x6 	8414419820586
	negro mate - matt black	2056-3- 000	8414419205635	 x6 	8414419848481
2058		Tope retenedor giratorio metálico - Revolving metallic door stop retainer			
	blanco - white	2058-2- 000	8414419010932	 x10 	8414419824645
	blanco - white	2058-2G 000	8414419010963	 x20 	8414419824751
	marrón - brown	2058-4- 000	8414419010949	 x10 	8414419824669
	marrón - brown	2058-4G 000	8414419010970	 x20 	8414419824775
	beige - beige	2058-6- 000	8414419010956	 x10 	8414419824683
	beige - beige	2058-6G 000	8414419010987	 x20 	8414419824799
2061		Colgador adhesivo - Adhesive hook			
	blanco - white	2061-3- 000	8414419206137	 x16 	8414419820425
	madera - wood	2061-8- 000	8414419206182	 x16 	8414419820432
2063		Colgador adhesivo - Adhesive hook			
	blanco - white	2063-3- 000	8414419206335	 x16 	8414419820364
	madera - wood	2063-8- 000	8414419206380	 x16 	8414419820371
2069		Colgador adhesivo mini - Adhesive mini hook			
	blanco - white	2069-3- 000	8414419206939	 x20 	8414419803275
	madera - wood	2069-8- 000	8414419206984	 x20 	8414419803282
2071		Colgador adhesivo mini - Adhesive mini hook			
	blanco - white	2071-3- 000	8414419207134	 x20 	8414419803312
	madera - wood	2071-8- 000	8414419207189	 x20 	8414419803329
2075		Colgador adhesivo - Adhesive hook			
	transparente - transparent	2075-0- 000	8414419207509	 x16 	8414419838840
	blanco - white	2075-2- 000	8414419207523	 x16 	8414419821231
	madera - wood	2075-9- 000	8414419207592	 x16 	8414419821255
2077		Colgador adhesivo - Adhesive hook			
	acero - steel	2077-1- 000	8414419207714	 x12 	8414419820678
2078		Colgador adhesivo con base metálica - Adhesive hook with stainless steel base			
	arce - maple	2078-A- 001	8414419013070	 x8 	8414419831551
	blanco - white	2078-B- 001	8414419013063	 x8 	8414419831629
	wengué - wengue	2078-W- 001	8414419013087	 x8 	8414419831544
	blanco - white	2078-2- 000	8414419013056	 x8 	8414419831575

























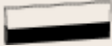







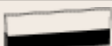







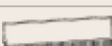







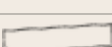







MODELO MODEL	COLOR COLOUR	ARTÍCULO ARTICLE	EAN ARTÍCULO EAN ARTICLE	EMBALAJE PACKING	EAN EMBALAJE EAN PACKING
	Cromo mate - matt chrome	2078-7- 000	8414419207875	 x8 	8414419831568
	Madera - wood	2078-9- 000	8414419207899	 x8 	8414419831582
2080	 Colgador adhesivo - Adhesive hook				
	blanco - white	2080-2- 000	8414419208025	 x16 	8414419820289
	negro - black	2080-3- 000	8414419208032	 x16 	8414419820296
	madera - wood	2080-8- 000	8414419208087	 x16 	8414419820333
2083	 Colgador paños cocina adhesivo - Triple adhesive cloth hook				
	blanco - white	2083-2- 000	8414419208322	 x10 	8414419803527
	cromo mate - matt chrome	2083-7- 000	8414419208377	 x10 	8414419803534
2084	 Colgador paños cocina adhesivo - Adhesive cloth hook				
	blanco - white	2084-2- 000	8414419008755	 x10 	8414419816206
2085	 Colgador adhesivo - Adhesive hook				
	blanco - white	2085-2- 000	8414419008762	 x8 	8414419818200
2086	 Colgador adhesivo arco - Adhesive arch hook				
	beige satinado - satin beige	2086-B- 000	8414419001541	 x6 	8414419815988
	marrón satinado - satin brown	2086-M- 000	8414419001558	 x6 	8414419815995
	negro - black	2086-N- 000	8414419010581	 x6 	8414419818712
	blanco - white	2086-2- 000	8414419008663	 x6 	8414419815964
	cromado - chrome	2086-5- 000	8414419008571	 x6 	8414419815834
	cromo mate - matt chrome	2086-8- 000	8414419008595	 x6 	8414419815858
2088	 Colgador adhesivo "J" - Adhesive "J" hook				
	beige satinado - satin beige	2088-B- 000	8414419007215	 x6 	8414419816015
	marrón satinado - satin brown	2088-M- 000	8414419008083	 x6 	8414419816022
	negro - black	2088-N- 000	8414419010857	 x6 	8414419818767
	metalizado plata - silver metallized	2088-1- 000	8414419008601	 x6 	8414419815865
	blanco - white	2088-2- 000	8414419008618	 x6 	8414419815872
	cromo mate - matt chrome	2088-8- 000	8414419008649	 x6 	8414419815902
2089	 Colgador paño cocina adhesivo - Adhesive cloth hook				
	blanco - white	2089-2- 000	8414419208926	 x12 	8414419821217
	cromo mate - matt chrome	2089-7- 000	8414419208971	 x12 	8414419821224
2090	 Tope multi-uso adhesivo - Adhesive buffer				
	blanco - white	2090-2- 000	8414419209022	 x20 	8414419826946
	marrón - brown	2090-4- 000	8414419209046	 x20 	8414419826953



























































MODELO MODEL	COLOR COLOUR	ARTÍCULO ARTICLE	EAN ARTÍCULO EAN ARTICLE	EMBALAJE PACKING	EAN EMBALAJE EAN PACKING
2091		Tope multi-uso adhesivo - Adhesive buffer			
	blanco - white	2091-2- 000	8414419209121	 x20  18	8414419826984
	marrón - brown	2091-4- 000	8414419209145	 x20  18	8414419826991
2093		Tope de puerta adhesivo cilindro - Adhesive door stop cylinder			
	transparente - transparent	2093-0- 000	8414419012370	 x10  2	8414419826243
	transparente - transparent	2093-0P 000	8414419012387	 x10  6	8414419826267
2095		Tope y retenedor pinza adhesivos para puerta - Adhesive door stop and clamp retainer			
transparente - transparent	2095-0- 000	8414419012394	 x10  1	8414419826281	
2098		Tope cilíndrico adhesivo extra fuerte - Extra strong adhesive cylindrical doorstop			
	blanco - white	2098-B- 000	8414419016026	 x10  1	8414419843868
	chromo mate - matt chrome	2098-C- 000	8414419016033	 x10  1	8414419843851
	transparente - transparent	2098-0- 000	8414419013025	 x10  1	8414419831520
	olivo mediterráneo - mediterranean olive tree	2098-1- 000	8414419209817	 x10  1	8414419843738
	arce nórdico - nordic maple	2098-2- 000	8414419209824	 x10  1	8414419843752
	fresno calcáreo - limestone ash tree	2098-3- 000	8414419209831	 x10  1	8414419843776
	nogal americano - hickory	2098-4- 000	8414419209848	 x10  1	8414419843790
	roble atlántico - atlantic oak	2098-5- 000	8414419209855	 x10  1	8414419843813
	wengué - wengue	2098-6- 000	8414419209862	 x10  1	8414419843837
2099		Tope de puerta metálico con adhesivo - Adhesive metallic doorstop			
	cromado - chrome	2099-1- 000	8414419209916	 x10  1	8414419831209
	cromado - chrome	2099-1U 000	8414419009127	 x10  1	8414419831285
	blanco - white	2099-2- 000	8414419209923	 x10  1	8414419831223
	blanco - white	2099-2U 000	8414419010390	 x10  1	8414419831308
	dorado - golden	2099-6- 000	8414419209961	 x10  1	8414419831247
	dorado - golden	2099-6U 000	8414419012967	 x10  1	8414419831322
	chromo mate - matt chrome	2099-7- 000	8414419209978	 x10  1	8414419831261
chromo mate - matt chrome	2099-7U 000	8414419012974	 x10  1	8414419831346	
2103		Colgador adhesivo de madera con 3 ganchos - Three hook adhesive wooden rack			
	sapelly - sapelly	2103-0- 000	8414419210301	 x10  1	8414419803787
	haya - beech	2103-8- 000	8414419210387	 x10  1	8414419803794
2106		Colgador adhesivo con gancho móvil - Adhesive mobile hook			
	transparente - transparent	2106-0- 000	8414419210608	 x10  2	8414419839540
	blanco - white	2106-2- 000	8414419210622	 x10  2	8414419840935

























































MODELO MODEL	COLOR COLOUR	ARTÍCULO ARTICLE	EAN ARTÍCULO EAN ARTICLE	EMBALAJE PACKING	EAN EMBALAJE EAN PACKING
	cromado mate - matt chrome	2106-7- 000	8414419210677	 x10  2	8414419840959
2107	 Mini ganchos adhesivos - Adhesive mini hooks				
	transparente - transparent	2107-0- 000	8414419210707	 x12  12	8414419838932
	transparente - transparent	2107-0- 001	8414419210707	 x48  12	8414419841161
	caja expositora - Counter display box				
2110	 Burlete silicona adhesivo 6 m. - Self-adhesive silicone weatherstrip 6m.				
	transparente - transparent	2110-0- 000	8414419211001	 x12  1	8414419811041
	marrón - brown	2110-4- 000	8414419211049	 x12  1	8414419803831
2115	 Burlete de caucho adhesivo "K" 6 m. - Self-adhesive rubber weatherstrip "K" 6m.				
	blanco - white	2115-2- 000	8414419211520	 x24  1	8414419803862
	marrón - brown	2115-4- 000	8414419211544	 x24  1	8414419803879
2116	 Burlete de caucho adhesivo "P" 6 m. - Self-adhesive rubber weatherstrip "P" 6m.				
	blanco - white	2116-2- 000	8414419211629	 x24  1	8414419803886
	marrón - brown	2116-4- 000	8414419211643	 x24  1	8414419803893
2119	 Burlete de caucho adhesivo "D" 6 m. - Self-adhesive rubber weatherstrip "D" 6m.				
	blanco - white	2119-2- 000	8414419211926	 x20  1	8414419803930
	marrón - brown	2119-4- 000	8414419211940	 x20  1	8414419803947
2121	 Tapajuntas adhesivo 820 mm - Adhesive coverstrips 820 mm.				
	acero inox. - stainless steel	2121-1- 000	8414419212114	 x20  1	8414419803978
	acero inox. - stainless steel	2121-1- 010	8414419212114	 x10  1	8414419811072
	latón - brass	2121-6- 000	8414419212169	 x20  1	8414419803985
	latón - brass	2121-6- 010	8414419212169	 x10  1	8414419811089
2122	 Tapajuntas adhesivo 985 mm - Adhesive coverstrips 985 mm.				
	acero inox. - stainless steel	2122-1- 000	8414419212213	 x20  1	8414419803992
	latón - brass	2122-6- 000	8414419212268	 x20  1	8414419804005
2124	 Tapajuntas adhesivo 820 mm - Adhesive coverstrips 820 mm.				
	acero inox. - stainless steel	2124-1- 000	8414419212411	 x20  1	8414419804050
	acero inox. - stainless steel	2124-1- 010	8414419212411	 x10  1	8414419811096
	roble ibérico - iberian oak	2124-3- 000	8414419212435	 x20  1	8414419804067
	roble ibérico - iberian oak	2124-3- 010	8414419212435	 x10  1	8414419811102
	latón - brass	2124-6- 000	8414419212466	 x20  1	8414419804074
	latón - brass	2124-6- 010	8414419212466	 x10  1	8414419811119
	sapelly ugandés - ugandan sapelly	2124-8- 000	8414419212480	 x20  1	8414419804081
	sapelly ugandés - ugandan sapelly	2124-8- 010	8414419212480	 x10  1	8414419811126







































MODELO MODEL	COLOR COLOUR	ARTÍCULO ARTICLE	EAN ARTÍCULO EAN ARTICLE	EMBALAJE PACKING	EAN EMBALAJE EAN PACKING
2125		Tapajuntas adhesivo 985 mm - Adhesive coverstrips 985 mm.			
	acero inox. - stainless steel	2125-1- 000	8414419212510	 x20 	8414419804098
	roble polar - polar oak	2125-2- 000	8414419212527	 x10 	8414419854437
	roble ibérico - iberian oak	2125-3- 000	8414419212534	 x20 	8414419804104
	fresno calcáreo - limestone ash tree	2125-4- 000	8414419212541	 x10 	8414419854444
	nogal americano - hickory	2125-5- 000	8414419212558	 x10 	8414419854451
	latón - brass	2125-6- 000	8414419212565	 x20 	8414419804111
	roble atlántico - atlantic oak	2125-7- 000	8414419212572	 x10 	8414419854468
	sapelly ugandés - ugandan sapelly	2125-8- 000	8414419212589	 x20 	8414419804128
2127		Tapajuntas adhesivo 820 mm - Adhesive coverstrips 820 mm.			
	acero inox. - stainless steel	2127-1- 000	8414419212718	 x20 	8414419804173
	acero inox. - stainless steel	2127-1- 010	8414419212718	 x10 	8414419811133
	roble ibérico - iberian oak	2127-3- 000	8414419212732	 x20 	8414419804180
	roble ibérico - iberian oak	2127-3- 010	8414419212732	 x10 	8414419811140
	latón - brass	2127-6- 000	8414419212763	 x20 	8414419804197
	latón - brass	2127-6- 010	8414419212763	 x10 	8414419811157
	sapelly ugandés - ugandan sapelly	2127-8- 000	8414419212787	 x20 	8414419804203
	sapelly ugandés - ugandan sapelly	2127-8- 010	8414419212787	 x10 	8414419811164
2128		Tapajuntas adhesivo 985 mm - Adhesive coverstrips 985 mm.			
	acero inox. - stainless steel	2128-1- 000	8414419212817	 x20 	8414419804210
	roble polar - polar oak	2128-2- 000	8414419212824	 x10 	8414419854475
	roble ibérico - iberian oak	2128-3- 000	8414419212831	 x20 	8414419804227
	fresno calcáreo - limestone ash tree	2128-4- 000	8414419212848	 x10 	8414419854482
	nogal americano - hickory	2128-5- 000	8414419212855	 x10 	8414419854499
	latón - brass	2128-6- 000	8414419212862	 x20 	8414419804234
	roble atlántico - atlantic oak	2128-7- 000	8414419212879	 x10 	8414419854505
	sapelly ugandés - ugandan sapelly	2128-8- 000	8414419212886	 x20 	8414419804241
2130		Tapacables adhesivo 1000 mm - Adhesive cable cover 1000 mm.			
	acero - steel	2130-1- 000	8414419213012	 x20 	8414419804258
2135		Tapajuntas adhesivo 820 mm - Adhesive coverstrips 820 mm.			
	acero inox. - stainless steel	2135-1- 000	8414419213517	 x20 	8414419804319
	roble ibérico - iberian oak	2135-3- 000	8414419213531	 x20 	8414419804326
	latón - brass	2135-6- 000	8414419213562	 x20 	8414419804333
	sapelly ugandés - ugandan sapelly	2135-8- 000	8414419213586	 x20 	8414419804340



























































MODELO MODEL	COLOR COLOUR	ARTÍCULO ARTICLE	EAN ARTÍCULO EAN ARTICLE	EMBALAJE PACKING	EAN EMBALAJE EAN PACKING
2136		Tapajuntas adhesivo 985 mm - Adhesive coverstrips 985 mm.			
	acero inox. - stainless steel	2136-1-000	8414419213616	 x20 	8414419804357
	roble ibérico - iberian oak	2136-3-000	8414419213630	 x20 	8414419804364
	latón - brass	2136-6-000	8414419213661	 x20 	8414419804371
	sapelly ugandés - ugandan sapelly	2136-8-000	8414419213685	 x20 	8414419804388
2138		Tapajuntas adhesivo 820 mm - Adhesive coverstrips 820 mm.			
	acero inox. - stainless steel	2138-1-000	8414419213814	 x20 	8414419804432
	acero inox. - stainless steel	2138-1-010	8414419213814	 x10 	8414419811171
	roble ibérico - iberian oak	2138-3-000	8414419213838	 x20 	8414419804449
	roble ibérico - iberian oak	2138-3-010	8414419213838	 x10 	8414419811188
	latón - brass	2138-6-000	8414419213869	 x20 	8414419804456
	latón - brass	2138-6-010	8414419213869	 x10 	8414419811195
	sapelly ugandés - ugandan sapelly	2138-8-000	8414419213883	 x20 	8414419804463
	sapelly ugandés - ugandan sapelly	2138-8-010	8414419213883	 x10 	8414419811201
2139		Tapajuntas adhesivo 985 mm - Adhesive coverstrips 985 mm.			
	acero inox. - stainless steel	2139-1-000	8414419213913	 x20 	8414419804470
	roble ibérico - iberian oak	2139-3-000	8414419213937	 x20 	8414419804487
	latón - brass	2139-6-000	8414419213968	 x20 	8414419804494
	sapelly ugandés - ugandan sapelly	2139-8-000	8414419213982	 x20 	8414419804500
2140		Plaquitas cinta adhesiva 30 x 13 mm - Adhesive plaques 30mm x 13mm			
	transparente - transparent	2140-0-000	8414419214002	 x22 	8414419838444
2141		Cinta adhesiva 2 caras 19 mm x 5 m - Double sided adhesive tape 19 mm x 5 m			
	transparente - transparent	2141-0-000	8414419214101	 x14 	8414419838468
2142		Cinta adhesiva doble cara water resistant 19 mm x 1,5m - Water resistant double-sided adhesive tape 19 mm x 1,5m			
	blanco - white	2142-2-000	8414419214224	 x14 	8414419838475
2143		Tiras adhesivas de cierre de gancho y bucle 20 mm x 10 cm. - Adhesive hook-and-loop fastener strips 20 mm x 10 cm.			
	blanco - white	2143-2-000	8414419017009	 x12 	8414419849303
	negro - black	2143-3-000	8414419017016	 x12 	8414419849327
2144		Rollo adhesivo de cierre de gancho y bucle 20 mm x 1,5 m. - Adhesive hook-and-loop fastener roll, 20 mm x 1.5 m.			
	blanco - white	2144-2-000	8414419017023	 x10 	8414419849341
	negro - black	2144-3-000	8414419017030	 x10 	8414419849365
2145		Rollo adhesivo térmico de cierre de gancho y bucle 20 mm x 1,5 m. - Heat-activated adhesive hook-and-loop fastener roll 20 mm x 1.5 m.			





































MODELO MODEL	COLOR COLOUR	ARTÍCULO ARTICLE	EAN ARTÍCULO EAN ARTICLE	EMBALAJE PACKING	EAN EMBALAJE EAN PACKING
	blanco - white	2145-2- 000	8414419017047	 x10	 1 8414419849389
	negro - black	2145-3- 000	8414419017054	 x10	 1 8414419849402
2146		Discos adhesivos de cierre de gancho y bucle Ø 20 mm. - Adhesive hook-and-loop fastener discs, Ø 20 mm.			
	blanco - white	2146-2- 000	8414419017061	 x12	 20 8414419849426
	negro - black	2146-3- 000	8414419017078	 x12	 20 8414419849440
2150		Burlete bajo puerta adhesivo con cepillo 900 mm - Adhesive door brush strip 900 mm.			
	blanco - white	2150-2- 000	8414419215023	 x10	 1 8414419818958
	marrón - brown	2150-4- 000	8414419215047	 x10	 1 8414419822955
2154		Burlete bajo puerta adhesivo de PVC 820 mm - Adhesive door seal strip with flexible PVC flap 820 mm.			
	transparente - transparent	2154-0- 000	8414419215405	 x10	 1 8414419801622
	blanco - white	2154-2- 000	8414419215429	 x10	 1 8414419823099
	madera clara - light wood	2154-8- 000	8414419215481	 x10	 1 8414419823112
	madera oscura - dark wood	2154-9- 000	8414419215498	 x10	 1 8414419823136
2155		Burlete bajo puerta adhesivo de PVC 1000 mm - Adhesive door seal strip with flexible PVC flap 1000 mm.			
	transparente - transparent	2155-0- 000	8414419215504	 x10	 1 8414419830707
	blanco - white	2155-2- 000	8414419215528	 x10	 1 8414419823174
	madera clara - light wood	2155-8- 000	8414419215580	 x10	 1 8414419823198
	madera oscura - dark wood	2155-9- 000	8414419215597	 x10	 1 8414419823150
2156		Burlete bajo puerta adhesivo con cepillo 820 mm - Adhesive door brush strip 820 mm.			
	transparente - transparent	2156-0- 000	8414419215603	 x10	 1 8414419823211
	blanco - white	2156-2- 000	8414419011458	 x10	 1 8414419823235
	madera clara - light wood	2156-8- 000	8414419011465	 x10	 1 8414419823259
	madera oscura - dark wood	2156-9- 000	8414419011472	 x10	 1 8414419823273
2157		Burlete bajo puerta adhesivo con cepillo 1000 mm - Adhesive door brush strip 1000 mm.			
	transparente - transparent	2157-0- 000	8414419215702	 x10	 1 8414419823303
	blanco - white	2157-2- 000	8414419011489	 x10	 1 8414419823327
	madera clara - light wood	2157-8- 000	8414419011496	 x10	 1 8414419823341
	madera oscura - dark wood	2157-9- 000	8414419011502	 x10	 1 8414419823365
2170		Colgador adhesivo circular - Adhesive hook			
	surtido - assortment	2170-0- 000	incluye surtido de vegetal - mesa - cocina - universo - vegetable, table, kitchen, universe assortment	 x16	 2 8414419825215
	transparente - transparent	2170-1- 000	8414419015036	 x16	 2 8414419838857
	blanco - white	2170-2- 000	8414419011885	 x16	 2 8414419825369
	vegetal - vegetable	2170-3- 000	8414419012035	 x16	 2 8414419825130

























MODELO MODEL	COLOR COLOUR	ARTÍCULO ARTICLE	EAN ARTÍCULO EAN ARTICLE	EMBALAJE PACKING	EAN EMBALAJE EAN PACKING
	mesa - table	2170-4- 000	8414419012042	 x16  2	8414419825154
	cocina - kitchen	2170-5- 000	8414419012059	 x16  2	8414419825178
	universo - universe	2170-6- 000	8414419012066	 x16  2	8414419825192
	cromado mate - matt chrome	2170-7- 000	8414419011892	 x16  2	8414419825383
2176	 Colgador adhesivo de acero inoxidable - Stainless steel adhesive hook				
	acero - steel	2176-1- 000	8414419217614	 x12  2	8414419835009
	blanco - white	2176-2- 000	8414419217621	 x12  2	8414419849730
	negro mate - matt black	2176-3- 000	8414419217638	 x12  2	8414419849754
2179	 Colgador adhesivo - Adhesive hook				
	blanco - white	2179-2- 000	8414419217928	 x10  4	8414419820715
	madera - wood	2179-6- 000	8414419217966	 x10  4	8414419820722
2180	 Colgador adhesivo infantil - Infantile adhesive hook				
	surtido - assortment incluye surtido de naranja - verde - azul - amarillo- rosa - Colours included orange, green, blue, yellow, pink	2180-0- 000		 x10  1	8414419824621
	naranja - orange	2180-4- 000	8414419218048	 x6  1	8414419820548
	verde - green	2180-5- 000	8414419218055	 x6  1	8414419820555
	azul - blue	2180-7- 000	8414419218079	 x6  1	8414419820562
	rosa - pink	2180-8- 000	8414419010925	 x6  1	8414419824614
	amarillo - yellow	2180-9- 000	8414419218093	 x6  1	8414419820579
2190	 Colgador "cinta" water resistant - Water resistant "Ribbon" adhesive hook				
	blanco - white	2190-2- 000	8414419219021	 x8  1	8414419837843
	negro mate - matt black	2190-3- 000	8414419219038	 x8  1	8414419845633
	cromo mate - matt chrome	2190-7- 000	8414419219076	 x8  1	8414419837867
2191	 Colgador "rama" water resistant - Water resistant "Branch" adhesive hook				
	blanco - white	2191-2- 000	8414419219120	 x12  1	8414419837881
	negro mate - matt black	2191-3- 000	8414419219137	 x12  1	8414419846265
	cromo mate - matt chrome	2191-7- 000	8414419219175	 x12  1	8414419837904
2192	 Colgador "rama doble" water resistant - Water resistant "Double branch" adhesive hook				
	blanco - white	2192-2- 000	8414419219229	 x8  1	8414419837928
	negro mate - matt black	2192-3- 000	8414419219236	 x8  1	8414419845657
	cromo mate - matt chrome	2192-7- 000	8414419219274	 x8  1	8414419837942
2193	 Colgador "gota" water resistant - Water resistant "Drop" adhesive hook				
	blanco - white	2193-2- 000	8414419219328	 x12  1	8414419837966
	negro mate - matt black	2193-3- 000	8414419219335	 x12  1	8414419846289





































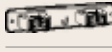



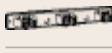











MODELO MODEL	COLOR COLOUR	ARTÍCULO ARTICLE	EAN ARTÍCULO EAN ARTICLE	EMBALAJE PACKING	EAN EMBALAJE EAN PACKING
	chromo mate - matt chrome	2193-7- 000	8414419219373	 x12	 8414419837980
2200	 Cablefix adhesivo 5,5 x 5 mm - Adhesive Cablefix 5,5 x 5 mm.				
	blanco - white	2200-2- 003	8414419017184	 x20	 8414419849471
	marrón - brown	2200-4- 003	8414419220041	 x20	 8414419849495
	beige - beige	2200-6- 003	8414419220065	 x20	 8414419849518
2201	 Cablefix adhesivo 8 x 7 mm - Adhesive Cablefix 8 x 7 mm.				
	blanco - white	2201-2- 003	8414419220126	 x18	 8414419849532
	negro - black	2201-3- 003	8414419220133	 x18	 8414419849556
	marrón - brown	2201-4- 003	8414419220140	 x18	 8414419849570
	beige - beige	2201-6- 003	8414419220164	 x18	 8414419849594
	gris metalizado - silver grey	2201-7- 003	8414419220171	 x18	 8414419849617
2202	 Cablefix adhesivo 10,5 x 10 mm - Adhesive Cablefix 10,5 x 10 mm.				
	blanco - white	2202-2- 003	8414419220225	 x15	 8414419849631
	negro - black	2202-3- 000	8414419220232	 x15	 8414419854833
	marrón - brown	2202-4- 003	8414419220249	 x15	 8414419849655
	beige - beige	2202-6- 003	8414419220263	 x15	 8414419849679
	gris metalizado - silver grey	2202-7- 003	8414419220270	 x15	 8414419849693
2300	 Surtido colgadores baldosas adhesivas - Assortment of adhesive Barcelona slab hooks				
	blanco - white	2300-2- 000 incluye modelos 2301- 2302- 2303- 2304 - models included 2301, 2302, 2303 and 2304		 x20	 8414419804890
	gris - grey	2300-7- 000 incluye modelos 2301- 2302- 2303- 2304 - models included 2301, 2302, 2303 and 2304		 x20	 8414419804906
2301	 Colgador adhesivo baldosa rayada - Adhesive striped slab hook				
	blanco - white	2301-2- 000	8414419230125	 x20	 8414419804913
	gris - grey	2301-7- 000	8414419230170	 x20	 8414419804920
2302	 Colgador adhesivo baldosa trébol - Adhesive clover slab hook				
	blanco - white	2302-2- 000	8414419230224	 x20	 8414419804937
	gris - grey	2302-7- 000	8414419230279	 x20	 8414419804944
2303	 Colgador adhesivo baldosa círculo - Adhesive circles slab hook				
	blanco - white	2303-2- 000	8414419230323	 x20	 8414419804951
	gris - grey	2303-7- 000	8414419230378	 x20	 8414419804968
2304	 Colgador adhesivo baldosa cuadrada - Adhesive squares slab hook				
	blanco - white	2304-2- 000	8414419230422	 x20	 8414419804975
	gris - grey	2304-7- 000	8414419230477	 x20	 8414419804982



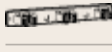





















































MODELO MODEL	COLOR COLOUR	ARTÍCULO ARTICLE	EAN ARTÍCULO EAN ARTICLE	EMBALAJE PACKING	EAN EMBALAJE EAN PACKING
2305		Colgador adhesivo semitransparente - Semitransparent adhesive hook			
	surtido - assortment	2305-0- 000		 x20	 8414419824904
		incluye colores verde- violeta- rosa - Colours included green-violet-pink			
	verde - green	2305-5- 000	8414419010895	 x20	 8414419824492
	violeta - violet	2305-8- 000	8414419010901	 x20	 8414419824515
	rosa - pink	2305-9- 000	8414419010918	 x20	 8414419824539
2310		Colgador adhesivo cuadrado - Adhesive square hook			
	floral azul - blue flowered	2310-A- 000	8414419012332	 x12	 8414419826168
	floral blanco - white flowered	2310-B- 000	8414419012349	 x12	 8414419826182
	floral amarillo - yellow flowered	2310-C- 000	8414419012356	 x12	 8414419826205
	floral rojo - red flowered	2310-F- 000	8414419012363	 x12	 8414419826229
	negro - black	2310-N- 000	8414419008823	 x12	 8414419818552
	floral surtido - assortment flowered	2310-S- 000		 x12	 8414419826144
		incluye surtido de amarillo - rojo - azul - blanco - Colours included yellow-red-blue-white			
	surtido - assortment	2310-0- 000		 x12	 8414419818446
		incluye surtido de blanco-naranja-verde-violeta-amarillo - Colours included white, orange, green, violet, yellow			
	blanco - white	2310-2- 000	8414419011168	 x12	 8414419818453
	naranja - orange	2310-4- 000	8414419011175	 x12	 8414419818460
	verde - green	2310-5- 000	8414419011182	 x12	 8414419818477
	chromo mate - matt chrome	2310-7- 000	8414419011199	 x12	 8414419818484
	violeta - violet	2310-8- 000	8414419011205	 x12	 8414419818491
	amarillo - yellow	2310-9- 000	8414419011212	 x12	 8414419818507
2311		Colgador adhesivo circular - Adhesive circular hook			
	negro - black	2311-N- 000	8414419011007	 x14	 8414419818613
	surtido - assortment	2311-0- 000		 x14	 8414419821101
		incluye surtido de blanco-naranja-verde-rojo-violeta-rosa - Colours included white, orange, green, red, violet, pink			
	blanco - white	2311-2- 000	8414419011229	 x14	 8414419818392
	naranja - orange	2311-4- 000	8414419011236	 x14	 8414419818408
	verde - green	2311-5- 000	8414419011243	 x14	 8414419818415
	rojo - red	2311-6- 000	8414419011519	 x14	 8414419820746
	chromo mate - matt chrome	2311-7- 000	8414419011250	 x14	 8414419818422
	violeta - violet	2311-8- 000	8414419011526	 x14	 8414419820876
	rosa - pink	2311-9- 000	8414419011533	 x14	 8414419820920
2312		Colgador adhesivo - Adhesive rectangular hook			
	beige satinado - satin beige	2312-B- 000	8414419011144	 x6	 8414419818323
	marrón satinado - satin brown	2312-M- 000	8414419011151	 x6	 8414419818316
	negro - black	2312-N- 000	8414419009356	 x6	 8414419818668

MODELO MODEL	COLOR COLOUR	ARTÍCULO ARTICLE	EAN ARTÍCULO EAN ARTICLE	EMBALAJE PACKING	EAN EMBALAJE EAN PACKING
	blanco - white	2312-2- 000	8414419008779	 x6	 1 8414419818217
	chromo mate - matt chrome	2312-7- 000	8414419008786	 x6	 1 8414419818224
2320	 Colgador adhesivo - Adhesive hook				
	wengué - wengue	2320-0- 000	8414419232006	 x12	 1 8414419820654
	haya - beech	2320-8- 000	8414419232082	 x12	 1 8414419820661
2351	 Sujetapapeles caras - Adhesive note holder				
	surtido - assortment	2351-0- .C1 incluye surtido de rojo-verde y violeta-amarillo - red-green and violet-yellow included		 x20	 2 8414419821583
	surtido - assortment	2351-0- CC1 caja expositora de 24 blisters surtidos - Counter display box of 24 assorted blisters		 x24	 2 8414419821644
	surtido - assortment	2351-0- RC1 ristra de 10 blisters - strings of 10 blisters		 x40	 2 8414419821637
	rojo - verde - red-green	2351-45 .C1	8414419011588	 x20	 2 8414419821590
	rojo - verde - red-green	2351-45 RC1	8414419011588	 x40	 2 8414419821613
	violeta - amarillo - violet - yellow	2351-89 .C1	8414419011595	 x20	 2 8414419821606
	violeta - amarillo - violet - yellow	2351-89 RC1	8414419011595	 x40	 2 8414419821620
2405	 Canaleta adhesiva con tapa bisagra 9 x 5 mm - Adhesive cable duct with hinge cover 9 x 5 mm.				
	blanco - white	2405-2G 000	8414419240520	 x20	 2 8414419801462
	negro - black	2405-8G 000	8414419240582	 x20	 2 8414419835085
2406	 Canaleta adhesiva con tapa bisagra 12 x 7 mm - Adhesive cable duct with hinge cover 12 x 7 mm.				
	blanco - white	2406-2G 000	8414419240629	 x20	 2 8414419807839
	roble - oak	2406-3G 000	8414419240636	 x20	 2 8414419811218
	sapelly - sapelly	2406-4G 000	8414419240643	 x20	 2 8414419819962
	negro - black	2406-8G 000	8414419240681	 x20	 2 8414419835108
	cerezo - cherry tree	2406-9G 000	8414419240698	 x20	 2 8414419811225
2407	 Canaleta adhesiva con tapa bisagra 16 x 10 mm - Adhesive cable duct with hinge cover 16 x 10 mm.				
	blanco - white	2407-2G 000	8414419240728	 x20	 2 8414419811232
	roble - oak	2407-3G 000	8414419240735	 x20	 2 8414419811249
	sapelly - sapelly	2407-4G 000	8414419240742	 x20	 2 8414419819979
	gris metalizado - silver grey	2407-7G 000	8414419240773	 x20	 2 8414419811256
	negro - black	2407-8G 000	8414419240780	 x20	 2 8414419811263
	cerezo - cherry tree	2407-9G 000	8414419240797	 x20	 2 8414419811270
2408	 Canaleta adhesiva con tapa bisagra 21 x 11,5 mm - Adhesive cable duct with hinge cover 21 x 11,5 mm.				
	blanco - white	2408-2G 000	8414419240827	 x15	 2 8414419811287
	roble - oak	2408-3G 000	8414419240834	 x15	 2 8414419811294





























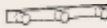























MODELO MODEL	COLOR COLOUR	ARTÍCULO ARTICLE	EAN ARTÍCULO EAN ARTICLE	EMBALAJE PACKING	EAN EMBALAJE EAN PACKING
	sapelly - sapelly	2408-4G 000	8414419240841	 x15	 8414419819986
	gris metalizado - silver grey	2408-7G 000	8414419240872	 x15	 8414419819993
	negro - black	2408-8G 000	8414419240889	 x15	 8414419835092
	cerezo - cherry tree	2408-9G 000	8414419240896	 x15	 8414419811300
2419	 Tope cilíndrico de acero inoxidable con adhesivo extra fuerte - Stainless steel cylindrical adhesive doorstop				
	acero inox. - stainless steel	2419-7- 000	8414419241978	 x8  1	8414419836495
2420	 Tope amortiguador adhesivo - Adhesive door stop with shock-absorption effect				
	blanco - white	2420-2- 000	8414419011267	 x10  1	8414419814974
	marrón - brown	2420-4- 000	8414419011274	 x10  1	8414419819597
	beige - beige	2420-6- 000	8414419011281	 x10  1	8414419819603
	cromado mate - matt chrome	2420-7- 000	8414419011298	 x10  1	8414419819610
	negro - black	2420-8- 000	8414419011304	 x10  1	8414419819627
	madera - wood	2420-9- 000	8414419242098	 x10  1	8414419818514
2450	 Tope de pared adhesivo - Wall adhesive door stop				
	blanco - white	2450-2- 000	8414419245020	 x16  2	8414419817494
	negro - black	2450-3- 000	8414419245037	 x16  2	8414419817500
	marrón - brown	2450-4- 000	8414419245044	 x16  2	8414419821767
	beige - beige	2450-6- 000	8414419245068	 x16  2	8414419822023
	cromo mate blanco - matt chrome white	2450-7- 000	8414419245075	 x16  2	8414419817517
	cromo mate negro - matt chrome black	2450-8- 000	8414419245082	 x16  2	8414419817524
2460	 Topes pared adhesivos decorados - Assortment of decorated wall adhesive door stops				
	surtido - assortment	2460-0- 000	8414419246003 incluye modelos 2461 - 2462- 2463 - 2464 - models included 2461 - 2462- 2463 - 2464	 x16  1	8414419246003
	surtido - assortment	2460-0C 000	8414419010789 caja expositora incluye modelos 2461 - 2462- 2463 - 2464 - Counter display box. Models included 2461-2462-2463-24	 x48  1	8414419010789
2461	 Tope pared adhesivo oso - Wall door stop (bear)				
	naranja - orange	2461-0- 000	8414419246102	 x16  1	8414419810464
2462	 Tope pared adhesivo flor - Wall door stop (flower)				
	rosa - pink	2462-0- 000	8414419246201	 x16  1	8414419810471
2463	 Tope pared adhesivo pingüino - Wall door stop (penguin)				
	blanco - white	2463-0- 000	8414419246300	 x16  1	8414419810488
2464	 Tope pared adhesivo tortuga - Wall door stop (turtle)				
	verde - green	2464-0- 000	8414419246409	 x16  1	8414419810495
2600	 Canaleta adhesiva con tapa extraíble 16x10 mm - Adhesive cable duct with extraction cover 16 x 10 mm.				

























































MODELO MODEL	COLOR COLOUR	ARTÍCULO ARTICLE	EAN ARTÍCULO EAN ARTICLE	EMBALAJE PACKING	EAN EMBALAJE EAN PACKING
	blanco - white	2600-2G 000	8414419260023	 x20	 8414419811317
	roble - oak	2600-3G 000	8414419260030	 x20	 8414419008274
	cerezo - cherry tree	2600-9G 000	8414419260092	 x20	 8414419811324
2601		Canaleta adhesiva con tapa extraíble 16 x 16 mm - Adhesive cable duct with extraction cover 16 x 16 mm.			
	blanco - white	2601-2G 000	8414419260122	 x20	 8414419811331
2602		Canaleta adhesiva con tapa extraíble 25 x 16 mm - Adhesive cable duct with extraction cover 25 x 16 mm.			
	blanco - white	2602-2G 000	8414419260221	 x15	 8414419811348
3000		Colgador pared - Nail-in hook			
	transparente - transparent	3000-0- 000	8414419300002	 x20	 10 8414419838543
	blanco - white	3000-2- 000	8414419300026	 x20	 10 8414419805194
	blanco - white	3000-2- R01	8414419300026	 x50	 10 8414419809239
		ristra de 10 blisters - strings of 10 blisters			
3001		Colgador pared - Nail hook			
	transparente - transparent	3001-0- 000	8414419300101	 x20	 6 8414419838567
	blanco - white	3001-2- 000	8414419300125	 x20	 6 8414419805200
	blanco - white	3001-2- R01	8414419300125	 x50	 6 8414419809246
		ristra de 10 blisters - strings of 10 blisters			
3002		Colgador pared - Nail hook			
	transparente - transparent	3002-0- 000	8414419300200	 x20	 4 8414419838581
	blanco - white	3002-2- 000	8414419300224	 x20	 4 8414419805217
	blanco - white	3002-2- R01	8414419300224	 x50	 4 8414419809253
		ristra de 10 blisters - strings of 10 blisters			
3010		Cuña madera - Wooden furniture wedge			
	haya - beech	3010-8- 001	8414419301085	 x10	 3 8414419827004
3011		Patín bombona butano - Butane skid			
	naranja - orange	3011-4- 002	8414419301146	 x40	 1 8414419849464
	naranja - orange	3011-4- 000	8414419301146	 x10	 1 8414419805231
3012		Cuña de plástico - Plastic furniture wedge			
	transparente - transparent	3012-0- 000	8414419301207	 x10	 3 8414419837829
	marrón - brown	3012-4- 000	8414419301245	 x10	 3 8414419827028
3013		Cuña niveladora - Levelling wedge			
	transparente - transparent	3013-0- 000	8414419301306	 x6	 4 8414419854246
3014		Cuña para puertas - Door wedge			
	transparente - transparent	3014-0- 000	8414419301405	 x6	 2 8414419854260























































MODELO MODEL	COLOR COLOUR	ARTÍCULO ARTICLE	EAN ARTÍCULO EAN ARTICLE	EMBALAJE PACKING	EAN EMBALAJE EAN PACKING
3015	 Filtro para sumidero Ø 42-62 mm. - Drain filter Ø 42-62 mm.				
	acero - steel	3015-1- 000	8414419301511	 x20  1	8414419805255
	blanco - white	3015-2- 000	8414419301528	 x20  1	8414419805262
3016	 Filtro para sumidero Ø 52-72 mm. - Drain filter Ø 52-72 mm.				
	acero - steel	3016-1- 000	8414419301610	 x20  1	8414419805279
	blanco - white	3016-2- 000	8414419301627	 x20  1	8414419805286
3021	 Pestillo para puerta con tornillos - Door latch with screws				
	plata - silver	3021-1- 000	8414419302112	 x12  1	8414419811591
	marfil - ivory	3021-2- 000	8414419302129	 x12  1	8414419811607
	oro - gold	3021-6- 000	8414419302167	 x12  1	8414419811614
	madera clara - light wood	3021-8- 000	8414419302181	 x12  1	8414419811621
	madera oscura - dark wood	3021-9- 000	8414419302198	 x12  1	8414419811638
3022	 Pestillo para puerta con tornillos - Door latch with screws				
	blanco - white	3022-2- 000	8414419302228	 x12  1	8414419811645
3025	 Burlete bajo puerta flexible 950 mm - Flexible draft buster seal 950 mm				
	gris - grey	3025-7- 000	8414419302570	 x8  1	8414419839281
3033	 Colgador escobas doble - Two broom hook rack				
	blanco - white	3033-2- 000	8414419303324	 x6  1	8414419821125
	Cromo mate - matt chrome	3033-7- 000	8414419303379	 x6  1	8414419821132
3034	 Colgador escobas triple - Three broom hook rack				
	blanco - white	3034-2- 002	8414419303423	 x6  1	8414419821194
	negro mate - matt black	3034-3- 001	8414419303430	 x6  1	8414419848443
	nogal americano - hickory	3034-4- 001	8414419015982	 x6  1	8414419848405
	Cromo mate - matt chrome	3034-7- 000	8414419303478	 x6  1	8414419821200
3036	 Colgador herramientas jardinería - Tool hook				
	verde - green	3036-5H C01	8414419001572	 x50  1	8414419816039
	verde - green	3036-5- 000	8414419008656	 x8  2	8414419815933
	verde - green	3036-5H 000	8414419001572	 x50  1	8414419824553
3038	 Colgador herramientas jardinería triple - Three tool hook rack				
	verde - green	3038-5- 000	8414419303850	 x6  1	8414419821170
3040	 Tope de puerta con tornillo - Door stop with screw				
	blanco - white	3040-2- 000	8414419304024	 x10  2	8414419812475

MODELO MODEL	COLOR COLOUR	ARTÍCULO ARTICLE	EAN ARTÍCULO EAN ARTICLE	EMBALAJE PACKING	EAN EMBALAJE EAN PACKING
	marrón - brown	3040-4- 000	8414419304048	 x10	 8414419812499
	beige - beige	3040-6- 000	8414419304062	 x10	 8414419812505
3042		Tope de puerta con tornillo - Door stop with screw			
	blanco - white	3042-2- 000	8414419304222	 x12	 8414419818156
	marrón - brown	3042-4- 000	8414419304246	 x12	 8414419818170
	beige - beige	3042-6- 000	8414419304260	 x12	 8414419818187
3045		Tope madera con tornillo - Wooden door stop with screw			
	sapelly - sapelly	3045-0- 001	8414419304505	 x10	 8414419816787
	roble - oak	3045-3- 001	8414419304536	 x10	 8414419816794
	haya - beech	3045-8- 001	8414419304581	 x10	 8414419816800
3046		Tope madera con tornillo - Wooden door stop with screw			
	haya - beech	3046-8- 000	8414419304680	 x10	 8414419816817
3047		Tope alto caucho - Rubber door stop			
	marrón - brown	3047-4- 000	8414419304741	 x10	 8414419808898
	beige - beige	3047-6- 000	8414419304765	 x10	 8414419808904
	gris - grey	3047-7- 001	8414419304772	 x10	 8414419808911
3048		Tope mediano caucho - Rubber door stop			
	marfil - ivory	3048-2P 002	8414419010437	 x15	 8414419846135
3049		Tope de puerta metálico con tornillo - Metallic doorstop with screw			
	cromado - chrome	3049-1- 000	8414419304918	 x10	 8414419830387
	cromado - chrome	3049-1U 000	8414419012899	 x10	 8414419830424
	blanco - white	3049-2- 000	8414419304925	 x10	 8414419830394
	blanco - white	3049-2U 000	8414419012912	 x10	 8414419830448
	dorado - golden	3049-6- 000	8414419304963	 x10	 8414419830400
	dorado - golden	3049-6U 000	8414419012929	 x10	 8414419830462
	cromo mate - matt chrome	3049-7- 000	8414419304970	 x10	 8414419830417
	cromo mate - matt chrome	3049-7U 000	8414419012936	 x10	 8414419830486
3052		Colgador herramientas - Tool hook			
	zincado - zincated	3052-1- 000	8414419305212	 x6	 8414419821118
3053		Colgador herramientas - Tool hook			
	zincado - zincated	3053-1- 000	8414419305311	 x10	 8414419805422
3054		Tope para manilla de puerta - Door handle stop Ø15-Ø18 mm			
	transparente - transparent	3054-0- 000	8414419305403	 x10	 8414419842564

MODELO MODEL	COLOR COLOUR	ARTÍCULO ARTICLE	EAN ARTÍCULO EAN ARTICLE	EMBALAJE PACKING	EAN EMBALAJE EAN PACKING
3055		Colgador de acero individual - Single stainless steel hook			
	acero inox. - stainless steel	3055-1U 000	8414419013032	 x10 	8414419830691
	blanco - white	3055-2U 001	8414419012288	 x10 	8414419830646
	Cromo mate - matt chrome	3055-7U 001	8414419012295	 x10 	8414419830653
3056		Colgador de acero doble - Double stainless steel hook			
	acero inox. - stainless steel	3056-1U 000	8414419013049	 x10 	8414419830684
	blanco - white	3056-2U 001	8414419012301	 x10 	8414419830660
	Cromo mate - matt chrome	3056-7U 001	8414419012318	 x10 	8414419830677
3061		Colgador triple con tornillo - Three hook rack			
	Cromado - chrome	3061-1- 000	8414419306110	 x10 	8414419805439
	blanco - white	3061-2- 000	8414419306127	 x10 	8414419805446
3062		Colgador doble con tornillo - Two hook rack			
	Cromado - chrome	3062-1- 000	8414419306219	 x10 	8414419805477
	blanco - white	3062-2- 000	8414419306226	 x10 	8414419805484
3072		Colgador con tornillo - Two hook rack			
	blanco - white	3072-2- 000	8414419307223	 x10 	8414419805514
3073		Colgador triple con tornillo - Three hook rack			
	blanco - white	3073-2- 000	8414419307322	 x10 	8414419805521
3075		Colgador múltiple de ganchos móviles - Mobile hook rack			
	blanco - white	3075-2- 000	8414419307520	 x10 	8414419805538
3076		Colgador doble con tornillo - Two hook rack			
	blanco - white	3076-2- 000	8414419307629	 x10 	8414419805545
3077		Colgador triple con tornillo - Three hook rack			
	blanco - white	3077-2- 000	8414419307728	 x10 	8414419805552
3084		Colgador cocina 4 ganchos con tornillo - Four hook rack			
	acero - steel	3084-1- 000	8414419308411	 x10 	8414419805569
	blanco - white	3084-2- 000	8414419308428	 x10 	8414419805576
3086		Colgador cocina 6 ganchos con tornillo - Six hook rack			
	acero - steel	3086-1- 000	8414419308619	 x10 	8414419805583
	blanco - white	3086-2- 000	8414419308626	 x10 	8414419805590
	negro mate - matt black	3086-3- 000	8414419308633	 x10 	8414419848467
	nogal americano - hickory	3086-4- 000	8414419015999	 x10 	8414419848429



























































MODELO MODEL	COLOR COLOUR	ARTÍCULO ARTICLE	EAN ARTÍCULO EAN ARTICLE	EMBALAJE PACKING	EAN EMBALAJE EAN PACKING
3087		Colgador cilíndrico con tornillo - Cylindrical hanger			
	blanco - white	3087-2- 000	8414419008670	 x8	 8414419815957
	negro mate - matt black	3087-3- 000	8414419308732	 x8	 8414419845671
	Cromo mate - matt chrome	3087-7- 000	8414419008731	 x8	 8414419816183
3088		Colgador sobre-puerta - Over the door hanger			
	blanco - white	3088S2- 500	8414419014282	 x6	 8414419834972
	negro mate - matt black	3088S3- 500	8414419016255	 x6	 8414419846227
	Cromo mate - matt chrome	3088S7- 500	8414419014251	 x6	 8414419834989
	blanco - white	3088-2- 000	8414419308824	 x6	 8414419805637
	Cromo mate - matt chrome	3088-7- 000	8414419308879	 x6	 8414419805644
3089		Colgador cilíndrico triple con tornillo - Three hook rack			
	blanco - white	3089-2- 000	8414419308923	 x6	 8414419805668
	negro mate - matt black	3089-3- 000	8414419308930	 x6	 8414419846302
	Cromo mate - matt chrome	3089-7- 000	8414419308978	 x6	 8414419805675
3093		Colgador triple - Three hook rack			
	beige satinado - satin beige	3093-B- 000	8414419011311	 x5	 8414419820012
	marrón satinado - satin brown	3093-M- 000	8414419011328	 x5	 8414419820029
	blanco - white	3093-2- 000	8414419309326	 x5	 8414419818330
	Cromo mate - matt chrome	3093-7- 000	8414419309371	 x5	 8414419818347
3100		Taco fijación canaleta - Fixing plug for cable duct			
	blanco - white	3100-9- 000	8414419310025	 x20	 20 8414419805774
3104		Soporte antivibración - Anti-vibration pads			
	negro - black	3104-3- 000	8414419012561	 x8	 4 8414419829664
3106		Rasca vidrios - Window scraper			
	negro-amarillo - black-yellow	3106-7- 000	8414419310674	 x40	 1 8414419805781
3107		Recambio cuchillas rascavidrios - Spare blades for window scraper			
	acero - steel	3107-1- 001	8414419310711	 x30	 5 8414419805798
3112		Patín deslizante metálico Ø 15 mm - Metallic glider Ø15 mm.			
	acero - steel	3112-1- 000	8414419311213	 x20	 8 8414419805804
3113		Patín deslizante metálico Ø 18 mm - Metallic glider Ø18 mm.			
	acero - steel	3113-1- 000	8414419311312	 x20	 8 8414419805811
3114		Patín deslizante metálico Ø 23 mm - Metallic glider Ø23 mm.			

























MODELO MODEL	COLOR COLOUR	ARTÍCULO ARTICLE	EAN ARTÍCULO EAN ARTICLE	EMBALAJE PACKING	EAN EMBALAJE EAN PACKING
	acero - steel	3114-1- 000	8414419311411	 x20	 8414419805828
3115	 Patín deslizante metálico Ø 26 mm - Metallic glider Ø26 mm.				
	acero - steel	3115-1- 000	8414419311510	 x20	 8414419810112
3116	 Patín deslizante metálico Ø 30 mm - Metallic glider Ø30 mm.				
	acero - steel	3116-1- 000	8414419311619	 x20	 8414419810105
3121	 Tapajuntas con tornillo 820 mm - Coverstrips with screws 820 mm.				
	acero inox. - stainless steel	3121-1- 000	8414419312111	 x20	 8414419805859
	latón - brass	3121-6- 000	8414419312166	 x20	 8414419805866
3122	 Tapajuntas con tornillo 985 mm - Coverstrips with screws 985 mm.				
	acero inox. - stainless steel	3122-1- 000	8414419312210	 x20	 8414419805873
	latón - brass	3122-6- 000	8414419312265	 x20	 8414419805880
3124	 Tapajuntas con tornillo 820 mm - Coverstrips with screws 820 mm.				
	acero inox. - stainless steel	3124-1- 000	8414419312418	 x20	 8414419805934
	roble ibérico - iberian oak	3124-3- 000	8414419312432	 x20	 8414419805941
	latón - brass	3124-6- 000	8414419312463	 x20	 8414419805958
	sapelly ugandés - ugandan sapelly	3124-8- 000	8414419312487	 x20	 8414419805965
3125	 Tapajuntas con tornillo 985 mm - Coverstrips with screws 985 mm.				
	acero inox. - stainless steel	3125-1- 000	8414419312517	 x20	 8414419805972
	roble ibérico - iberian oak	3125-3- 000	8414419312531	 x20	 8414419805989
	latón - brass	3125-6- 000	8414419312562	 x20	 8414419805996
	sapelly ugandés - ugandan sapelly	3125-8- 000	8414419312586	 x20	 8414419806009
3127	 Tapajuntas con tornillo 820 mm - Coverstrips with screws 820 mm.				
	acero inox. - stainless steel	3127-1- 000	8414419312715	 x20	 8414419806054
	roble ibérico - iberian oak	3127-3- 000	8414419312739	 x20	 8414419806061
	latón - brass	3127-6- 000	8414419312760	 x20	 8414419806078
	sapelly ugandés - ugandan sapelly	3127-8- 000	8414419312784	 x20	 8414419806085
3128	 Tapajuntas con tornillo 985 mm - Coverstrips with screws 985 mm.				
	acero inox. - stainless steel	3128-1- 000	8414419312814	 x20	 8414419806092
	roble ibérico - iberian oak	3128-3- 000	8414419312838	 x20	 8414419806108
	latón - brass	3128-6- 000	8414419312869	 x20	 8414419806115
	sapelly ugandés - ugandan sapelly	3128-8- 000	8414419312883	 x20	 8414419806122
3130	 Tapacables con tornillo 1000 mm - Cable cover with screws 1000 mm.				
	acero - steel	3130-1- 000	8414419313019	 x20	 8414419806177







































MODELO MODEL	COLOR COLOUR	ARTÍCULO ARTICLE	EAN ARTÍCULO EAN ARTICLE	EMBALAJE PACKING	EAN EMBALAJE EAN PACKING	
3132		Tapajuntas con tornillo 820 mm - Coverstrips with screws 820 mm.				
		acero inox. - stainless steel	3132-1- 000	8414419313217	 x20 	8414419806191
		latón - brass	3132-6- 000	8414419313262	 x20 	8414419806207
3133		Tapajuntas con tornillo 985 mm - Coverstrips with screws 985 mm.				
		acero inox. - stainless steel	3133-1- 000	8414419313316	 x20 	8414419806214
		latón - brass	3133-6- 000	8414419313361	 x20 	8414419806221
3135		Tapajuntas con tornillo 820 mm - Coverstrips with screws 820 mm.				
		acero inox. - stainless steel	3135-1- 000	8414419313514	 x20 	8414419806276
		roble ibérico - iberian oak	3135-3- 000	8414419313538	 x20 	8414419806283
		latón - brass	3135-6- 000	8414419313569	 x20 	8414419806290
		sapelly ugandés - ugandan sapelly	3135-8- 000	8414419313583	 x20 	8414419806306
3136		Tapajuntas con tornillo 985 mm - Coverstrips with screws 985 mm.				
		acero inox. - stainless steel	3136-1- 000	8414419313613	 x20 	8414419806313
		roble ibérico - iberian oak	3136-3- 000	8414419313637	 x20 	8414419806320
		latón - brass	3136-6- 000	8414419313668	 x20 	8414419806337
		sapelly ugandés - ugandan sapelly	3136-8- 000	8414419313682	 x20 	8414419806344
3138		Tapajuntas con tornillo 820 mm - Coverstrips with screws 820 mm.				
		acero inox. - stainless steel	3138-1- 000	8414419313811	 x20 	8414419806399
		roble ibérico - iberian oak	3138-3- 000	8414419313835	 x20 	8414419806405
		latón - brass	3138-6- 000	8414419313866	 x20 	8414419806412
		sapelly ugandés - ugandan sapelly	3138-8- 000	8414419313880	 x20 	8414419806429
3139		Tapajuntas con tornillo 985 mm - Coverstrips with screws 985 mm.				
		acero inox. - stainless steel	3139-1- 000	8414419313910	 x20 	8414419806436
		roble ibérico - iberian oak	3139-3- 000	8414419313934	 x20 	8414419806443
		latón - brass	3139-6- 000	8414419313965	 x20 	8414419806450
		sapelly ugandés - ugandan sapelly	3139-8- 000	8414419313989	 x20 	8414419806467
3140		Patín deslizante plástico Ø 15 mm - Plastic glider Ø15 mm.				
	marrón - brown	3140-4- 000	8414419314047	 x20 	8414419806474	
3141		Patín deslizante plástico Ø 18 mm - Plastic glider Ø18 mm.				
	marrón - brown	3141-4- 000	8414419314146	 x20 	8414419806481	
3142		Patín deslizante plástico Ø 20 mm - Plastic glider Ø20 mm.				
	marrón - brown	3142-4- 000	8414419314245	 x20 	8414419806498	











































MODELO MODEL	COLOR COLOUR	ARTÍCULO ARTICLE	EAN ARTÍCULO EAN ARTICLE	EMBALAJE PACKING	EAN EMBALAJE EAN PACKING
3145		Patín deslizante fieltro Ø 17 mm - Felt glider Ø17 mm.			
	marrón - brown	3145-4-001	8414419314542	 x10 	8414419820937
3146		Patín deslizante fieltro Ø 20 mm - Felt glider Ø20 mm.			
	marrón - brown	3146-4-001	8414419314641	 x10 	8414419820951
3147		Patín deslizante fieltro Ø 24 mm - Felt glider Ø24 mm.			
	marrón - brown	3147-4-001	8414419314740	 x10 	8414419820975
3148		Patín deslizante fieltro Ø 30 mm - Felt glider Ø30 mm.			
	marrón - brown	3148-4-001	8414419314849	 x10 	8414419820999
3149		Patín deslizante fieltro Ø 35 mm - Felt glider Ø35 mm.			
	marrón - brown	3149-4-001	8414419314948	 x10 	8414419821019
3160		Tope puerta con tórica - Metal door stop			
	latón - brass	3160-6-000	8414419316065	 x10 	8414419812529
	acero inox. - stainless steel	3160-7-000	8414419316072	 x10 	8414419812536
	acero inox. - stainless steel	3160-7P-002	8414419011779	 x10 	8414419835245
3162		Tope puerta alto con amortiguador - Stainless steel door stop			
	acero inox. - stainless steel	3162-7-000	8414419316270	 x10 	8414419808997
3163		Tope puerta semi-esférico - Semispherical stainless steel door stop			
	acero inox. - stainless steel	3163-7-000	8414419316379	 x12 	8414419818149
3164		Tope de pared en acero inoxidable - Stainless steel wall door stop			
	acero - steel	3164-7-000	8414419316478	 x6 	8414419806559
3165		Tope de pared de madera - Wooden wall door stop			
	sapelly - sapelly	3165-0-000	8414419316508	 x6 	8414419806566
	haya - beech	3165-8-000	8414419316584	 x6 	8414419806573
3166		Retenedor magnético metálico - Magnetic metallic door retainer			
	acero - steel	3166-7-000	8414419316676	 x8 	8414419833159
	acero - steel	3166-7U-000	8414419013544	 x10 	8414419833135
3167		Retenedor magnético metálico de pared - Wall magnetic metallic door retainer			
	acero inox. - stainless steel	3167-7-000	8414419316775	 x8 	8414419833166
	acero inox. - stainless steel	3167-7U-000	8414419013551	 x10 	8414419833142
3170		Retenedor puerta de pie - Foot-operated door retainer			
	blanco - white	3170-2-000	8414419317024	 x9 	8414419801493





































MODELO MODEL	COLOR COLOUR	ARTÍCULO ARTICLE	EAN ARTÍCULO EAN ARTICLE	EMBALAJE PACKING	EAN EMBALAJE EAN PACKING
	oro - gold	3170-3- 000	8414419317031	 x9 	8414419801509
	chromo mate - matt chrome	3170-7- 000	8414419317079	 x9 	8414419801547
	madera clara - light wood	3170-8- 000	8414419317086	 x9 	8414419816046
3171	 Retenedor de puerta flexible - Door flexible retainer				
	blanco - white	3171-2- 000	8414419317123	 x6 	8414419831674
3172	 Tope textil. Nudo - Door stop 1 Kg. Knot				
	natural - natural	3172-9- 001	8414419001527	 x2 	8414419846173
3173	 Tope textil. Marino - Door stop 1 Kg. Navy				
	azul - blue	3173-5- 000	8414419317352	 x2 	8414419841284
3174	 Tope textil. Saco - Door stop 1 Kg. Bag				
	beige - beige	3174-8- 000	8414419317482	 x2 	8414419841352
3175	 Tope textil. Cactus - Door stop 1 Kg. Cactus				
	verde - green	3175-3- 000	8414419317536	 x2 	8414419841260
3176	 Tope textil. Elefante - Door stop 1 Kg. Elephant				
	gris - grey	3176-8- 000	8414419317680	 x2 	8414419841291
3177	 Tope textil. Gallina - Door stop 1 Kg. Hen				
	beige - beige	3177-2- 000	8414419317727	 x2 	8414419841345
3178	 Tope textil. Gato - Door stop 1 Kg. Cat				
	blanco - white	3178-2- 000	8414419317826	 x2 	8414419844308
3179	 Tope textil. Perro - Door stop 1 Kg. Dog				
	marrón - brown	3179-4- 000	8414419317949	 x2 	8414419842113
3180	 Tope textil. Zorro - Door stop 1 Kg. Fox				
	rojo - red	3180-6- 000	8414419318069	 x2 	8414419841277
3181	 Tope textil Navideño 1 Kg. Gnomo gorro cuadros - Christmas fabric door stop 1 Kg. Gnome checkered pattern hat				
	rojo - red	3181-1- 000	8414419318113	 x2 	8414419846180
3182	 Tope textil Navideño 1 Kg. Gnomo gorro - Christmas fabric door stop 1 Kg. Gnome with hat				
	rojo - red	3182-1- 000	8414419318212	 x2 	8414419846197
3183	 Tope textil Navideño 1 Kg. Gnomo gorro - Christmas fabric door stop 1 Kg. Gnome with hat				
	gris - grey	3183-1- 000	8414419318311	 x2 	8414419846203
3200	 Enlaces surtidos para cablefix 2200 - Assorted joints for Cablefix 2200				





MODELO MODEL	COLOR COLOUR	ARTÍCULO ARTICLE	EAN ARTÍCULO EAN ARTICLE	EMBALAJE PACKING	EAN EMBALAJE EAN PACKING
	blanco - white	3200-2- 000	8414419320024	 x20 	8414419008182
	marrón - brown	3200-4- 000	8414419320048	 x20 	8414419806597
	beige - beige	3200-6- 000	8414419012134	 x20 	8414419834835
3201		Enlace recto para cablefix 2200 - Straight joints for Cablefix 2200			
	blanco - white	3201-2- 000	8414419320123	 x20 	8414419008199
	blanco - white	3201-2G 000		 x50 	8414419004993
	marrón - brown	3201-4- 000	8414419320147	 x20 	8414419806610
	marrón - brown	3201-4G 000		 x50 	8414419005006
	beige - beige	3201-6- 000	8414419014206	 x20 	8414419834842
3202		Enlace plano 90º para cablefix 2200 - Flat joints for Cablefix 2200			
	blanco - white	3202-2G 000		 x50 	8414419005013
	marrón - brown	3202-4G 000		 x50 	8414419004894
3203		Enlace cóncavo para cablefix 2200 - Concave joints for Cablefix 2200			
	blanco - white	3203-2G 000		 x50 	8414419004900
	marrón - brown	3203-4G 000		 x50 	8414419004917
3204		Enlace convexo para cablefix 2200 - Convex joints for Cablefix 2200			
	blanco - white	3204-2G 000		 x50 	8414419004924
	marrón - brown	3204-4G 000		 x50 	8414419004931
3205		Enlace "t" para cablefix 2200 - "T" joints for Cablefix 2200			
	blanco - white	3205-2G 000		 x50 	8414419004948
	marrón - brown	3205-4G 000		 x50 	8414419004955
3210		Enlaces surtidos para cablefix 2201 - Assorted joints for Cablefix 2201			
	blanco - white	3210-2- 000	8414419321021	 x20 	8414419008205
	negro - black	3210-3- 000	8414419321038	 x20 	8414419806634
	marrón - brown	3210-4- 000	8414419321045	 x20 	8414419008212
	beige - beige	3210-6- 000	8414419014213	 x20 	8414419834859
	gris metalizado - silver grey	3210-7- 000	8414419321076	 x20 	8414419806658
3211		Enlace recto para cablefix 2201 - Straight joints for Cablefix 2201			
	blanco - white	3211-2- 000	8414419321120	 x20 	8414419008229
	blanco - white	3211-2G 000		 x50 	8414419004818
	negro - black	3211-3- 000	8414419321137	 x20 	8414419806672
	negro - black	3211-3G 000		 x50 	8414419010048
	marrón - brown	3211-4- 000	8414419321144	 x20 	8414419008236

MODELO MODEL	COLOR COLOUR	ARTÍCULO ARTICLE	EAN ARTÍCULO EAN ARTICLE	EMBALAJE PACKING	EAN EMBALAJE EAN PACKING
	marrón - brown	3211-4G	000	 x50	u. 8414419004825
	beige - beige	3211-6-	000	 x20	 8414419834866
	gris metalizado - silver grey	3211-7-	000	 x20	 8414419806696
	gris metalizado - silver grey	3211-7G	000	 x50	u. 8414419010277
3212	 Enlace plano 90º para cablefix 2201 - Flat joints for Cablefix 2201				
	blanco - white	3212-2G	000	 x50	u. 8414419004832
	negro - black	3212-3G	000	 x50	u. 8414419010055
	marrón - brown	3212-4G	000	 x50	u. 8414419004849
	gris metalizado - silver grey	3212-7G	000	 x50	u. 8414419010284
3213	 Enlace cóncavo para cablefix 2201 - Concave joints for Cablefix 2201				
	blanco - white	3213-2G	000	 x50	u. 8414419004856
	negro - black	3213-3G	000	 x50	u. 8414419010062
	marrón - brown	3213-4G	000	 x50	u. 8414419004863
	gris metalizado - silver grey	3213-7G	000	 x50	u. 8414419010291
3214	 Enlace convexo para cablefix 2201 - Convex joints for Cablefix 2201				
	blanco - white	3214-2G	000	 x50	u. 8414419004870
	negro - black	3214-3G	000	 x50	u. 8414419010079
	marrón - brown	3214-4G	000	 x50	u. 8414419004887
	gris metalizado - silver grey	3214-7G	000	 x50	u. 8414419010307
3215	 Enlace "t" para cablefix 2201 - "T" joints for Cablefix 2201				
	blanco - white	3215-2G	000	 x50	u. 8414419004757
	negro - black	3215-3G	000	 x50	u. 8414419010086
	marrón - brown	3215-4G	000	 x50	u. 8414419004764
	gris metalizado - silver grey	3215-7G	000	 x50	u. 8414419010314
3220	 Enlaces surtidos para cablefix 2202 - Assorted joints for Cablefix 2202				
	blanco - white	3220-2-	000	 x20	 8414419008243
	negro - black	3220-3-	000	 x20	 8414419854864
	marrón - brown	3220-4-	000	 x20	 8414419806719
	beige - beige	3220-6-	000	 x20	 8414419834873
	gris metalizado - silver grey	3220-7-	000	 x20	 8414419806726
3221	 Enlace recto para cablefix 2202 - Straight joints for Cablefix 2202				
	blanco - white	3221-2-	000	 x20	 8414419008250
	blanco - white	3221-2G	000	 x50	u. 8414419004771
	negro - black	3221-3-	000	 x20	 8414419854871







MODELO MODEL	COLOR COLOUR	ARTÍCULO ARTICLE	EAN ARTÍCULO EAN ARTICLE	EMBALAJE PACKING	EAN EMBALAJE EAN PACKING
	negro - black	3221-3G 000		 x50	u. 8414419017139
	marrón - brown	3221-4- 000	8414419322141	 x20	 10 8414419806740
	marrón - brown	3221-4G 000		 x50	u. 8414419004788
	beige - beige	3221-6- 000	8414419014244	 x20	 10 8414419834880
	gris metalizado - silver grey	3221-7- 000	8414419322172	 x20	 10 8414419806757
	gris metalizado - silver grey	3221-7G 000		 x50	u. 8414419010321
3222		Enlace plano 90º para cablefix 2202 - Flat joints for Cablefix 2202			
	blanco - white	3222-2G 000		 x50	u. 8414419004795
	negro - black	3222-3G 000		 x50	u. 8414419017146
	marrón - brown	3222-4G 000		 x50	u. 8414419004801
	gris metalizado - silver grey	3222-7G 000		 x50	u. 8414419010338
3223		Enlace cóncavo para cablefix 2202 - Concave joints for Cablefix 2202			
	blanco - white	3223-2G 000		 x50	u. 8414419004665
	negro - black	3223-3G 000		 x50	u. 8414419017153
	marrón - brown	3223-4G 000		 x50	u. 8414419004672
	gris metalizado - silver grey	3223-7G 000		 x50	u. 8414419010345
3224		Enlace convexo para cablefix 2202 - Convex joints for Cablefix 2202			
	blanco - white	3224-2G 000		 x50	u. 8414419004689
	negro - black	3224-3G 000		 x50	u. 8414419017160
	marrón - brown	3224-4G 000		 x50	u. 8414419004696
	gris metalizado - silver grey	3224-7G 000		 x50	u. 8414419010352
3225		Enlace "t" para cablefix 2202 - "T" joints for Cablefix 2202			
	blanco - white	3225-2G 000		 x50	u. 8414419004702
	negro - black	3225-3G 000		 x50	u. 8414419017177
	marrón - brown	3225-4G 000		 x50	u. 8414419004719
	gris metalizado - silver grey	3225-7G 000		 x50	u. 8414419010369
3390		Accesorios surtidos para canaleta 9 x 5 mm - Assorted joints for cable duct 9x5 mm.			
	blanco - white	3390-2- 000	8414419339026	 x20	 7 8414419806764
	negro - black	3390-8- 000	8414419339088	 x20	 7 8414419835115
3391		Enlace recto para canaleta 9 x 5 mm - Straight joint for cable duct 9x5 mm.			
	blanco - white	3391-2G 000		 x25	u. 8414419004726
	negro - black	3391-8G 000		 x25	u. 8414419339187
3392		Enlace plano 90º para canaleta 9 x 5 mm - Flat joint for cable duct 9x5 mm.			

MODELO MODEL	COLOR COLOUR	ARTÍCULO ARTICLE	EAN ARTÍCULO EAN ARTICLE	EMBALAJE PACKING	EAN EMBALAJE EAN PACKING
	blanco - white	3392-2G	000	 x25	u. 8414419004733
	negro - black	3392-8G	000	 x25	u. 8414419339286
3393		Enlace cóncavo para canaleta 9 x 5mm - Concave joint for cable duct 9x5 mm.			
	blanco - white	3393-2G	000	 x25	u. 8414419004740
	negro - black	3393-8G	000	 x25	u. 8414419835139
3394		Enlace convexo para canaleta 9 x 5 mm - Convex joint for cable duct 9x5 mm.			
	blanco - white	3394-2G	000	 x25	u. 8414419004610
	negro - black	3394-8G	000	 x25	u. 8414419339484
3395		Enlace "t" para canaleta 9 x 5 mm - "T" joint for cable duct 9x5 mm.			
	blanco - white	3395-2G	000	 x25	u. 8414419004627
	negro - black	3395-8G	000	 x25	u. 8414419339583
3401		Canaleta con tapa bisagra 12 x 7 mm - Cable duct with hinge cover 12x7 mm.			
	blanco - white	3401-2G	000	8414419340121	 x20  8414419811355
3402		Canaleta con tapa bisagra 16 x 10 mm - Cable duct with hinge cover 16x10 mm.			
	blanco - white	3402-2G	000	8414419340220	 x20  8414419811386
3403		Canaleta con tapa bisagra 21 x 11,5 mm - Cable duct with hinge cover 21x11,5 mm.			
	blanco - white	3403-2G	000	8414419340329	 x15  8414419811423
3404		Canaleta con tapa bisagra 30 x 11,5 mm - Cable duct with hinge cover 30x11,5 mm.			
	blanco - white	3404-2G	000	8414419340428	 x15  8414419811454
	gris metalizado - silver grey	3404-7G	000	8414419340473	 x15  8414419811461
3410		Accesorios surtidos para canaleta 12 x 7 mm - Assorted joints for cable duct 12x7 mm.			
	blanco - white	3410-2-	000	8414419341029	 x20  8414419806771
	roble - oak	3410-3-	000	8414419341036	 x20  8414419806788
	sapelly - sapelly	3410-4-	000	8414419011342	 x20  8414419820043
	negro - black	3410-8-	000	8414419341081	 x20  8414419835122
	cerezo - cherry tree	3410-9-	000	8414419341098	 x20  8414419806795
3411		Enlace recto para canaleta 12 x 7 mm - Straight joint for cable duct 12x7 mm.			
	blanco - white	3411-2G	000	 x25	u. 8414419004634
	roble - oak	3411-3G	000	 x25	u. 8414419007956
	sapelly - sapelly	3411-4G	000	 x25	u. 8414419821811
	negro - black	3411-8G	000	 x25	u. 8414419341180
	cerezo - cherry tree	3411-9G	000	 x25	u. 8414419007963







MODELO MODEL	COLOR COLOUR	ARTÍCULO ARTICLE	EAN ARTÍCULO EAN ARTICLE	EMBALAJE PACKING	EAN EMBALAJE EAN PACKING
3412		Enlace plano 90º para canaleta 12 x 7 mm - Flat joint for cable duct 12x7 mm.			
	blanco - white	3412-2G	000	 x25	u. 8414419004641
	roble - oak	3412-3G	000	 x25	u. 8414419007970
	sapelly - sapelly	3412-4G	000	 x25	u. 8414419821828
	negro - black	3412-8G	000	 x25	u. 8414419341289
	cerezo - cherry tree	3412-9G	000	 x25	u. 8414419007987
3413		Enlace cóncavo para canaleta 12 x 7 mm - Concave joint for cable duct 12x7 mm.			
	blanco - white	3413-2G	000	 x25	u. 8414419004658
	roble - oak	3413-3G	000	 x25	u. 8414419007994
	sapelly - sapelly	3413-4G	000	 x25	u. 8414419821835
	negro - black	3413-8G	000	 x25	u. 8414419341388
	cerezo - cherry tree	3413-9G	000	 x25	u. 8414419008007
3414		Enlace convexo para canaleta 12 x 7 mm - Convex joint for cable duct 12x7 mm.			
	blanco - white	3414-2G	000	 x25	u. 8414419004535
	roble - oak	3414-3G	000	 x25	u. 8414419008014
	sapelly - sapelly	3414-4G	000	 x25	u. 8414419821842
	negro - black	3414-8G	000	 x25	u. 8414419341487
	cerezo - cherry tree	3414-9G	000	 x25	u. 8414419008021
3415		Enlace "t" para canaleta 12 x 7 mm - "T" joint for cable duct 12x7 mm.			
	blanco - white	3415-2G	000	 x25	u. 8414419004542
	roble - oak	3415-3G	000	 x25	u. 8414419008038
	sapelly - sapelly	3415-4G	000	 x25	u. 8414419821859
	negro - black	3415-8G	000	 x25	u. 8414419341586
	cerezo - cherry tree	3415-9G	000	 x25	u. 8414419008045
3420		Accesorios surtidos canaleta 16 x 10 mm - Assorted joints for cable duct 16x10 mm.			
	blanco - white	3420-2-	000	 x20	 8414419342026
	roble - oak	3420-3-	000	 x20	 8414419806818
	sapelly - sapelly	3420-4-	000	 x20	 84144198220050
	gris metalizado - silver grey	3420-7-	000	 x20	 8414419806825
	negro - black	3420-8-	000	 x20	 8414419806832
	cerezo - cherry tree	3420-9-	000	 x20	 8414419806849
3421		Enlace recto para canaleta 16 x 10 mm - Straight joint for cable duct 16x10 mm.			
	blanco - white	3421-2G	000	 x25	u. 8414419004559
	roble - oak	3421-3G	000	 x25	u. 8414419007468

MODELO MODEL	COLOR COLOUR	ARTÍCULO ARTICLE	EAN ARTÍCULO EAN ARTICLE	EMBALAJE PACKING	EAN EMBALAJE EAN PACKING
	sapelly - sapelly	3421-4G	000	 x25	u. 8414419821866
	gris metalizado - silver grey	3421-7G	000	 x25	u. 8414419008489
	negro - black	3421-8G	000	 x25	u. 8414419010093
	cerezo - cherry tree	3421-9G	000	 x25	u. 8414419007475







3422  **Enlace plano 90° para canaleta 16 x 10 mm - Flat joint for cable duct 16x10 mm.**

	blanco - white	3422-2G	000	 x25	u. 8414419004566
	roble - oak	3422-3G	000	 x25	u. 8414419007482
	sapelly - sapelly	3422-4G	000	 x25	u. 8414419821873
	gris metalizado - silver grey	3422-7G	000	 x25	u. 8414419008496
	negro - black	3422-8G	000	 x25	u. 8414419010109
	cerezo - cherry tree	3422-9G	000	 x25	u. 8414419007499







3423  **Enlace cóncavo para canaleta 16 x 10 mm - Concave joint for cable duct 16x10 mm.**

	blanco - white	3423-2G	000	 x25	u. 8414419004573
	roble - oak	3423-3G	000	 x25	u. 8414419007505
	sapelly - sapelly	3423-4G	000	 x25	u. 8414419821880
	gris metalizado - silver grey	3423-7G	000	 x25	u. 8414419008502
	negro - black	3423-8G	000	 x25	u. 8414419010116
	cerezo - cherry tree	3423-9G	000	 x25	u. 8414419007512



3424  **Enlace convexo para canaleta 16 x 10 mm - Convex joint for cable duct 16x10 mm.**



























































	blanco - white	3424-2G	000	 x25	u. 8414419004580
	roble - oak	3424-3G	000	 x25	u. 8414419007529
	sapelly - sapelly	3424-4G	000	 x25	u. 8414419821897
	gris metalizado - silver grey	3424-7G	000	 x25	u. 8414419008519
	negro - black	3424-8G	000	 x25	u. 8414419010123
	cerezo - cherry tree	3424-9G	000	 x25	u. 8414419007536

























3425  **Enlace "t" para canaleta 16 x 10 mm - "T" joint for cable duct 16x10 mm.**













	blanco - white	3425-2G	000	 x25	u. 8414419004597
	roble - oak	3425-3G	000	 x25	u. 8414419007543
	sapelly - sapelly	3425-4G	000	 x25	u. 8414419821903
	gris metalizado - silver grey	3425-7G	000	 x25	u. 8414419008526
	negro - black	3425-8G	000	 x25	u. 8414419010130
	cerezo - cherry tree	3425-9G	000	 x25	u. 8414419007550

3430  **Accesorios surtidos canaleta 21 x 11,5 mm - Assorted joints for cable duct 21x11,5 mm.**



















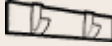



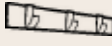







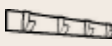







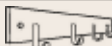







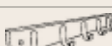

	blanco - white	3430-2-	000	8414419343023	 x20	 7 8414419809017
--	----------------	---------	-----	---------------	---	---















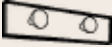



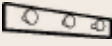







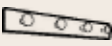























MODELO MODEL	COLOR COLOUR	ARTÍCULO ARTICLE	EAN ARTÍCULO EAN ARTICLE	EMBALAJE PACKING	EAN EMBALAJE EAN PACKING
	roble - oak	3430-3- 000	8414419343030	 x20 	8414419806863
	sapelly - sapelly	3430-4- 000	8414419011366	 x20 	8414419820067
	gris metalizado - silver grey	3430-7- 000	8414419011373	 x20 	8414419821569
	negro - black	3430-8- 000	8414419014275	 x20 	8414419835146
	cerezo - cherry tree	3430-9- 000	8414419343092	 x20 	8414419806870
3431		Enlace recto para canaleta 21 x 11,5 mm - Straight joint for cable duct 21x11,5 mm.			
	blanco - white	3431-2G 000		 x25 	8414419004603
	roble - oak	3431-3G 000		 x25 	8414419009226
	sapelly - sapelly	3431-4G 000		 x25 	8414419821910
	gris metalizado - silver grey	3431-7G 000		 x25 	8414419821965
	negro - black	3431-8G 000		 x25 	8414419343184
	cerezo - cherry tree	3431-9G 000		 x25 	8414419009233
3432		Enlace plano 90° para canaleta 21x11,5 mm - Flat joint for cable duct 21x11,5 mm.			
	blanco - white	3432-2G 000		 x25 	8414419004443
	roble - oak	3432-3G 000		 x25 	8414419009240
	sapelly - sapelly	3432-4G 000		 x25 	8414419821927
	gris metalizado - silver grey	3432-7G 000		 x25 	8414419821972
	negro - black	3432-8G 000		 x25 	8414419343283
	cerezo - cherry tree	3432-9G 000		 x25 	8414419009257
3433		Enlace cóncavo para canaleta 21 x 11,5 mm - Concave joint for cable duct 21x11,5 mm.			
	blanco - white	3433-2G 000		 x25 	8414419004450
	roble - oak	3433-3G 000		 x25 	8414419009264
	sapelly - sapelly	3433-4G 000		 x25 	8414419821934
	gris metalizado - silver grey	3433-7G 000		 x25 	8414419821989
	negro - black	3433-8G 000		 x25 	8414419343382
	cerezo - cherry tree	3433-9G 000		 x25 	8414419009271
3434		Enlace convexo para canaleta 21 x 11,5 mm - Convex joint for cable duct 21x11,5 mm.			
	blanco - white	3434-2G 000		 x25 	8414419004467
	roble - oak	3434-3G 000		 x25 	8414419009288
	sapelly - sapelly	3434-4G 000		 x25 	8414419821941
	gris metalizado - silver grey	3434-7G 000		 x25 	8414419821996
	negro - black	3434-8G 000		 x25 	8414419343481
	cerezo - cherry tree	3434-9G 000		 x25 	8414419009295
3435		Enlace "t" para canaleta 21 x 11,5 mm - "T" joint for cable duct 21x11,5 mm.			







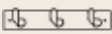





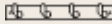

















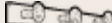

























MODELO MODEL	COLOR COLOUR	ARTÍCULO ARTICLE	EAN ARTÍCULO EAN ARTICLE	EMBALAJE PACKING	EAN EMBALAJE EAN PACKING
	blanco - white	3435-2G 000		 x25	u. 8414419004474
	roble - oak	3435-3G 000		 x25	u. 8414419009301
	sapelly - sapelly	3435-4G 000		 x25	u. 8414419821958
	gris metalizado - silver grey	3435-7G 000		 x25	u. 8414419822009
	negro - black	3435-8G 000		 x25	u. 8414419343580
	cerezo - cherry tree	3435-9G 000		 x25	u. 8414419009318
3440		Accesorios surtidos canaleta 30 x 11,5 mm - Assorted joints for cable duct 30x11,5 mm.			
	blanco - white	3440-2- 000	8414419344020	 x20	 7 8414419809024
	gris metalizado - silver grey	3440-7- 000	8414419344075	 x20	 7 8414419806894
3441		Enlace recto para canaleta 30 x 11,5 mm - Straight joint for cable duct 30x11,5 mm.			
	blanco - white	3441-2G 000		 x25	u. 8414419004481
	gris metalizado - silver grey	3441-7G 000		 x25	u. 8414419010147
3442		Enlace plano 90º para canaleta 30 x 11,5 mm - Flat joint for cable duct 30x11,5 mm.			
	blanco - white	3442-2G 000		 x25	u. 8414419004498
	gris metalizado - silver grey	3442-7G 000		 x25	u. 8414419010154
3443		Enlace cóncavo para canaleta 30 x 11,5 mm - Concave joint for cable duct 30x11,5 mm.			
	blanco - white	3443-2G 000		 x25	u. 8414419004504
	gris metalizado - silver grey	3443-7G 000		 x25	u. 8414419010161
3444		Enlace convexo para canaleta 30 x 11,5 mm - Convex joint for cable duct 30x11,5 mm.			
	blanco - white	3444-2G 000		 x25	u. 8414419004511
	gris metalizado - silver grey	3444-7G 000		 x25	u. 8414419010178
3445		Enlace "t" para canaleta 30 x 11,5 mm - "T" joint for cable duct 30x11,5 mm.			
	blanco - white	3445-2G 000		 x25	u. 8414419004528
	gris metalizado - silver grey	3445-7G 000		 x25	u. 8414419010185
3507		Deslizador de PTFE adhesivo Ø 30 mm - Glider for furniture Ø 30 mm			
	gris - grey	3507-7- 000	8414419350779	 x12	 4 8414419841307
	gris - grey	3507-7G 000		 x50	u. 8414419841390
3508		Deslizador de PTFE adhesivo Ø 40 mm - Glider for furniture Ø 40 mm			
	gris - grey	3508-7- 000	8414419350878	 x12	 4 8414419841321
3510		Deslizador de PTFE adhesivo Ø 25 mm - Adhesive glider in PTFE Ø 25 mm.			
	gris - grey	3510-7- 000	8414419351073	 x20	 4 8414419800243
3511		Deslizador de PTFE adhesivo Ø 50 mm - Adhesive glider in PTFE Ø 50 mm.			



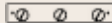



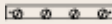



















































MODELO MODEL	COLOR COLOUR	ARTÍCULO ARTICLE	EAN ARTÍCULO EAN ARTICLE	EMBALAJE PACKING	EAN EMBALAJE EAN PACKING
	gris - grey	3511-7- 000	8414419351172	 x12 	8414419800274
3512		Deslizador de PTFE adhesivo Ø 63 mm - Adhesive glider in PTFE Ø 63 mm.			
	gris - grey	3512-7- 000	8414419351271	 x12 	8414419800304
3513		Deslizador de PTFE adhesivo 35x25 mm - Adhesive glider in PTFE 35x25 mm.			
	gris - grey	3513-7- 000	8414419351370	 x18 	8414419800090
3514		Deslizador de PTFE adhesivo 75x16 mm - Adhesive glider in PTFE 75x16 mm.			
	gris - grey	3514-7- 000	8414419351479	 x10 	8414419800120
3515		Deslizador de PTFE con clavo Ø 22 mm - Nail-fastening glider in PTFE Ø22 mm.			
	gris - grey	3515-7- 000	8414419351578	 x16 	8414419800151
3516		Deslizador de PTFE con tornillo Ø 22 mm - Screw-fastening glider in PTFE Ø22 mm.			
	gris - grey	3516-7- 000	8414419351677	 x20 	8414419800182
3517		Deslizador de PTFE con tornillo Ø 38 mm - Screw-fastening glider in PTFE Ø38 mm.			
	gris - grey	3517-7- 000	8414419351776	 x10 	8414419800212
3518		Deslizador de PTFE con tornillo Ø 30 mm - Glider for furniture with screw Ø 30 mm			
	gris - grey	3518-7- 000	8414419351875	 x12 	8414419841376
3600		Canaleta con tapa extraíble 16 x 10 mm - Cable duct with extraction cover 16x10 mm.			
	blanco - white	3600-2G 000	8414419360020	 x20 	8414419811478
3601		Canaleta con tapa extraíble 16 x 16 mm - Cable duct with extraction cover 16x16 mm.			
	blanco - white	3601-2G 000	8414419360129	 x20 	8414419811508
3602		Canaleta con tapa extraíble 25 x 16 mm - Cable duct with extraction cover 25x16 mm.			
	blanco - white	3602-2G 000	8414419360228	 x15 	8414419811515
3603		Canaleta con tapa extraíble 35 x 16 mm - Cable duct with extraction cover 35x16 mm.			
	blanco - white	3603-2G 000	8414419360327	 x15 	8414419811522
	gris metalizado - silver grey	3603-7G 000	8414419360372	 x15 	8414419811539
3604		Canaleta con tapa extraíble y 4 sujetacables móviles 53 x 20 mm - Cable duct with extraction cover and mobile cable holder 53x20 mm.			
	blanco - white	3604-2G 000	8414419360426	 x8 	8414419811546
3610		Accesorios surtidos canaleta 16 x 16 mm - Assorted joints for cable duct 16x16 mm.			
	blanco - white	3610-2- 000	8414419361027	 x20 	8414419806900
3611		Enlace recto para canaleta 16 x 16 mm - Straight joint for cable duct 16x16 mm.			
	blanco - white	3611-2G 000		 x25 	8414419007567













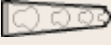









































MODELO MODEL	COLOR COLOUR	ARTÍCULO ARTICLE	EAN ARTÍCULO EAN ARTICLE	EMBALAJE PACKING	EAN EMBALAJE EAN PACKING
3612		Enlace plano 90º para canaleta 16 x 16 mm - Flat joint for cable duct 16x16 mm.			
	blanco - white	3612-2G	000	 x25	U. 8414419007574
3613		Enlace cóncavo para canaleta 16 x 16 mm - Concave joint for cable duct 16x16 mm.			
	blanco - white	3613-2G	000	 x25	U. 8414419007581
3614		Enlace convexo para canaleta 16 x 16 mm - Convex joint for cable duct 16x16 mm.			
	blanco - white	3614-2G	000	 x25	U. 8414419007598
3615		Enlace "t" para canaleta 16 x 16 mm - "T" joint for cable duct 16x16 mm.			
	blanco - white	3615-2G	000	 x25	U. 8414419007604
3620		Accesorios surtidos canaleta 25 x 16 mm - Assorted joints for cable duct 25x16 mm.			
	blanco - white	3620-2-	000 8414419362024	 x20	 7 8414419806917
3621		Enlace recto para canaleta 25 x 16 mm - Straight joint for cable duct 25x16 mm.			
	blanco - white	3621-2G	000	 x25	U. 8414419007611
3622		Enlace plano 90º para canaleta 25 x 16 mm - Flat joint for cable duct 25x16 mm.			
	blanco - white	3622-2G	000	 x25	U. 8414419007628
3623		Enlace cóncavo para canaleta 25 x 16 mm - Concave joint for cable duct 25x16 mm.			
	blanco - white	3623-2G	000	 x25	U. 8414419007635
3624		Enlace convexo para canaleta 25 x 16 mm - Convex joint for cable duct 25x16 mm.			
	blanco - white	3624-2G	000	 x25	U. 8414419007642
3625		Enlace "t" para canaleta 25 x 16 mm - "T" joint for cable duct 25x16 mm.			
	blanco - white	3625-2G	000	 x25	U. 8414419007659
3630		Accesorios surtidos canaleta 35 x 16 mm - Assorted joints for cable duct 35x16 mm.			
	blanco - white	3630-2-	000 8414419363021	 x20	 7 8414419806924
	gris metalizado - silver grey	3630-7-	000 8414419363076	 x20	 7 8414419806931
3631		Enlace recto para canaleta 35 x 16 mm - Straight joint for cable duct 35x16 mm.			
	blanco - white	3631-2G	000	 x25	U. 8414419007666
	gris metalizado - silver grey	3631-7G	000	 x25	U. 8414419010192
3632		Enlace plano 90º para canaleta 35 x 16 mm - Flat joint for cable duct 35x16 mm.			
	blanco - white	3632-2G	000	 x25	U. 8414419007673
	gris metalizado - silver grey	3632-7G	000	 x25	U. 8414419010208
3633		Enlace cóncavo para canaleta 35 x 16 mm - Concave joint for cable duct 35x16 mm.			



















































MODELO MODEL	COLOR COLOUR	ARTÍCULO ARTICLE	EAN ARTÍCULO EAN ARTICLE	EMBALAJE PACKING	EAN EMBALAJE EAN PACKING
	blanco - white	3633-2G	000	 x25	u. 8414419007680
	gris metalizado - silver grey	3633-7G	000	 x25	u. 8414419010215
3634		Enlace convexo para canaleta 35 x 16 mm - Convex joint for cable duct 35x16 mm.			
	blanco - white	3634-2G	000	 x25	u. 8414419007697
	gris metalizado - silver grey	3634-7G	000	 x25	u. 8414419010222
3635		Enlace "t" para canaleta 35 x 16 mm - "T" joint for cable duct 35x16 mm.			
	blanco - white	3635-2G	000	 x25	u. 8414419007703
	gris metalizado - silver grey	3635-7G	000	 x25	u. 8414419010239
3702		Colgador haya 2 ganchos - Two hook rack in beech wood			
	wengué - wengue	3702-0-	001	8414419370203	 x4  1 8414419806948
	natural - natural	3702-8-	001	8414419370289	 x4  1 8414419806955
3703		Colgador haya 3 ganchos - Three hook rack in beech wood			
	wengué - wengue	3703-0-	001	8414419370302	 x4  1 8414419806962
	blanco - white	3703-2-	001	8414419011540	 x4  1 8414419821316
	roble envejecido - old oak	3703-3-	000	8414419013438	 x4  1 8414419832459
	natural - natural	3703-8-	001	8414419370388	 x4  1 8414419806979
3704		Colgador haya 4 ganchos - Four hook rack in beech wood			
	wengué - wengue	3704-0-	001	8414419370401	 x4  1 8414419806986
	blanco - white	3704-2-	001	8414419011557	 x4  1 8414419821286
	roble envejecido - old oak	3704-3-	000	8414419013445	 x4  1 8414419832442
	natural - natural	3704-8-	001	8414419370487	 x4  1 8414419806993
3706		Colgador múltiple decorado - Multiple infantile peg			
	Elefante azul - Blue elephant	3706-A-	000	8414419012516	 x4  1 8414419827837
	Elefante rosa - Pink elephant	3706-B-	000	8414419012493	 x4  1 8414419827844
	Dino verde - Green dino	3706-C-	000	8414419012509	 x4  1 8414419827851
	Dino amarillo - Yellow dino	3706-D-	000	8414419012523	 x4  1 8414419827868
	surtido - assortment	3706-0-	000		 x4  1 8414419828476
3707		Colgador 5 ganchos - Five hooks peg			
	blanco - white	3707-A-	000	8414419012400	 x4  1 8414419829527
	turquesa - turquoise	3707-B-	000	8414419012424	 x4  1 8414419829534
	azul - blue	3707-C-	000	8414419012431	 x4  1 8414419829541
	lila - lilac	3707-D-	000	8414419012448	 x4  1 8414419829558
	rosa - pink	3707-F-	000	8414419012462	 x4  1 8414419829572



















































MODELO MODEL	COLOR COLOUR	ARTÍCULO ARTICLE	EAN ARTÍCULO EAN ARTICLE	EMBALAJE PACKING	EAN EMBALAJE EAN PACKING
	naranja - orange	3707-H- 000	8414419012486	 x4	 8414419829596
	verde - green	3707-M- 000	8414419017191	 x4	 8414419855410
3712		Colgador haya 2 pomos - Two hook rack in beech wood			
	wengué - wengue	3712-0- 001	8414419371200	 x4	 8414419807006
	natural - natural	3712-8- 001	8414419371286	 x4	 8414419807013
3713		Colgador haya 3 pomos - Three hook rack in beech wood			
	wengué - wengue	3713-0- 001	8414419371309	 x4	 8414419807020
	blanco - white	3713-2- 001	8414419011564	 x4	 8414419821293
	roble envejecido - old oak	3713-3- 000	8414419013421	 x4	 8414419832435
	natural - natural	3713-8- 001	8414419371385	 x4	 8414419807037
3714		Colgador haya 4 pomos - Four hook rack in beech wood			
	wengué - wengue	3714-0- 001	8414419371408	 x4	 8414419807044
	blanco - white	3714-2- 001	8414419011571	 x4	 8414419821309
	roble envejecido - old oak	3714-3- 000	8414419013414	 x4	 8414419832428
	natural - natural	3714-8- 001	8414419371484	 x4	 8414419807051
3716		Colgador acero inoxidable 3 ganchos - Stainless steel peg 3 hook			
	acero inox. - stainless steel	3716-1- 000	8414419371613	 x4	 8414419830585
3717		Colgador acero inoxidable 4 ganchos - Stainless steel peg 4 hook			
	acero inox. - stainless steel	3717-1- 000	8414419371712	 x4	 8414419830608
3718		Colgador acero inoxidable 3 ganchos dobles - Stainless steel peg 3 double hooks			
	acero inox. - stainless steel	3718-1- 000	8414419371811	 x4	 8414419830622
3719		Colgador 3 ganchos triples - Steel peg with 3 triple hooks			
	blanco - white	3719-2- 000	8414419371927	 x4	 8414419838130
	negro - black	3719-3- 000	8414419371934	 x4	 8414419838154
3720		Colgador sobre-puerta acero cromado 6 bolas - Over the door 3 double hook rack			
	colores - colors	3720-0- 000	8414419372009	 x4	 8414419838178
	blanco - white	3720-2- 000	8414419372023	 x4	 8414419838192
3721		Colgador sobre-puerta acero 4 ganchos dobles - Over the door 4 double hook rack			
	blanco - white	3721-2- 000	8414419372122	 x4	 8414419838215
	negro - black	3721-3- 000	8414419372139	 x4	 8414419838239
3723		Colgador fresno NORDIK 3 ganchos - NORDIK ash wood hook rack with 3 hooks			
	blanco - white	3723-2- 000	8414419372320	 x4	 8414419844995



















































MODELO MODEL	COLOR COLOUR	ARTÍCULO ARTICLE	EAN ARTÍCULO EAN ARTICLE	EMBALAJE PACKING	EAN EMBALAJE EAN PACKING
	negro - black	3723-3- 000	8414419372337	 x4	 1 8414419845015
3724		Colgador fresno NORDIK 4 ganchos - NORDIK ash wood hook rack with 4 hooks			
	blanco - white	3724-2- 000	8414419372429	 x4	 1 8414419845039
	negro - black	3724-3- 000	8414419372436	 x4	 1 8414419845053
3731		Colgador fresno individual con textura - Textured ash wood peg			
	blanco - white	3731-2- 000	8414419012073	 x8	 1 8414419825550
	verde - green	3731-5- 000	8414419012097	 x8	 1 8414419825574
	rojo - red	3731-6- 000	8414419012103	 x8	 1 8414419825581
	lila - lilac	3731-7- 000	8414419012110	 x8	 1 8414419825598
	natural - natural	3731-8- 000	8414419012080	 x8	 1 8414419825567
	rosa - pink	3731-9- 000	8414419012271	 x8	 1 8414419825604
3733		Colgador fresno 3 pomos con textura - Textured ash wood peg 3 hooks			
	blanco - white	3733-2- 001	8414419012141	 x4	 1 8414419825642
	verde - green	3733-5- 001	8414419012165	 x4	 1 8414419825673
	rojo - red	3733-6- 001	8414419012172	 x4	 1 8414419825680
	lila - lilac	3733-7- 001	8414419012189	 x4	 1 8414419825697
	natural - natural	3733-8- 001	8414419012158	 x4	 1 8414419825666
	rosa - pink	3733-9- 001	8414419012196	 x4	 1 8414419825703
3734		Colgador fresno 4 pomos con textura - Textured ash wood peg 4 hooks			
	blanco - white	3734-2- 001	8414419012219	 x4	 1 8414419825734
	verde - green	3734-5- 001	8414419012233	 x4	 1 8414419825758
	rojo - red	3734-6- 001	8414419012240	 x4	 1 8414419825765
	lila - lilac	3734-7- 001	8414419012257	 x4	 1 8414419825772
	natural - natural	3734-8- 001	8414419012226	 x4	 1 8414419825741
	rosa - pink	3734-9- 001	8414419012264	 x4	 1 8414419825789
3740		Surtido colgadores de latón - Brass hooks assortment			
	níquel satinado - satin nickel	3740-7- 000	incluye modelos 3750- 3751- 3752 - models included 3750, 3751 and 3752	 x12	 1 8414419818378
	latón satinado - satin brass	3740-9- 000	incluye modelos 3750- 3751- 3752 - models included 3750, 3751 and 3752	 x12	 1 8414419818385
3743		Colgador fresno ONA 3 pomos - ONA ash wood hook rack with 3 hooks			
	fresno calcáreo - limestone ash tree	3743-2- 000	8414419374324	 x4	 1 8414419845077
	fresno nórdico - nordic ash tree	3743-3- 000	8414419374331	 x4	 1 8414419845091
3744		Colgador fresno ONA 4 pomos - ONA ash wood hook rack with 4 hooks			
	fresno calcáreo - limestone ash tree	3744-2- 000	8414419374423	 x4	 1 8414419845114















































MODELO MODEL	COLOR COLOUR	ARTÍCULO ARTICLE	EAN ARTÍCULO EAN ARTICLE	EMBALAJE PACKING	EAN EMBALAJE EAN PACKING
	fresno nórdico - nordic ash tree	3744-3- 000	8414419374430	 x4 	8414419845138
3750	 Colgador de latón oriental - Oriental brass hook				
	níquel satinado - satin nickel	3750-7- 000	8414419375079	 x8 	8414419818255
	latón satinado - satin brass	3750-9- 000	8414419375093	 x8 	8414419818262
3751	 Colgador de latón tulipán - Tulip brass hook				
	níquel satinado - satin nickel	3751-7- 000	8414419375178	 x8 	8414419818279
	latón satinado - satin brass	3751-9- 000	8414419375192	 x8 	8414419818286
3752	 Colgador de latón flor - Flower brass hook				
	níquel satinado - satin nickel	3752-7- 000	8414419375277	 x8 	8414419818293
	latón satinado - satin brass	3752-9- 000	8414419375291	 x8 	8414419818309
3760	 Colgador clásico de latón - Brass hook				
	níquel satinado - satin nickel	3760-7- 000	8414419376076	 x12 	8414419822160
	latón satinado - satin brass	3760-9- 000	8414419376090	 x12 	8414419822177
3761	 Colgador clásico doble de latón - Double brass hook				
	níquel satinado - satin nickel	3761-7- 000	8414419376175	 x10 	8414419822184
	latón satinado - satin brass	3761-9- 000	8414419376199	 x10 	8414419822191
3771	 Colgador madera de pino 1 pomo - 1 Knob pine wooden hook				
	madera en crudo - raw wood	3771-N- 000	8414419016064	 x6 	8414419844254
	wengué - wengue	3771-0- 000	8414419377103	 x6 	8414419844179
	blanco - white	3771-2- 000	8414419377127	 x6 	8414419844193
	natural - natural	3771-8- 000	8414419377189	 x6 	8414419844216
	miel - honey brown	3771-9- 000	8414419377196	 x6 	8414419844230
3772	 Colgador madera de pino 2 pomos - 2 knobs pine wood hook rack				
	madera en crudo - raw wood	3772-N- 000	8414419016040	 x4 	8414419843950
	wengué - wengue	3772-0- 000	8414419377202	 x4 	8414419843875
	blanco - white	3772-2- 000	8414419377226	 x4 	8414419843899
	natural - natural	3772-8- 000	8414419377288	 x4 	8414419843912
	miel - honey brown	3772-9- 000	8414419377295	 x4 	8414419843936
3773	 Colgador madera de pino 3 pomos - 3 knobs pine wood hook rack				
	madera en crudo - raw wood	3773-N- 000	8414419016057	 x4 	8414419844056
	wengué - wengue	3773-0- 000	8414419377301	 x4 	8414419843974
	blanco - white	3773-2- 000	8414419377325	 x4 	8414419843998
	natural - natural	3773-8- 000	8414419377387	 x4 	8414419844018

MODELO MODEL	COLOR COLOUR	ARTÍCULO ARTICLE	EAN ARTÍCULO EAN ARTICLE	EMBALAJE PACKING	EAN EMBALAJE EAN PACKING
	miel - honey brown	3773-9- 000	8414419377394	 x4	 1 8414419844032
3774	 Colgador madera de pino 4 pomos - 4 knobs pine wood hook rack				
	madera en crudo - raw wood	3774-N- 000	8414419016071	 x4	 1 8414419844155
	wengué - wengue	3774-0- 000	8414419377400	 x4	 1 8414419844070
	blanco - white	3774-2- 000	8414419377424	 x4	 1 8414419844094
	natural - natural	3774-8- 000	8414419377486	 x4	 1 8414419844117
	miel - honey brown	3774-9- 000	8414419377493	 x4	 1 8414419844131
3800	 Anillas amortiguadoras Ø 17 mm - Dampening O-Rings Ø 17 mm				
	negro - black	3800-3- 000	8414419380035	 x20	 5 8414419838901
	negro - black	3800-3G 000		 x50	 4 8414419838925
4001	 Fieltro lana adhesivo Ø 17 mm - Adhesive woollen felt Ø17 mm.				
	blanco - white	4001-2- 000	8414419400122	 x22	 20 8414419809642
	marrón - brown	4001-4- 000	8414419400146	 x22	 20 8414419809659
4002	 Fieltro lana adhesivo Ø 22 mm - Adhesive woollen felt Ø22 mm.				
	blanco - white	4002-2- 000	8414419400221	 x22	 12 8414419809666
	marrón - brown	4002-4- 000	8414419400245	 x22	 12 8414419809673
4003	 Fieltro lana adhesivo Ø 27 mm - Adhesive woollen felt Ø27 mm.				
	blanco - white	4003-2- 000	8414419400320	 x22	 8 8414419809680
	marrón - brown	4003-4- 000	8414419400344	 x22	 8 8414419809697
4004	 Fieltro lana adhesivo 17 x 17 mm - Adhesive woollen felt 17x17 mm.				
	blanco - white	4004-2- 000	8414419400429	 x22	 20 8414419809703
	marrón - brown	4004-4- 000	8414419400443	 x22	 20 8414419809710
4005	 Fieltro lana adhesivo 22 x 22 mm - Adhesive woollen felt 22x22 mm.				
	blanco - white	4005-2- 000	8414419400528	 x22	 12 8414419809727
	marrón - brown	4005-4- 000	8414419400542	 x22	 12 8414419809734
4006	 Fieltro lana adhesivo 29 x 23 mm - Adhesive woollen felt 29x23 mm.				
	blanco - white	4006-2- 000	8414419400627	 x22	 9 8414419809741
	marrón - brown	4006-4- 000	8414419400641	 x22	 9 8414419809758
4007	 Fieltro lana adhesivo 95 x 12 mm - Adhesive woollen felt 95x12mm.				
	blanco - white	4007-2- 000	8414419400726	 x22	 5 8414419809765
	marrón - brown	4007-4- 000	8414419400740	 x22	 5 8414419809772
4008	 Fieltro lana adhesivo 100 x 85 mm - Adhesive woollen felt 100x85 mm.				

MODELO MODEL	COLOR COLOUR	ARTÍCULO ARTICLE	EAN ARTÍCULO EAN ARTICLE	EMBALAJE PACKING	EAN EMBALAJE EAN PACKING
	blanco - white	4008-2- 000	8414419400825	 x22 	8414419809789
	marrón - brown	4008-4- 000	8414419400849	 x22 	8414419809796
4009	 Fieltro lana adhesivo Ø 34 mm - Adhesive woollen felt Ø34 mm.				
	blanco - white	4009-2- 000	8414419400924	 x22 	8414419809802
	marrón - brown	4009-4- 000	8414419400948	 x22 	8414419809819
4010	 Fieltro lana adhesivo 1000 x 85 mm. - Adhesive woollen felt 1000x85 mm.				
	blanco - white	4010-2- 000	8414419401020	 x10 	8414419807334
	marrón - brown	4010-4- 000	8414419401044	 x10 	8414419807341
4011	 Fieltro lana adhesivo Ø 9 mm - Adhesive woollen felt Ø9 mm.				
	blanco - white	4011-2- 000	8414419401129	 x22 	8414419809918
	marrón - brown	4011-4- 000	8414419401143	 x22 	8414419809925
4013	 Fieltro lana adhesivo Ø 38 mm - Adhesive woollen felt Ø38 mm.				
	blanco - white	4013-2- 000	8414419401327	 x22 	8414419809871
	marrón - brown	4013-4- 000	8414419401341	 x22 	8414419809888
4014	 Fieltro lana adhesivo 31x31 mm - Adhesive woollen felt 31x31 mm.				
	blanco - white	4014-2- 000	8414419401426	 x22 	8414419809895
	marrón - brown	4014-4- 000	8414419401440	 x22 	8414419809901
4018	 Fieltro lana adhesivo 100 x 85 mm - Adhesive woollen felt 100x85 mm.				
	blanco - white	4018-2- 000	8414419401822	 x10 	8414419807372
	marrón - brown	4018-4- 000	8414419401846	 x10 	8414419807389
4030	 Antideslizante adhesivo 17x17 mm - Adhesive non-slip foam 17x17 mm.				
	negro - black	4030-3- 000	8414419403031	 x22 	8414419809031
4031	 Antideslizante adhesivo 100 x 85 mm - Adhesive non-slip foam 100x85 mm.				
	negro - black	4031-3- 000	8414419403130	 x22 	8414419809048
4033	 Antideslizante adhesivo Ø 17 mm - Adhesive non-slip foam Ø17 mm.				
	negro - black	4033-3- 000	8414419403338	 x22 	8414419809055
4050	 Gota adhesiva Ø 8 x 2,2 mm - Adhesive buffer Ø 8 x 2,2 mm				
	transparente - transparent	4050-2- 000	8414419405028	 x20 	8414419807457
4051	 Gota adhesiva Ø 12,7 x 3,5 mm - Adhesive buffer Ø 12,7 x 3,5 mm				
	transparente - transparent	4051-2- 000	8414419405127	 x20 	8414419807464
4052	 Gota adhesiva Ø 16 x 7,9 mm - Adhesive buffer Ø 16 x 7,9 mm				































MODELO MODEL	COLOR COLOUR	ARTÍCULO ARTICLE	EAN ARTÍCULO EAN ARTICLE	EMBALAJE PACKING	EAN EMBALAJE EAN PACKING
	transparente - transparent	4052-2- 000	8414419405226	 x20	 6 8414419807471
4053	 Gota adhesiva Ø 19 x 4 mm - Adhesive buffer Ø 19 x 4 mm				
	transparente - transparent	4053-2- 000	8414419405325	 x20	 4 8414419807488
4054	 Gota adhesiva 12,7 x 12,7 x 3,1 mm - Adhesive buffer 12,7 x 12,7 x 3,1 mm				
	transparente - transparent	4054-2- 000	8414419405424	 x20	 12 8414419807495
4055	 Gota adhesiva 20,5 x 20,5 x 7,6 mm. - Adhesive buffer 20,5 x 20,5 x 7,6 mm				
	transparente - transparent	4055-2- 000	8414419405523	 x20	 6 8414419807501
4056	 Gotas adhesivas formato multifigura (36 figuras) - Multi shape adhesive buffers				
	transparente - transparent	4056-2- 000	8414419405622	 x10 	8414419843349
4060	 Amortiguador adhesivo - Door damper				
	blanco - white	4060-2- 001	8414419014855	 x20	 18 8414419838369
	marrón - brown	4060-4- 001	8414419014886	 x20	 18 8414419838383
4071	 Filtro sintético adhesivo Ø 17 mm - Adhesive synthetic felt Ø17 mm.				
	blanco - white	4071-2- 000	8414419407121	 x22	 20 8414419800465
	marrón - brown	4071-4- 000	8414419407145	 x22	 20 8414419800496
4072	 Filtro sintético adhesivo Ø 22 mm - Adhesive synthetic felt Ø22 mm.				
	blanco - white	4072-2- 000	8414419407220	 x22	 12 8414419800526
	marrón - brown	4072-4- 000	8414419407244	 x22	 12 8414419800557
4073	 Filtro sintético adhesivo Ø 27 mm - Adhesive synthetic felt Ø27 mm.				
	blanco - white	4073-2- 000	8414419407329	 x22	 8 8414419800588
	marrón - brown	4073-4- 000	8414419407343	 x22	 8 8414419800618
4074	 Filtro sintético adhesivo 17 x 17 mm - Adhesive synthetic felt 17x17 mm.				
	blanco - white	4074-2- 000	8414419407428	 x22	 20 8414419800649
	marrón - brown	4074-4- 000	8414419407442	 x22	 20 8414419800670
4075	 Filtro sintético adhesivo 22 x 22 mm - Adhesive synthetic felt 22x22 mm.				
	blanco - white	4075-2- 000	8414419407527	 x22	 12 8414419800700
	marrón - brown	4075-4- 000	8414419407541	 x22	 12 8414419800731
4076	 Filtro sintético adhesivo 29 x 23 mm - Adhesive synthetic felt 29x23 mm.				
	blanco - white	4076-2- 000	8414419407626	 x22	 9 8414419800762
	marrón - brown	4076-4- 000	8414419407640	 x22	 9 8414419800793
4077	 Filtro sintético adhesivo 95 x 12 mm - Adhesive synthetic felt 95x12 mm.				

MODELO MODEL	COLOR COLOUR	ARTÍCULO ARTICLE	EAN ARTÍCULO EAN ARTICLE	EMBALAJE PACKING	EAN EMBALAJE EAN PACKING
	blanco - white	4077-2- 000	8414419407725	 x22  5	8414419800823
	marrón - brown	4077-4- 000	8414419407749	 x22  5	8414419800854
4078		Fieltro sintético adhesivo 100 x 85 mm - Adhesive synthetic felt 100x85 mm.			
	blanco - white	4078-2- 000	8414419407824	 x22  1	8414419800885
	marrón - brown	4078-4- 000	8414419407848	 x22  1	8414419800915
4079		Fieltro sintético adhesivo Ø 34 mm - Adhesive synthetic felt Ø34 mm.			
	blanco - white	4079-2- 000	8414419407923	 x22  5	8414419800946
	marrón - brown	4079-4- 000	8414419407947	 x22  5	8414419800977
4080		Fieltro sintético 1000 x 85 mm - Adhesive synthetic felt 1000x85 mm.			
	blanco - white	4080-2- 000	8414419408029	 x10  1	8414419807730
	marrón - brown	4080-4- 000	8414419408043	 x10  1	8414419807747
4081		Fieltro sintético adhesivo 200 x 500 mm - Adhesive synthetic felt 200x500 mm.			
	marrón - brown	4081-4- 000	8414419408142	 x5  1	8414419809949
4082		Fieltro sintético adhesivo 25 x 1500 mm - Adhesive synthetic felt 25x1500 mm.			
	marrón - brown	4082-4- 000	8414419408241	 x13  1	8414419809956
4083		Fieltro sintético adhesivo Ø 38 mm - Adhesive synthetic felt Ø38 mm.			
	blanco - white	4083-2- 000	8414419408326	 x22  4	8414419800342
	marrón - brown	4083-4- 000	8414419408340	 x22  4	8414419800373
4084		Fieltro sintético adhesivo 31x31 mm - Adhesive synthetic felt 31x31 mm.			
	blanco - white	4084-2- 000	8414419408425	 x22  6	8414419800403
	marrón - brown	4084-4- 000	8414419408449	 x22  6	8414419800434
4088		Fieltro sintético adhesivo 100 x 85 mm - Adhesive synthetic felt 100x85 mm.			
	blanco - white	4088-2- 000	8414419408821	 x10  4	8414419807792
	marrón - brown	4088-4- 000	8414419408845	 x10  4	8414419807808
4089		Fieltro sintético adhesivo multiforma - Multi shape synthetic adhesive felt			
	marrón - brown	4089-4- 000	8414419408944	 x20  3	8414419837805
4101		Protector parking para cantos - Parking protector for edges			
	rojo-blanco - red-white	4101-1- 000	8414419410114	 x60  1	8414419841116
4102		Protector parking para columna - Parking protector for column			
	rojo-blanco - red-white	4102-1- 000	8414419410213	 x62  1	8414419841109
4103		Protector parking frontal - Frontal parking protector			

MODELO MODEL	COLOR COLOUR	ARTÍCULO ARTICLE	EAN ARTÍCULO EAN ARTICLE	EMBALAJE PACKING	EAN EMBALAJE EAN PACKING
	rojo-blanco - red-white	4103-1- 000	8414419410312	 x30 	8414419841123
4104	 Protector parking lateral - Lateral parking protector				
	rojo-blanco - red-white	4104-1- 000	8414419410411	 x50 	8414419841154
4105	 Protector parking en rollo 2m. - Parking protector 2m. roll				
	rojo-blanco - red-white	4105-1- 000	8414419410510	 x30 	8414419841130
5000	 Protector de cantos - Corner guard				
	transparente - transparent	5000-0- 001	8414419012578	 x12 	8414419832558
5001	 Protector de cantos - Corner guard				
	transparente - transparent	5001-0- 001	8414419012585	 x12 	8414419832572
5002	 Protector de cantos acolchado - Padded corner guard				
	blanco - white	5002-2- 001	8414419012592	 x6 	8414419832596
	marrón - brown	5002-4- 001	8414419012608	 x6 	8414419832619
5003	 Rollo protector de cantos acolchado (2 m) - Padded edge guard (2 m roll)				
	blanco - white	5003-2- 001	8414419012653	 x6 	8414419832633
	marrón - brown	5003-4- 001	8414419012660	 x6 	8414419832657
5004	 Rollo protector de cantos acolchado (2 m.) + 4 esquineras - Padded edge guard (2m roll) + 4 corner				
	blanco - white	5004-2- 001	8414419012677	 x6 	8414419832671
	marrón - brown	5004-4- 001	8414419012684	 x6 	8414419832695
5100	 Cierre seguridad multiuso largo - Long multipurpose safety lock				
	blanco - white	5100-2- 001	8414419012691	 x6 	8414419832718
5101	 Cierre seguridad multiuso corto - Short multipurpose safety lock				
	blanco - white	5101-2- 001	8414419012707	 x6 	8414419832732
5102	 Cierre seguridad multiuso ajustable - Adjustable multipurpose safety lock				
	blanco - white	5102-2- 001	8414419012714	 x6 	8414419832756
5103	 Cierre seguridad lateral - Lateral safety lock				
	blanco - white	5103-2- 001	8414419012721	 x6 	8414419832770
5104	 Cierre seguridad lateral con pestillo - Lateral safety lock with latch				
	blanco - white	5104-2- 001	8414419012738	 x6 	8414419832794
5105	 Cierre seguridad frontal - Exterior safety lock				
	blanco - white	5105-2- 001	8414419012745	 x6 	8414419832817

MODELO MODEL	COLOR COLOUR	ARTÍCULO ARTICLE	EAN ARTÍCULO EAN ARTICLE	EMBALAJE PACKING	EAN EMBALAJE EAN PACKING
5106		Cierre de seguridad para armarios - Safety slide lock for cabinets			
	blanco - white	5106-2- 001	8414419012752	 x6 	8414419832831
5107		Cierre seguridad interno para armarios y cajones - Interior safety lock for cabinets-drawer			
	blanco - white	5107-2- 001	8414419012769	 x6 	8414419832855
5110		Protector adhesivo acolchado para cantos y paredes - Adhesive padded edge and wall guard			
	blanco - white	5110-2- 000	8414419511026	 x6 	8414419840256
5200		Tope salva dedos para puertas - Finger guard for doors			
	blanco - white	5200-2- 001	8414419012776	 x8 	8414419832879
5201		Bloqueador puerta o ventana corredera - Safety block for sliding doors & windows			
	blanco - white	5201-1- 001	8414419012783	 x6 	8414419832893
5203		Retenedor de puerta flexible - Door flexible retainer			
	transparente - transparent	5203-0- 000	8414419013407	 x6 	8414419832404
	blanco - white	5203-2- 000	8414419520325	 x6 	8414419831698
5210		Tope salva dedos para puertas - Finger guard for doors			
	surtido - assortment	5210-0- 001	8414419012783	 x8 	8414419832916
		incluye modelos 5211-5212-5213-5214 - models included 5211-5212-5213-5214			
5211		Tope salva dedos para puertas - Finger guard for doors			
	marrón - brown	5211-4- 001	8414419012622	 x8 	8414419832930
5212		Tope salva dedos para puertas - Finger guard for doors			
	rojo - red	5212-6- 001	8414419012639	 x8 	8414419832954
5213		Tope salva dedos para puertas - Finger guard for doors			
	azul - blue	5213-7- 001	8414419012646	 x8 	8414419832978
5214		Tope salva dedos para puertas - Finger guard for doors			
	amarillo - yellow	5214-9- 001	8414419012615	 x8 	8414419832992
5301		Discos adhesivos antiresbalones Ø 38 mm. - Adhesive non-slip pads			
	transparente - transparent	5301-0- 001	8414419012851	 x10 	8414419833012
5302		Figuras adhesivas anti-resbalones. Pez - Adhesive non-slip figures. Fish			
	transparente - transparent	5302-0- 000	8414419530201	 x10 	8414419840201
5304		Figuras adhesivas anti-resbalones. Pato - Adhesive non-slip figures. Duck			
	transparente - transparent	5304-0- 000	8414419530409	 x10 	8414419840225

MODELO MODEL	COLOR COLOUR	ARTÍCULO ARTICLE	EAN ARTÍCULO EAN ARTICLE	EMBALAJE PACKING	EAN EMBALAJE EAN PACKING
5305		Termómetro digital cocodrilo para bañera/baño - Crocodile digital thermometer for bathtub			
	verde - green	5305-3- 000	8414419530539	 x6 	8414419840232
5306		Termómetro digital patito para bañera/baño - Duckling digital thermometer for bathtub			
	amarillo - yellow	5306-8- 000	8414419530683	 x6 	8414419840324
5307		Cesta de malla con ventosa 43x53cm - Mesh bag with suction cup 43 x 53 cm			
	blanco - white	5307-2- 000	8414419530720	 x6 	8414419840249
5400		Protector giratorio adhesivo de enchufes - Adhesive swivel socket cover			
	blanco - white	5400-2- 001	8414419012790	 x10 	8414419833036
5401		Protector para enchufe - Socket cover			
	blanco - white	5401-2- 000	8414419540125	 x10 	8414419838864
5502		Ganchos giratorio para cochecito bebé - Swivel hooks for baby stroller			
	negro - black	5502-3- 000	8414419550230	 x6 	8414419840300
5503		Mosquetón para cochecito bebé - Multi-purpose carabiner for baby stroller			
	negro - black	5503-3- 000	8414419550339	 x6 	8414419840317
7000		Identificador de cables - Cable tag			
	surtido - assortment	7000-0- 000	8414419700000	 x12 	8414419844315
7001		Protector para cable USB y microUSB - Spiral protector for USB and micro-USB cables			
	blanco-negro - white-black	7001-2- 000	8414419700123	 x12 	8414419844339
7002		Bridas textiles para cables - Fabric cable ties			
	surtido - assortment	7002-0- 000	8414419700208	 x12 	8414419844353
7003		Agrupador de cables flexible 3m. - 3 m. Flexible cable bundler			
	blanco - white	7003-2- 000	8414419700321	 x6 	8414419848238
	negro - black	7003-3- 000	8414419700338	 x6 	8414419844377
7004		Malla agrupadora de cables 1,5m. - 1,5 m. Braided cable sleeving			
	negro - black	7004-3- 000	8414419700437	 x10 	8414419844391
7005		Bridas reutilizables Magic Tie 15cm. - Magic Tie 15-cm reusable cable ties			
	surtido - assortment	7005-0- 000	8414419700505	 x12 	8414419844414
7006		Bridas reutilizables Magic Tie 25cm. - Magic Tie 25-cm reusable cable ties			
	negro - black	7006-0- 000	8414419700604	 x12 	8414419844438
7100		Mini Clip adhesivo para cables - Mini adhesive cable clip organiser			

MODELO MODEL	COLOR COLOUR	ARTÍCULO ARTICLE	EAN ARTÍCULO EAN ARTICLE	EMBALAJE PACKING	EAN EMBALAJE EAN PACKING
	transparente - transparent	7100-0- 000	8414419710009	 x10	 8414419844452
	blanco-negro - white-black	7100-1- 000	8414419710016	 x10	 8414419844476
7101	 Clip adhesivo para cables - Adhesive cable clip organiser				
	transparente - transparent	7101-0- 000	8414419710108	 x10	 6 8414419844490
	blanco-negro - white-black	7101-1- 000	8414419710115	 x10	 6 8414419844513
7102	 Clip adhesivo doble para cables - Double adhesive cable clip organiser				
	surtido - assortment	7102-0- 000	8414419710207	 x10	 4 8414419844537
7103	 Clip adhesivo múltiple para cables - Multiple adhesive cable clip organiser				
	blanco - white	7103-2- 000	8414419710320	 x10	 2 8414419844551
	negro - black	7103-3- 000	8414419710337	 x10	 2 8414419844575
7107	 Clip para cables triple - Triple cable clip				
	blanco - white	7107-2- 000	8414419710726	 x10	 1 8414419844650
	negro - black	7107-3- 000	8414419710733	 x10	 1 8414419844674
7200	 Raspa recogedora de cables - Fishbone cable organiser				
	surtido - assortment	7200-0- 000	8414419720008	 x12	 3 8414419844698
7300	 Soportes para ordenador portátil - Laptop feet				
	gris - grey	7300-3- 000	8414419730038	 x12	 4 8414419844711
7500	 Soporte adhesivo para enchufe - Adhesive plug holder				
	blanco - white	7500-2- 000	8414419750029	 x10	 2 8414419844735

SaintGenis⁰⁰⁰

Polígono industrial El Grab
Ctra. N-340 Km. 1240
08758 Cervelló
(Barcelona-España)

tel. +34 93 684 26 57
fax. +34 93 660 35 51

info@inofix.com
www.inofix.com

© SAINT GENIS S.A. 2024

